

MITSUBISHI

Refrigerator-Freezer

MR-CU415X

MR-CU375X



OPERATING
INSTRUCTIONS



Easy Refrigerator Use

Contents

Before using your refrigerator

From installation to operation 2

Smart tips for using your refrigerator

Adjusting the temperature 3

Using each compartment

Refrigerator and sliding case compartments 4

Vegetable and freezer compartments 5

Automatic icemaker 6

Maintenance and troubleshooting

Removing and maintaining the accessories 8

What to do (during blackouts, long periods of non use, and transport) 9

Maintaining the automatic icemaker 10

Troubleshooting 11

Safety precautions 12

Accessories 14

MEMO 15

- Please read this manual carefully and follow the information contained within. In particular, be sure to read the safety precautions before using this refrigerator.
- Be sure to receive your copy of the warranty from the retailer and confirm that the purchase date and retailer name are written on the warranty.
- Store this operating instructions manual and the warranty in a safe place.

- This refrigerator was manufactured for refrigerating and freezing of foods in general households. For commercial use, please use a commercial refrigerator-freezer.
- The photographs and illustrations contained in this manual are for the MR-CU415X. While the capacity and dimensions of the MR-CU415X are different from the MR-CU375X, the operation is the same.
- The principal plastic components indicate the material name to facilitate recycling.

From Installation to Operation

Installation location

The installation location should be a well-ventilated area out of direct sunlight and not exposed to hot air to avoid diminished cooling power and to economize on electricity costs.

Low humidity is recommended to prevent rusting.

Strong and level location

is recommended to prevent vibration and noise.

- If the refrigerator is installed on flooring on which the refrigerator supports easily sink (such as carpeting, woven mats, polyvinyl chloride flooring, etc.), place a strong plate or board under the refrigerator. (This is necessary to prevent deformation or discoloration due to heat.)

Away from other household appliances

is recommended to prevent noise or image interference with televisions, etc.

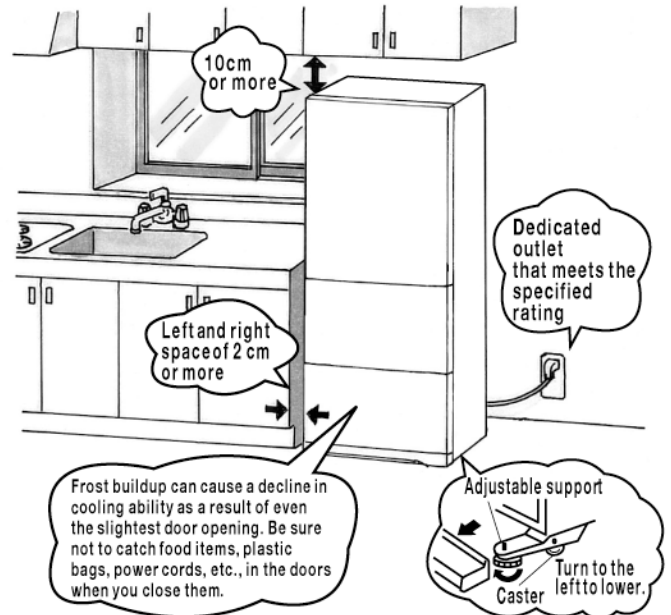

Leave space for heat ventilation

Leave at least 2 cm of space to the left and right of the refrigerator and at least 10 cm of space above the refrigerator to allow heat to escape from above and to the sides of the refrigerator.

The exterior of the refrigerator gets hot

When the refrigerator is first used and during the summer, the exterior temperature can exceed 50–60°C.

Adjust supports for level installation

Turn the adjustable supports located at the bottom front of the refrigerator until the casters are raised from the floor to prevent vibration, noise, refrigerator movement, and doors that do not close properly.

Caution

If the refrigerator is not installed properly, it can move and cause injury.

Keep the refrigerator horizontal left to right but raise the front slightly so that the door closes easily to prevent it from being ajar.

Electrical Connections

Make sure this unit is properly grounded.

- The unit should always be plugged into its own electrical outlet. This will provide the best performance and prevent electrical circuits from being overloaded and causing a fire. Make sure that the electrical outlet provides the proper voltage. Extension cords are not recommended.
- If the power cord is damaged, call our MITSUBISHI SERVICE CENTRE for the replacement, in order to avoid a hazard.
- This refrigerator uses flammable foaming gas for insulation.
- Please deliver the unit to specialized industrial waste dealer when you wish to dispose of it.
- Please follow the rules in your country.

Leveling the door

If the installation location of the refrigerator is not level and the supports sink due to the weight of the food contained within, the door can appear to tilt down. Depending on which side is tilted down, adjust the support indicated in the figure to the right in the direction shown.

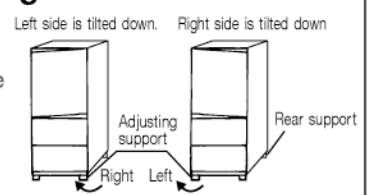

If the refrigerator is installed in a location such as the corner of a room, one of the rear supports may sink into the floor. If this occurs, place a strong plate or board under the rear support.

Use a dedicated outlet

Use a dedicated outlet for the power supply that meets the rating specified on the rating label. (The rating label is located on the door-liner of the refrigerator compartment.)

Warning

Using outlets that do not meet the specified rating or plugging in too many leads into a single socket can cause heat build up or fire.

How to remove the energy label

- Remove the energy label carefully. A glue residue may remain, particularly if the label has been in place for a long period of time.
- Apply either Eucalyptus or Tea Tree oil directly on any residue.
- Do not allow the oil to run or drip onto plastic parts as it may cause the plastic to degrade and potentially crack over time.
- Allow the oil to sit for approximately 1-2 minutes, or until the glue residue has softened.
- Wipe off with a damp cloth.
- If any residue remains, repeat the above process.
- Rinse with clear water.
- Dry thoroughly.

Adjusting the Temperature

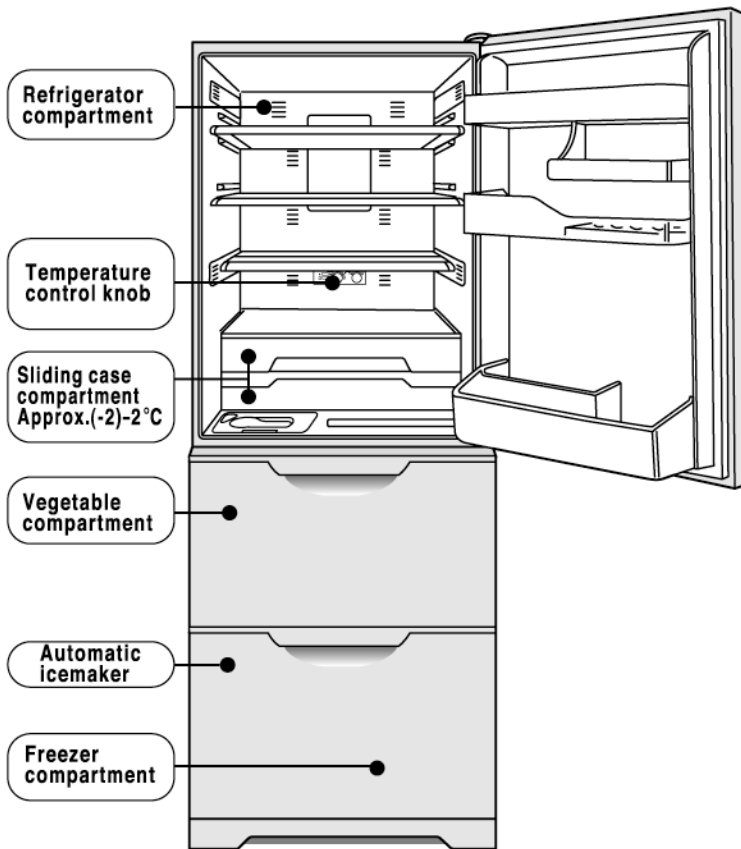

- The temperatures listed above for the refrigerator and freezer compartments represent the temperatures measured roughly at the lower center of each compartment with the temperature control knob set between the HI and LOW settings, the refrigerator empty, the doors closed, and a stable, ambient temperature of 30 °C.

To ensure quick cooling

The refrigerator will not immediately cool after power is turned on. It normally takes 4–5 hours for the refrigerator to cool.

- Leave space between food items.
- Allow the refrigerator to cool sufficiently before you store non-cooled food items or ice cream.
- Open and close the doors only as much as necessary and do not leave them open for long periods of time.

Especially during hot summers, it may take 24 hours to make the first batch of ice.

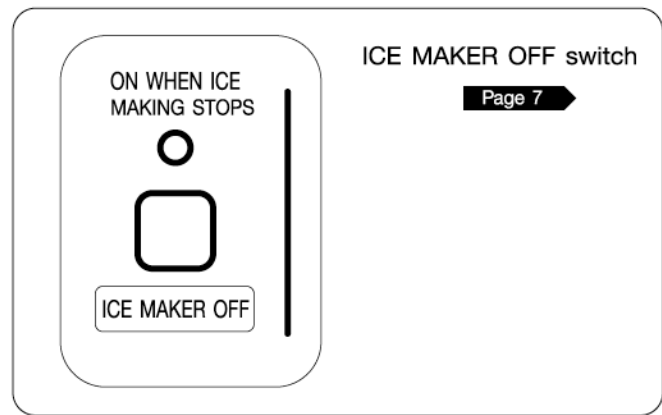

When the refrigerator compartment cools excessively, adjust the temperature control knob to MID. For additional cooling, adjust the knob to COLDER.

Normally set "MID"

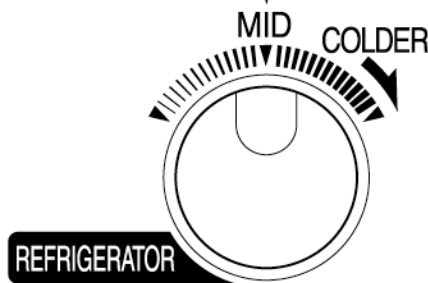

When the freezer compartment freeze's excessively, adjust the temperature control knob to MID. For additional freezing, adjust the knob to COLDER.

Normally set "MID"

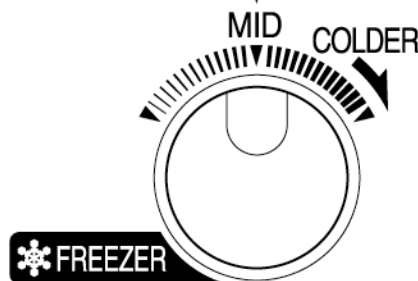

- The temperatures within the sliding case and vegetable compartments change along with the temperature adjustments to the refrigerator compartment.

Using Each Compartment Refrigerator Compartment

Using each compartment Refrigerator compartment

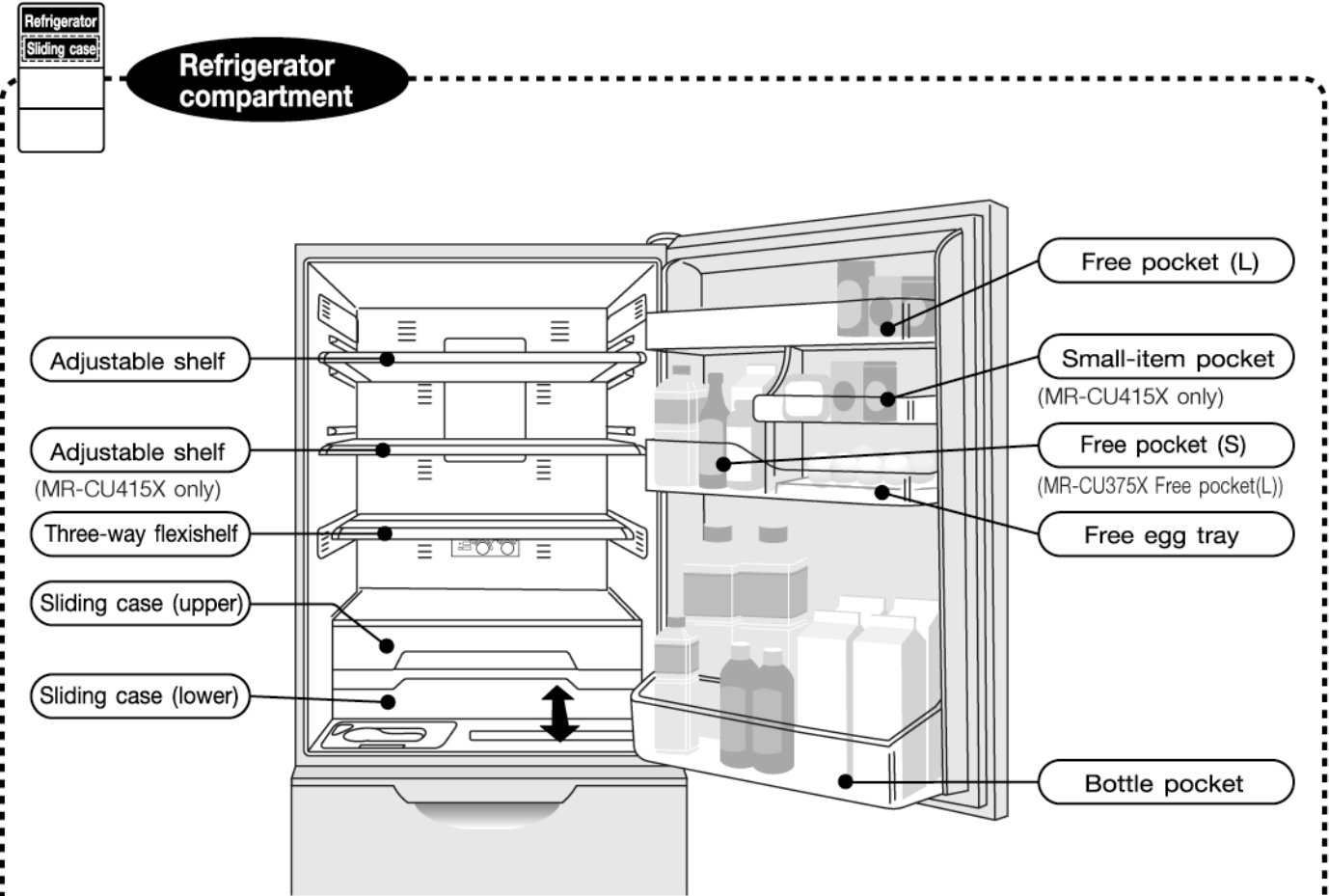

Adjust the positions of the shelves to maximize storage space!

Adjustable shelf

Change the position of the shelf to adjust the shelf spacing.

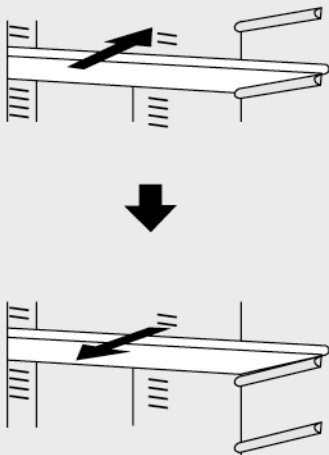

You can even chill an entire large watermelon.

Three-way flexishelf

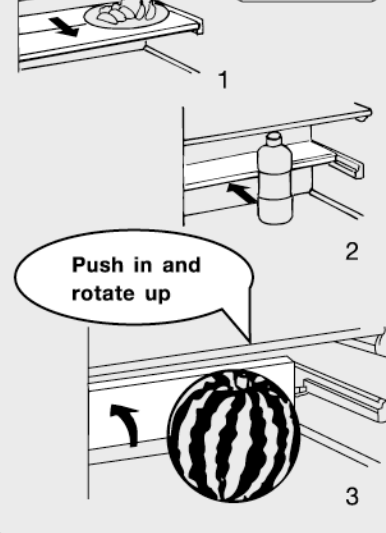

Use to store eggs and small items. Flip it over to use 2 ways!

Free egg tray

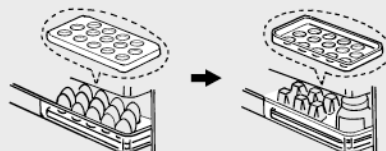

Notes

- Do not leave food items hanging over the edge of each shelf.
- Do not place bottles or other items in the front of the bottle pocket that do not fit completely in the pocket. (This can cause the door to be ajar or damage the bottle.)
- Do not close the refrigerator door with items left in front of the sliding case. This can cause a decline in cooling ability as a result of the door being ajar and also cause food items to fall, injury, or damage to the sliding case.
- Place items completely in the sliding case. If not completely closed, the door may hit the sliding case and damage it.
- Install the tube stand on the inside of the bottle pocket. (If the tube stand is installed on the outside of the bottle pocket, it may prevent the door from closing completely.)



Using Each Compartment Vegetable and Freezer Compartments

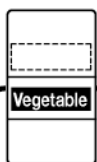

Vegetable compartment

Sliding case

Use for small items such as tomatoes and fruits that are easily damaged.

Vegetable case

Can be used for 2-litre plastic bottles.

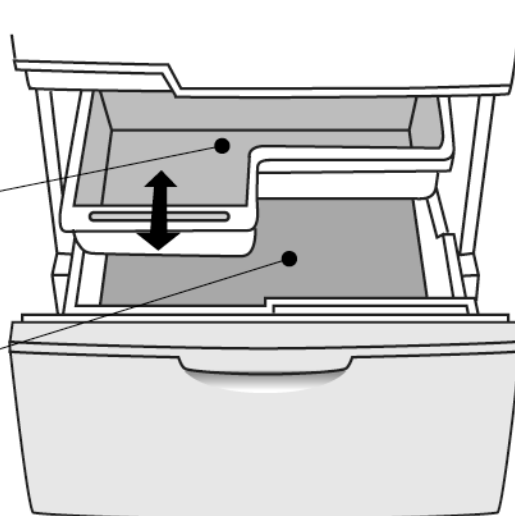

Note

Do not place tall items underneath the sliding case.

- Doing so can cause damage to the food items and the sliding case.
- Using the vegetable compartment without the sliding case will cause the vegetables to dehydrate.

User tip

- Wrap fruits and vegetables in plastic wrap to preserve the freshness longer.

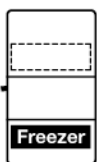

Freezer compartment

Freezing case (upper)

Freezing case (lower)

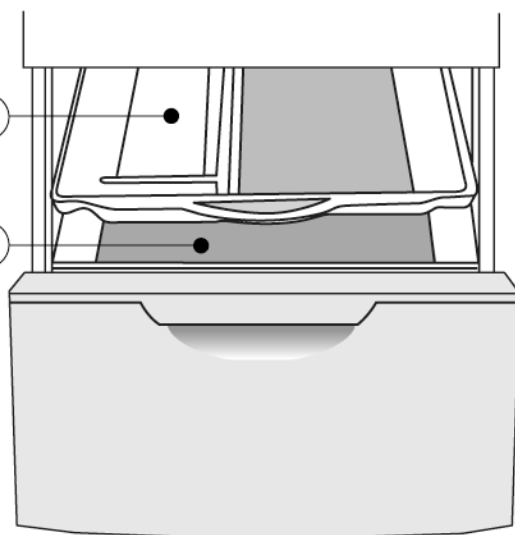

Note

Do not place tall items underneath the upper freezing case.

- Doing so can cause damage to the food items and the upper freezing case. Do not place commercial cooling packs (including those containing ammonium nitrate and carbamide) in the freezer compartment.
- The contents can cause rust and prevent the freezer compartment from operating properly if they leak.

Using Each Compartment Automatic Icemaker

Using each compartment Automatic icemaker

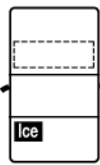

Automatic icemaker

- Water tank** Approx. 1.1 liters, includes a purification filter.
- Ice tray (inside the ice storage bin)** Cannot be removed.
- Soundproofing mat** Reduces the sound of ice dropping into the storage bin. Do not remove the mat.
- Ice storage bin**
- Ice server**

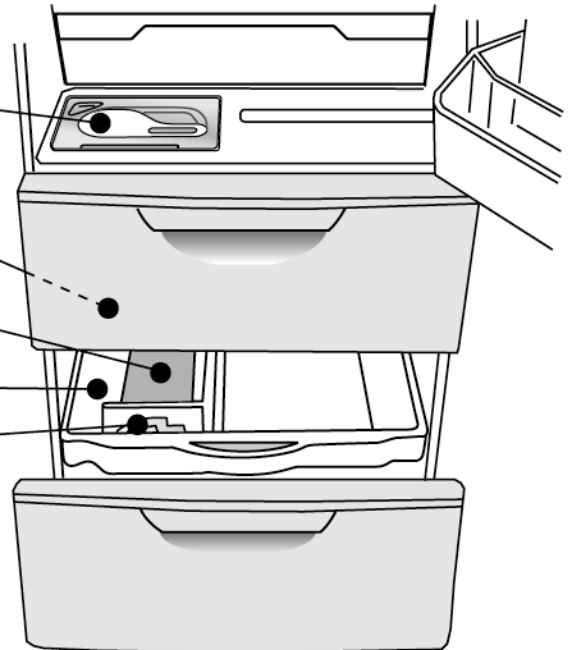

Automatic icemaker water

It is recommended that you use water that has been disinfected such as tap water.

If you use mineral water or water from a purifier, use special care and clean the icemaker more often.

Your first batch of ice

If you are first using the icemaker or have not used it for 1 week or longer, discard the first 2-3 batches of ice (about 30 cubes).

This ice may have a bad odor or contain dust.

Making ice

1

Remove the water tank from the refrigerator, remove the water tank cap, and fill the tank with water.

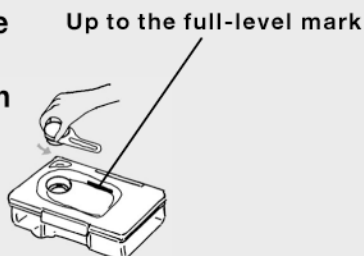

Removing the water tank cap

Slide the ◀ OPEN mark on the cap to OPEN and lift up the cap.

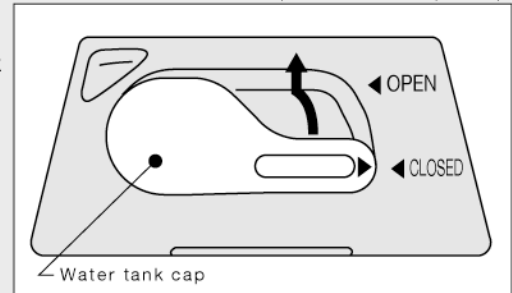

2

Hold the water tank level and place the water tank back into the refrigerator.

- Be sure to align the ▶ mark on the water tank cap with the CLOSED mark.
- Water will spill from the water tank if it is tipped.
- Water will not be supplied from the water tank if it is not installed properly. Be sure to check that there is no foreign material in the tank holder.

Installing the water tank cap

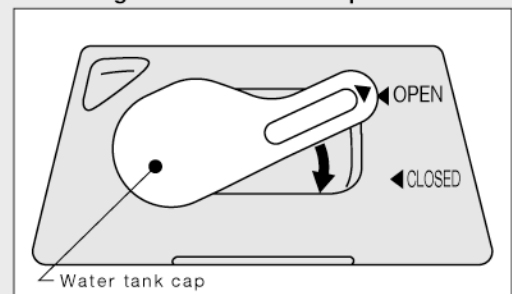

Stopping the automatic icemaker

Press  if the red light is not on.
The red light will come on.

ON WHEN ICE MAKING STOPS

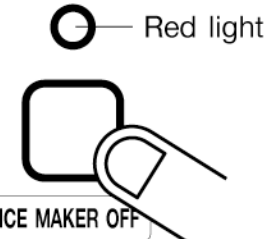

Restarting the automatic icemaker

Press  if the red light is on.
The red light will go off.

Note

Do not place anything deep inside the ice storage bin.

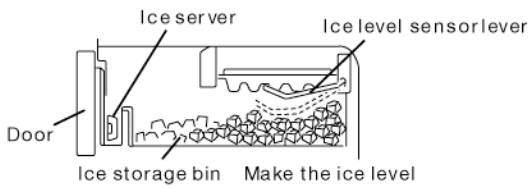

- The sensor lever automatically detects the level of ice in the ice storage bin and stops making ice when the ice has reached a certain level.
Level the ice in the ice storage bin and store the ice server in its holder in the front of the bin so that the level of ice is detected correctly.

Do not fill the water tank with hot water, juice, tea, or soft drinks etc. - use only cold water.

(The water tank is heat resistant up to 60 °C.)

- If anything other than water is added to the water tank, the automatic icemaker and water pump may malfunction.



Do not fill the water tank higher than the full-level mark.

- Filling the water tank above the full-level mark with a kettle, etc., while it is installed in the refrigerator may cause "connected" ice to form.

User tip

- If water with a high mineral content such as mineral water is used to make ice, white sediment (white crystals) may form in the ice. This is the crystallized minerals and is not harmful.
- If the ice is left in the ice storage bin for a long period of time, the ice will stick together and become smaller. (This phenomenon is known as "sublimation.")
- The time required to make ice might be longer depending on the frequency the door is opened and closed and the ambient temperature.



Ice is bumpy, small, melted, or stuck together

- ① The ice cubes are bumpy. 2-3 ice cubes are stuck together.
- ② The ice cubes are small. The surface is melted. The ice cubes are stuck together.



- ① The icemaker tray is equipped with a conduit for even water flow. Do not fill the water tank above the full-level mark. [Page 6](#)
- ② Ice shrinks and gets smaller when it is left for long periods of time. (This phenomenon is known as "sublimation.")

Ice is cloudy or white

- ① Are you using mineral water to make ice?
- ① Mineral water sometimes produces ice with white sediment. This is not harmful.

Removing and Maintaining the Accessories

Before you start

Remove the power cord plug from the outlet.

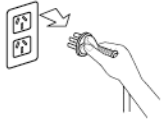

Warning

Failure to remove the power cord plug can cause electric shock.

Wait at least 10 minutes before you plug the power cord plug back into the outlet. The refrigerator will not operate if the plug is reinserted soon after it is removed.

Maintenance and cleaning

- Wipe or remove and wash parts with water.
- To remove oily deposits, wet a cloth with lukewarm water or dishwashing detergent and wipe clean. (Oily deposits left on plastic parts can cause them to break.)
- Be sure to completely wipe off any detergent you use.
- For chemically-treated disposable cloths, be sure to read all of the instructions and observe the precautions.
- Do not use alcohol, benzene, scouring brushes, or alkaline detergent. They can damage the surface of plastic parts (door handles, caps, cases, etc.) and cause them to break.



Refrigerator compartment

Adjustable shelf

Pull the shelf forward and downward.

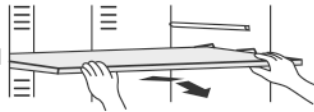

Three-way flexishelf

Push the shelf deep into the compartment and hold it up.

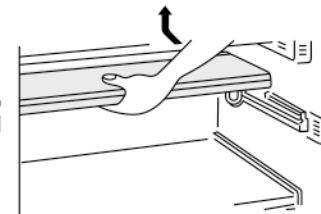

Sliding case

Lift up on the front of the case and pull out.

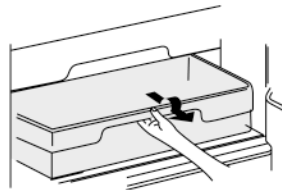

Drain pan

- 1 Remove the toe grille by pressing the left and right sides inward while pulling it out.
- 2 Hold the drain pan with both hands and pull it out gently.

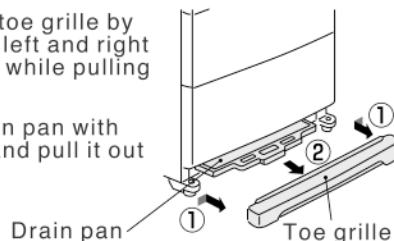

Freezer compartment

- 1 Open the freezer compartment door all the way.
- 2 Lift up and pull the upper freezing case towards you.
- 3 Pull the door towards you while lifting up and let it tilt down.
- 4 Lift up and pull the lower freezing case towards you.

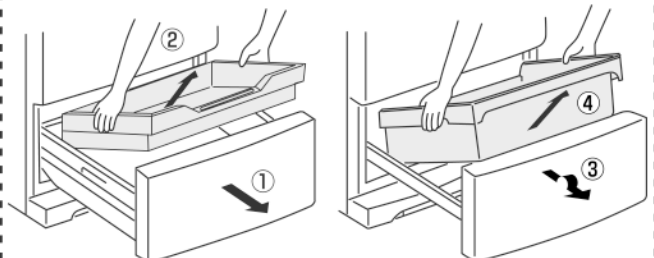

Removing and maintaining the accessories

Reverse the removal procedures to reinstall the accessories.

Door seal

Dirty seals are easily damaged and can allow refrigerated air to leak from the refrigerator.

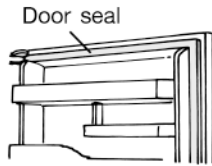

Free pockets and bottle pocket

① Lift up the left and right sides alternately. (The pockets are installed securely.)

② Pull towards you.

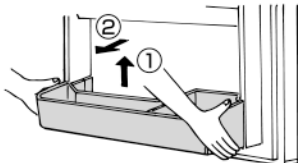

Vegetable compartment

Sliding case

① Open the vegetable compartment door all the way.

② Lift up and pull the sliding case towards you.

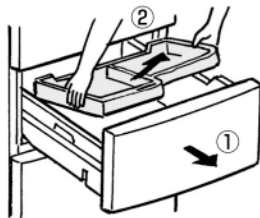

Vegetable case

① Remove the sliding case, and then pull the door towards you while lifting up and let it tilt down.

② Lift up and pull the vegetable case towards you.

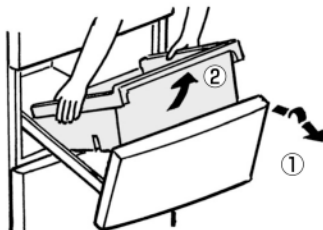

Drip gutters

Wipe away any dirt, liquid, or condensation.

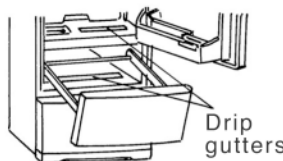

Rear of the refrigerator and floor

① Turn the adjusting supports until they are raised from the floor, and then move the refrigerator.

② Wipe away any dirt from the wall, floor, or rear of the refrigerator. Air circulation can cause dust to collect in the area behind and under the refrigerator. These areas also easily become black.



Caution

Do not put your hands or feet underneath the refrigerator. Doing so can cause injury.

Replacing the interior light bulb

① Remove the adjustable shelves and three-way flexishelf.

② Push the tab with the ▲ mark upward as you pull the cover towards you.

● Purchase a 240V 15W glass light bulb (metal cap E-12) from your refrigerator retailer.

③ Replace the interior light bulb.

④ To reinstall the cover, insert the upper tabs and then the lower tab.



Warning

Using non-specified light bulbs can cause a fire.

After maintenance

Inspecting the power cord, plug, and outlet

- Is the power cord or plug damaged?
- Has dust collected on the power cord plug?
- Is there abnormal heat buildup in the power cord plug?
- Is the outlet loose?
- Is the power cord plug inserted securely into the outlet?



Warning

Damage to the power cord or plug or dust buildup can cause electric shock or a fire.

What to do

◆ Blackouts (electric power goes out)

- Refrain from opening and closing the refrigerator doors and avoid storing additional food items in the refrigerator.

◆ Long periods of nonuse

- Clean the automatic icemaker (page 10). After removing the power cord plug from the outlet, clean the interior of the refrigerator and leave the doors open for 2-3 days to let interior dry completely.
 - ※ Failure to let the interior of the refrigerator dry completely can cause moulding, odors, and refrigerant (gas) leakage due to corrosion of the condenser.

◆ Transporting the refrigerator

1. Discard the water or ice in the water tank and ice tray. [Page 10](#)
2. Discard the water that has collected in the drain pan. [Page 8](#)
3. Gently transport the refrigerator with 2 or more people, holding the lower front interior and the handy-grip recesses on the upper rear of the unit.

- Do not lay the refrigerator down. (Doing so can cause the compressor to malfunction.)

- If changing residences, it is not necessary to change the frequency of the power supply. (Both 50 and 60 Hz are compatible.)



Lower front interior Upper rear handy-grips

Maintaining the Automatic Icemaker

- Reverse the removal procedures to reinstall the automatic icemaker.

Weekly cleaning

Water tank

Remove the cover and wash with water.

(The water tank cover is heat resistant up to 60 °C.)

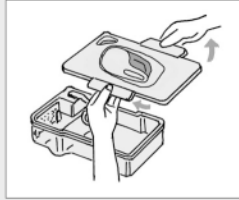

Purification filter

Remove the purification filter and wash with water. The filter does not normally need to be replaced but replacement may be necessary in the following cases:

- The filter is clogged from use of liquids other than water.
- The filter is damaged.

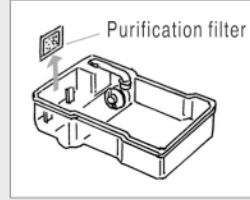

Contact your refrigerator retailer for a replacement filter.

Monthly cleaning

Water pump

1 Pull out the pipe

2 Twist the water pump to remove it.

3 Pull out the pipe, twist the cap to remove it, remove the impeller, and then wash all of the parts with water.

- The impeller is magnetic. Wash carefully with water to remove any foreign material.

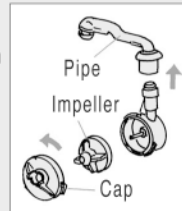
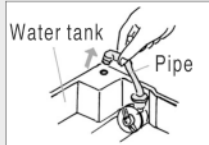

4 Reverse the procedures to assemble and reinstall the water pump.

- Do not forget to install the impeller. Be sure to check that the pipe is fitted securely in place.

Cleaning (rinsing) the ice tray

1 Remove the ice from the ice storage bin, and then close the freezer compartment door.



2 Fill the water tank with water and install it in the refrigerator.

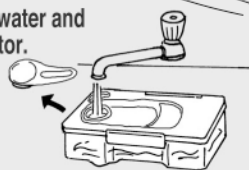

3 Press ICE MAKER OFF near the temperature control knobs for approximately 5 seconds.

- The ICE MAKER OFF light (red) will blink for approximately 1 minute. (The ice tray will be cleaned by the water from the water tank.)
- After the blinking stops, the light will come on or go off according to the previous setting.

4 Repeat step **3**, 2–3 times.

5 Remove the upper freezing case and discard any water or ice.



When the automatic icemaker will not be used for a long period of time

※ Follow these instructions for transport of the refrigerator as well.

Deposit all ice or water from the ice tray into the ice storage bin to empty the ice tray.

1 Remove the water tank and close the freezer compartment door.



2 Press ICE MAKER OFF near the temperature control knobs for approximately 5 seconds.

- The ICE MAKER OFF light (red) will blink for approximately 1 minute. (The ice or water in the ice tray will drop into the ice storage bin.)
- After the blinking stops, the light will come on or go off according to the previous setting.

3 Remove the upper freezing case and discard any water or ice.



4 Stop the automatic icemaker.

- If the ICE MAKER OFF light (red) is off, press ICE MAKER OFF and check that the light comes on.

5 Wash the water tank (water pump, pipe, and purification filter), upper freezing case, and soundproofing mat with water. Allow them to dry completely, and then reinstall.

- To restart the automatic icemaker, press ICE MAKER OFF. (The ICE MAKER OFF lamp will go off.)



Page 7 Reinstall the water tank.

Note

- Do not use kitchen detergent, benzene, bleach, or other cleaning products to clean the purification filter. (Such products give ice odors.)
- For the other parts, be sure to read all of the instructions and observe the precautions when using cleaning products such as detergent and bleach.

- Be sure to assemble the water pump properly. Improper assembly may prevent ice from being made or increase the operation noise.

Icemaker does not produce ice or produces very little ice; water level in the water tank does not decrease







- 1 Has the refrigerator just been installed?
- 2 Are the water pump and pipe fitted securely to the water tank?
- 3 Have you left any food items or the ice server in the ice storage bin?
- 4 Is the automatic icemaker set to ICE STOP (red light is on)?

- 1 It sometimes takes 4-5 hours for the refrigerator to cool and 24 hours to make ice in the summer.
- 2 Be sure to check that the pipe outlet in the water tank is fitted securely to the tank. Page 10
- 3 The refrigerator has mistakenly determined the ice storage bin is full. Remove any food items or the ice server from the ice storage bin. In addition, level the ice in the bin.
- 4 Turn off the ICE STOP light (red.) Page 7

Troubleshooting

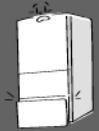
If the problem is not resolved after troubleshooting, immediately contact your refrigerator retailer.

Problem	Check the following	Solutions and reasons
Refrigerator does not cool	① Is the refrigerator receiving power?	① Check the power cord plug and the circuit breaker.
Refrigerator does not cool sufficiently; refrigerator produces little ice or ice melts 	① Is the temperature control knob set to MID or a left of MID? ② Has the refrigerator just been installed? ③ Is there sufficient space around the refrigerator? Is the refrigerator in direct sunlight or is heat ventilation hampered? ④ Have you blocked the flow of refrigerated air? Is the door opened frequently or left ajar?	① Adjust the temperature control knob to a cooler setting (towards COLDER). ② It sometimes takes 4-5 hours for the refrigerator to cool and 24 hours to make ice in the summer. ③ Check that the refrigerator is installed and set up correctly. Page 2 ④ Check that the refrigerator is not excessively packed with food items and that the doors are not ajar. Page 2
Items in compartments other than the freezer compartment begin to freeze 	① Is the temperature control knob for the refrigerator compartment set to COLDER? ② Have you placed items with high water content in the back of the refrigerator? ③ Is the ambient temperature less than 5 °C?	① Adjust the temperature control knob to a warmer setting (towards MID). ② Store beverages and food items that have high water content such as vegetables and fruit in the front of the refrigerator. ③ Set the temperature control knob to MID so food items will not freeze easily.
Condensation collects on the exterior of the refrigerator and frost collects in the freezer compartment 	① Is the door opened frequently or left ajar? ② Is it a rainy or highly humid time of the year?	① Condensation and frost can form if the doors are only slightly ajar and the moisture in the air cools. Page 2 ② Condensation may temporarily collect on the refrigerator. Wipe the refrigerator with a dry cloth. In addition, frost may form easily in the freezer compartment. Open and close the freezer compartment door only as much as necessary.
Doors are easy to open or difficult to close 	① Is any food item contacting a door? Is the refrigerator excessively packed with food items? ② Has any food item dropped behind the case in one of sliding doors or is the power cord pinched between the door and the refrigerator? ③ Is the refrigerator installed on an uneven surface? Are the adjusting supports contacting the floor?	① Do not store food items so that they stick out from the shelves or cases. ② Remove any dropped or pinched item. Be careful not to pinch items such as food items, the power cord, or plastics bags between the door and the refrigerator. ③ Lower the adjusting supports to raise the front of the refrigerator and make closing the doors easier. Page 2
Strong odors (food items or ice)	① Have you placed items with strong odors inside the refrigerator without wrapping them in plastic wrap? ② Is the water tank clean?	① The deodorizer cannot completely remove extremely strong odors. Be sure to wrap food items with strong odors in plastic wrap. ② Clean the water tank regularly.
Noise interference with television	① Is your television or other household appliance located near the refrigerator? ② Is the refrigerator power cord plugged into an electric outlet near the antenna outlet?	① Relocate the refrigerator or the household appliance. ② Use a dedicated outlet and ground the refrigerator.
Loud or disturbing noises The noises listed to the right are normal 	① The noise gets loud suddenly or the tone changes. ② Sometimes (every 1-2 hours), a whirring or rumbling sound is heard. ③ After the power is turned on and sometimes during ice making (every 1-2 hours), low-pitched and high-pitched sounds are heard. ④ Slight whistling sounds are heard when the doors are closed. ⑤ Sometimes hissing or bubbling sounds are heard. ⑥ Sometimes after opening a door, a cracking sound or the sound of dripping water is heard from within the refrigerator. ⑦ Sometimes a sound like buzzing mosquitoes is heard.	① The refrigerator switches to high-speed operation for powerful cooling after the unit has been first installed, it is hot, or the doors are opened and closed frequently. ② These are the sounds of ice making. Even if the water tank is empty, the automatic icemaker and water pump make a sound every 100 minutes. ③ These are sounds from the operation check of the ice making. The operation check is performed even if the automatic icemaker is set to ICE STOP. ④ These sounds are made when the fan motor starts. ⑤ These are the sounds of the flowing refrigerant (gas). ⑥ A creaking or cracking sound is made when warm air has entered the refrigerator, causing the plastic parts to expand. ⑦ This sound is made when the air control damper operates.
Exterior gets hot or wind blows from the bottom of the refrigerator		The refrigerator is equipped with piping to prevent condensation and for heat ventilation from the sides and above the unit. In addition, the refrigerator is equipped with a fan on the bottom of the unit to aid in heat ventilation. When the refrigerator is first used and during the summer, warm air can flow from under the refrigerator, especially when the exterior temperature is 50-60 °C. This is necessary for cooling and is not a malfunction.

Safety Precautions

■ Danger and the degree of danger caused by improper handling are categorized and described using the following symbols.

Warning

Improper handling can cause death, serious injury, etc.

Caution

Improper handling can cause injury or damage to the house, furnishings, etc.

■ Meaning of symbols

	Do not do
	Do not touch
	Do not attempt to disassemble, repair, or alter
	Do not get wet or dampen with water
	Do not touch with wet hands
	Be sure to follow the instructions as indicated
	Be sure to ground the refrigerator
	Be sure to remove the power cord plug from the outlet

■ In the case of a malfunction or defect, immediately turn off the refrigerator and contact your refrigerator retailer, the Mitsubishi Electric Maintenance Service, or a customer service representative.

Warning

Use a dedicated outlet for the power supply that meets the rating specified on the rating label. (The rating label is located on the door-liner of the refrigerator compartment.)

Using an extension cord or plugging in too many power cords into the outlet can cause heat buildup or a fire.



Page 2 Only use an outlet that meets the specified rating.

If the power cord is damaged.

If the power cord is damaged call Mitsubishi Electric Service Centre for a technician to replace power cord.

The power cord should be designed for this model.



Service Call

Page 2

- The appliance is not intended for use by young children or infirm persons without supervision
- Young children should be supervised to ensure that they do not play with the appliance



Do not place containers with water on top of the refrigerator.

Wet electrical parts can cause electric shock or a fire.

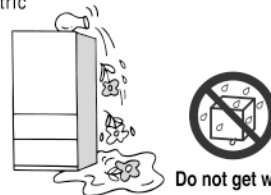

Do not get wet

Do not wash with water or spill food liquids on the refrigerator.

Water and food liquids can cause electric shock or a fire.



Do not get wet

Do not place objects on top of the refrigerator.

The objects may fall when the doors are opened and closed and cause injury.



Prohibited

Do not use flammable sprays near the refrigerator.

Sparks from electric contact can cause a fire.



Do not use

Do not hang on the door or door handle and do not stand on the sliding doors.

The refrigerator may tip over and cause injury.



Prohibited

Do not store medicine or scientific specimens in the refrigerator.

Items that require strict management cannot be stored in household refrigerators.



Do not store

Do not place volatile flammable items inside the refrigerator.

Benzene, cosmetics, and hair products can catch fire and explode.



Do not store

Do not touch the machinery of the automatic icemaker (located above the ice storage bin).

The rotating ice tray can cause injury.



Do not touch

Caution

In case of a malfunction (burning odor is detected, etc.), remove the power cord plug from the outlet and turn off the refrigerator.

Continued operation of the refrigerator with a malfunction can cause electric shock or a fire.



Remove the plug

Remove the power cord plug from the outlet before maintenance or changing the interior light bulb.

Failure to do so can cause electric shock or injury.



Remove the plug

Do not press the back of the refrigerator against the power cord plug.

Do not damage the power cord.

Pressing against, placing weight on, folding, or bundling the power cord can cause electric shock or a fire.



Prohibited

Use only interior light bulbs with the specified rating.

Using non-specified light bulbs can cause a fire.



Specified products only

Page 9

Do not use damaged power cords or plugs, or loose outlets.

Doing so can cause electric shock or a fire.



Do not use

Remove any dust from the power cord plug.

Insulation failure can cause a fire.



Remove dust

Do not pull on the power cord to remove the plug.

Doing so can damage the power cord and cause electric shock or a fire.



Prohibited

If you notice a gas leak, do not touch the refrigerator. Open the windows to ventilate.

Sparks from electric contact can cause an explosion or a fire.



Ventilate

Do not remove or insert the power cord plug with wet hands.

Doing so can cause electric shock.



No wet hands

Before disposing of the refrigerator, be sure to pull the seal off of the doors.

Children can be put in danger if they are trapped inside the refrigerator.



Remove the seal

Do not dismantle, repair, or alter.

Doing so can cause injury, electric shock, or a fire.



Do not disassemble

Use the adjusting supports so the refrigerator is securely installed on a strong level surface.

If the refrigerator is not installed properly, it could move and cause injury.

Page 2

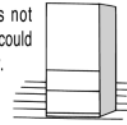

Install level

Use the transportation handholds when transporting the refrigerator.

Holding other parts can cause injury.

Page 9



Hold the handholds

Do not overfill the refrigerator with food or remove the shelves with excessive force.

Doing so can cause food items to fall and cause injury.



Prohibited

Do not place glass bottles in the freezer compartment.

The contents of the bottle can freeze and cause the bottle to break and cause injury.

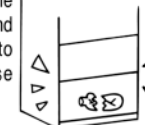

Do not store

Do not eat food that has a unfamiliar odour or is altered colour and smell.

Doing so can cause food poisoning or illness.



Prohibited

Do not touch food items or containers in the freezer compartment with wet hands.

Doing so can cause frostbite.



No wet hands

Do not put your hands or feet underneath the refrigerator.

The metal plates, etc., on the bottom of the refrigerator can cause injury.



Do not touch

Do not push the door shut.

Use the door handle to close the door.

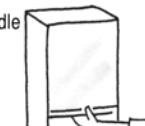

Hold the door handle

Accessories

	Model name	MR-CU415X	MR-CU375X
	Accessories	Quantity	Quantity
Refrigerator compartment	Adjustable shelf	2	1
	three-way flexishelf	1	1
	Sliding case (upper)	1	1
	Sliding case (lower)	1	1
	Water tank (including purification filter)	1	1
	Free pocket (L)	1	2
	Free pocket (S)	1	-
	Free egg tray	1	1
	Small-item pocket	1	-
	Bottle pocket	1	1
Vegetable compartment	Vegetable case	1	1
	Sliding case	1	1
Freezer compartment	Freezing case (upper)	1	1
	Freezing case (lower)	1	1
	Soundproofing mat	1	1
	Ice server	1	1
	Drain pan	1	1
	Toe grille	1	1

■ This appliance is designed for use in Australia and New Zealand only and cannot be used in any other country. No service is available outside of Australia and New Zealand."

When you hear noise from the lower rear of the refrigerator

- As part of the cooling system is a compressor that, when it operates, does make a more noticeable increase in noise level. This is normal. However, if the noise is quite loud, this could be because the refrigerator is not installed correctly on a hard level surface, or there may be a problem that may need service.

CAUTION

1. This appliance is designed for use in ambient temperature listed below.

MODEL NAME	AMBIENT TEMPERATURE RANGE	CLIMATIC CLASS
MR-CU375X, CU415X-A	16 °C ~ 43 °C	T
MR-CU375X, CU415X-NZ	16 °C ~ 43 °C	T

The internal temperatures could be affected by such factors as the location of the refrigerating appliance, ambient temperature and the frequency of door opening, and, if appropriate, a warning that the setting of any temperature control device might have to be varied to allow for these factors.

2. A rise in temperature of the frozen food during manual defrosting, maintenance or cleaning could shorten the storage life.
3. Food to be frozen is not to be placed in direct contact with food in storage and, if appropriate, that it could be necessary to reduce the quantity to be frozen if freezing every day is anticipated.
4. The electrical power failure for 1-2 hour will only slightly effect the inside temperature. However, open & close of the door results in the temperature loss. In case there is more than 24 hour electrical power failure, the food should be taken out from the fridge.
5. In case you are leaving or there is no food in the fridge for more than 3 weeks, The fridge should be unplugged and cleaned.

Intelligent Fuzzy Logic Control

The smart microprocessor control system incorporated in this refrigerator constantly monitors and analyzes the temperature and usage. This data is used to automatically optimise the refrigerators performance.

This is a summary of these special modes

- *Pre-cool operation: Before the defrosting starts and if the door is frequently opened the refrigerator will automatically rapidly cool the food to ensure it does not spoil during defrost.
- *Defrost timing selection: The microprocessor learns the time of day when the door is less likely to be opened. This time is then used for defrost allowing more efficient defrosting and the food temperature to remain more constant.
- *Automatic quick freezing: The microprocessor quickly identifies when warm food is put in the freezer compartment and automatically enters a more powerful cooling cycle.
- *Energy saving mode: This is a special mode that allows extra energy conservation. To enter this mode the freezer must be set to the warmer settings, the icemaker must be turned off and the door not opened for extended periods of time. In this mode the food temperature will fluctuate but the average food temperature will keep the food safe.

Note: The refrigerators will not enter this mode if the auto-icemaker is turned on or the door is opened frequently.

MEMO



MEMO



MITSUBISHI ELECTRIC CORPORATION

HEAD OFFICE : TOKYO BUILDING 2-7-3, MARUNOUCHI, CHIYODA-KU, TOKYO 100-8310, JAPAN
 PHONE: +81 (3) 3218-2111
<http://Global.MitsubishiElectric.com>

Distributed by:

MITSUBISHI ELECTRIC AUSTRALIA PTY LTD.

(Incorporated in New South Wales) ABN 58 001 215 792

New South Wales:

348 Victoria Road, Rydalmere 2116 Ph: (02) 9684 7777, Fax: (02) 9898 0484

Queensland:

Unit 12, 469 Nudgee Road, Hendra QLD 4011 Ph: (07) 3623 2000, Fax: (07) 3630 1888

South Australia / Northern Territory:

77 Ports Road, Hindmarsh 5007 Ph: (08) 8340 2000, Fax: (08) 8340 0555

Western Australia:

Unit 5, 329 Collier Road, Bassendean 6054 Ph: (08) 9377 3400, Fax: (08) 9377 3499

Victoria / Tasmania:

Suite 28, 270 Ferntree Gully Road, Notting Hill VIC 3168 Ph: (03) 9535 7800, Fax: (03) 9535 7801

Distributed by:

BLACK DIAMOND TECHNOLOGIES LIMITED (BDT)

Wellington Office (Head Office)



1 Parliament Street PO Box 30-772 Lower Hutt Ph: (04) 560 9100, Fax: (04) 560 9133

Auckland Office

Unit 1, 4 Walls Road Penrose Auckland PO Box 12-726 Ph: (09) 526 9340, Fax: (09) 526 9369

Christchurch Office

Suite 2, Level 1, 37 Manderville Street Christchurch PO Box 1604 Ph: (03) 341 7052, Fax: (03) 341 7054

 With low energy Protect the environment Live well	<h3>Power saving</h3> <p>Refrigerators use the most electricity of all household appliances. Even a little effort can help to save electricity. Let's all try to save power.</p>	<p>Are you putting hot items directly into the refrigerator without allowing them to cool first?</p>	<p>Are you opening the doors more often than necessary?</p>	<p>Is the refrigerator cooling too much?</p>
<h3>Tender care inspection</h3> <p>● Inspect the refrigerator to get many years of use!</p>				
	<p>Have you noticed these symptoms?</p>	<ul style="list-style-type: none"> ● The power cord or plug is unusually hot. ● The power cord has a deep cut or is deformed. ● You smell something burning. ● Water is always collecting on the floor under the refrigerator. ● You get shocked when you touch the refrigerator. ● You notice any other abnormality or malfunction. 	<p>Stopping use</p>	<p>To prevent an accident or when there is a malfunction, remove the power cord plug from the outlet and be sure to contact your refrigerator retailer for inspections or repairs.</p>
<p>Customer memo Convenient information when requesting repairs or service</p>	<p>Purchase date</p> <p>Year Month Day</p>	<p>Retailer</p> <p>Telephone number ()</p>		