

mitsubishi
Refrigerator-Freezers



OPERATING INSTRUCTIONS

SERIES MODEL MR-508U, MR-560U
MR-508UL, MR-560UL

1. Names of the parts

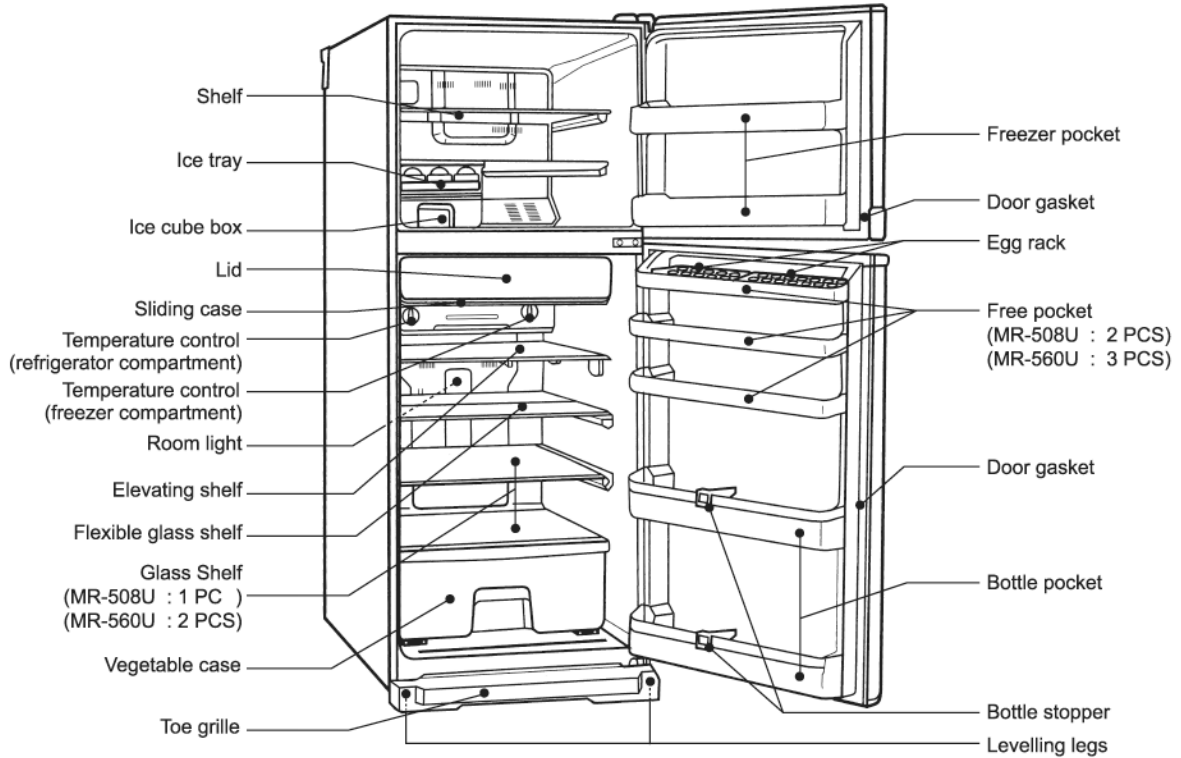

This picture shows Series Model MR-508U, MR-560U

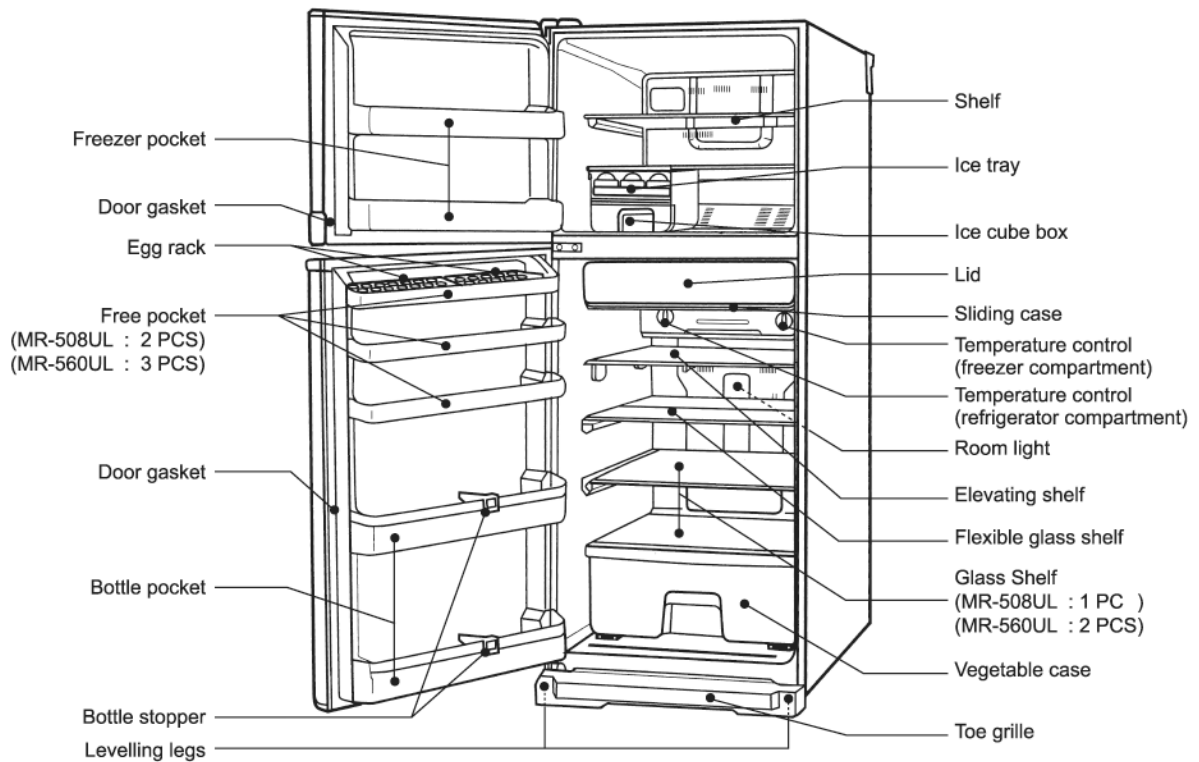

This picture shows Series Model MR-508UL, MR-560UL

2. Installation

- Install on a completely flat and rigid surface.
- Using the two front Adjustable feet, ensure that the refrigerator is positioned firmly and level on the floor. Now open the door approximately half way, and extend the front adjustable feet equally until the door closes by itself.

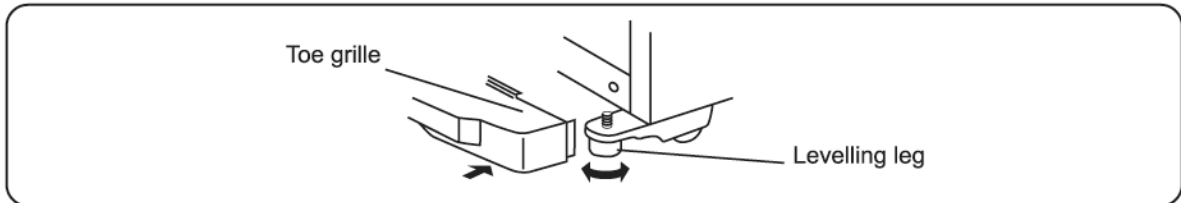

- To ensure adequate ventilation for your refrigerator, it is recommended to provide space of 20 mm on both sides, 50mm at the back, and space of 100 mm above the refrigerator. Insufficient spacing will decrease the cooling efficiency, resulting in unnecessary consumption of electricity.
- Choose a location which is not exposed to the sun, which is relatively free from dust, heat and humidity, and which offers good ventilation. This is to guarantee that the heat radiation will not be impaired.

When transporting

- Before transporting, wipe dry the drain pan on the bottom, behind the toe grille. Carry the refrigerator by holding the handles located on the rear and bottom.

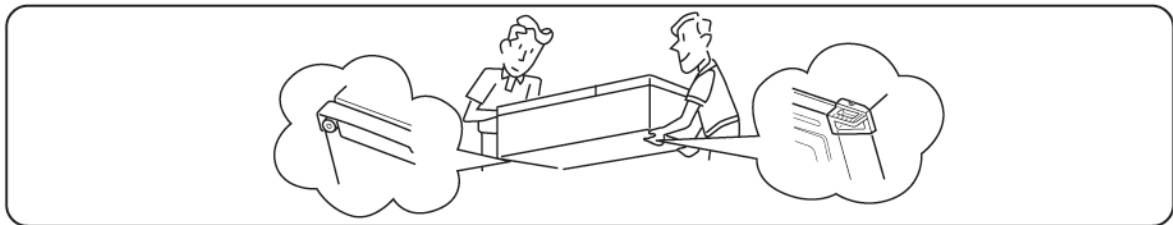

3. Electrical connection

Important: For personal safety, this appliance must be properly grounded.

- The refrigerator should always be plugged into its own individual electrical outlet. This is recommended for best performance and also to prevent overloading of the house wiring circuits, which may cause a fire hazard. Extension cords are not recommended. Be sure that the proper voltage is provided from the outlet.
- If your refrigerator has a grounding plug, use it correctly. The 3-point plug must be inserted into a mating 3-point grounded receptacle. If the installation does not have a proper 3-point grounding wall receptacle, it must be changed to the proper type. The ground point should never be cut or removed.

4. Operation

1. Temperature control

- Both the freezer compartment and the refrigerator compartment have a temperature control.
- "MID" is recommended for normal usage.
Turn the dial to "COLDER" when keeping lots of frozen foods, ice cream, etc., in the freezer compartment
Turn the dial to "FREEZER" when using the freezer compartment only for making ice.

Temperature control of freezer compartment

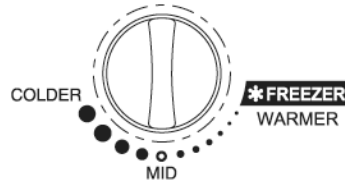

- "MID" is recommended for normal usage.
Turn the dial to "COLDER" if you want items to be colder in the refrigerator compartment.
Turn the dial to "REFRIGERATOR" if your item are too cold or freeze in the refrigerator compartment.

Temperature control of refrigerator compartment

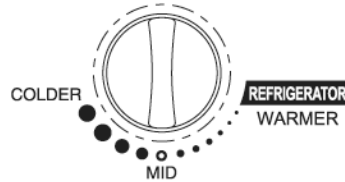

2. Automatic defrosting

- The defrosting heater provides automatic defrosting in the refrigerator according to accumulated time by the microcomputer. There is, therefore, no need to defrost it. Water produced during defrosting passes through the drainage house at the rear and collects in the drain pan at the bottom of refrigerator. Then, it automatically evaporates with the heat from the refrigerator pipe utilized as a radiator.

3. Ice making

- Pour water into each of the sections of the ice tray up to the water line. Insert the tray completely into the ice tray holder. (The ice cubes will not separate easily from the ice tray if you add too much water.)
- Once the ice cubes are made, turn the lever until the ice cubes fall into the ice cube storage box. The ice cube storage box will break if you attempt to make ice directly in the ice cube storage box.



4. Sliding case

- This sliding case is cooled down to a low temperature to preserve freshness of foods stored for a long time.

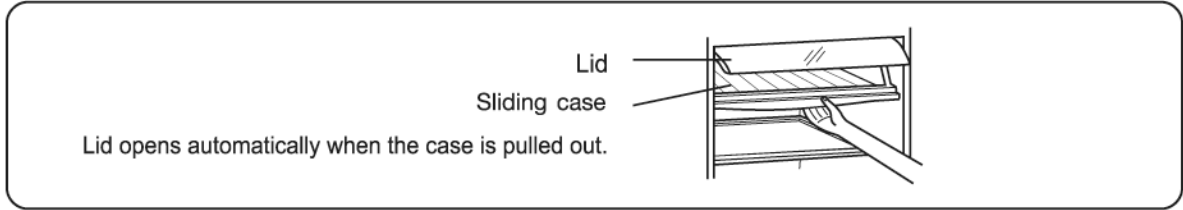

CAUTION :

Before closing the refrigerator compartment door, make sure that the sliding case is pushed in all the way (the lid is closed correctly).

- Remove the lid and sliding case as in the figure and proceed with cleaning.
- Come off by pulling out the case, open the lid, then pull out while holding the light-hand side with the lid moved towards the left-hand side. (Fig.1)
- Come off by pulling the case out all the way, then pulling out while holding and lifting the edge of the case upwards. (Fig.2)

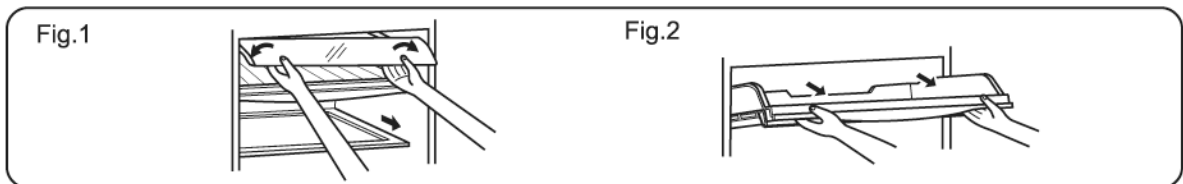

5. Door racks

The door racks can be used to store all those little things that seem to get in the way. if you put small items in one place, you will find that there is more room inside the refrigerator for the larger things.

Free pocket with egg tray

- The free pocket can hold many eggs. (Fig. 1)
- If you turn half the eggs tray over, you will be able to store small items along with eggs. (Fig.2)
- You can even turn the whole egg tray over and store small items in the free pocket instead of eggs. (Fig.3)

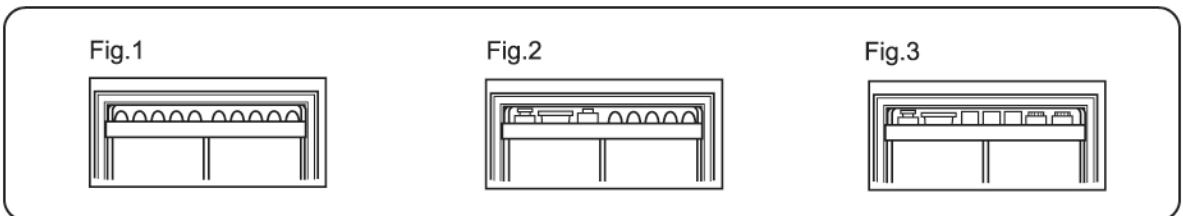

Bottle pocket

- Even large sized bottles can stored in this pocket

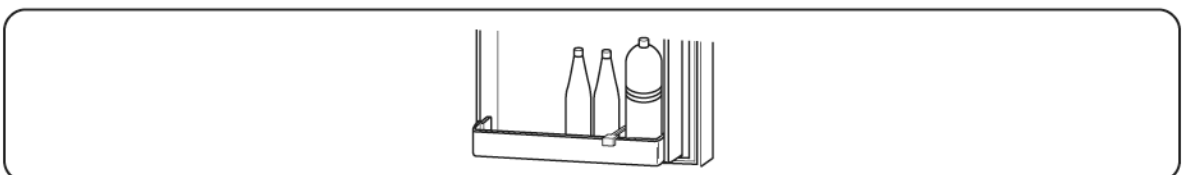

Depending on the type, commercially sold water cooler bottles may touch the shelf or foodstuffs when placed in the door pocket, preventing the door from closing firmly.

FREEZER POCKET

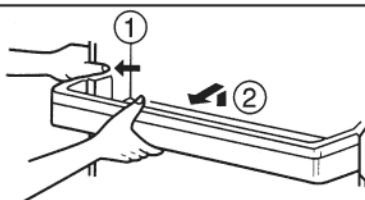

FREE POCKET

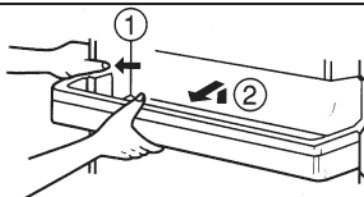

BOTTLE POCKET

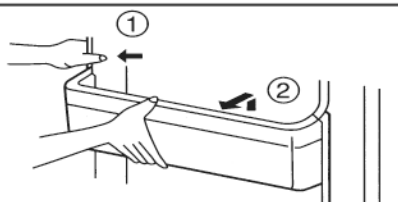

6. Flexible glass shelf

- The flexible glass shelf can be folded up inside to accommodate large items or tall items. Pull up the front of the flexible glass shelf a little, and then push the shelf in. The shelf can be folded up to half its former width and small items can be stored on it.

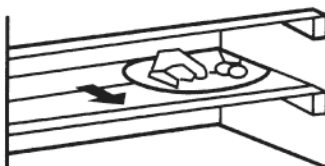

- Lift up the front part of the shelf and then push it back to the rear. this creates a storage space which is equivalent to the removal of the shelf.

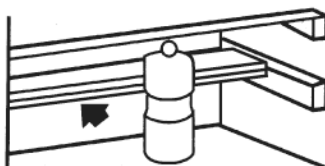

7. Elevating shelf

- Move the lever on the front of the shelf left or right to adjust the shelf to the desired position.

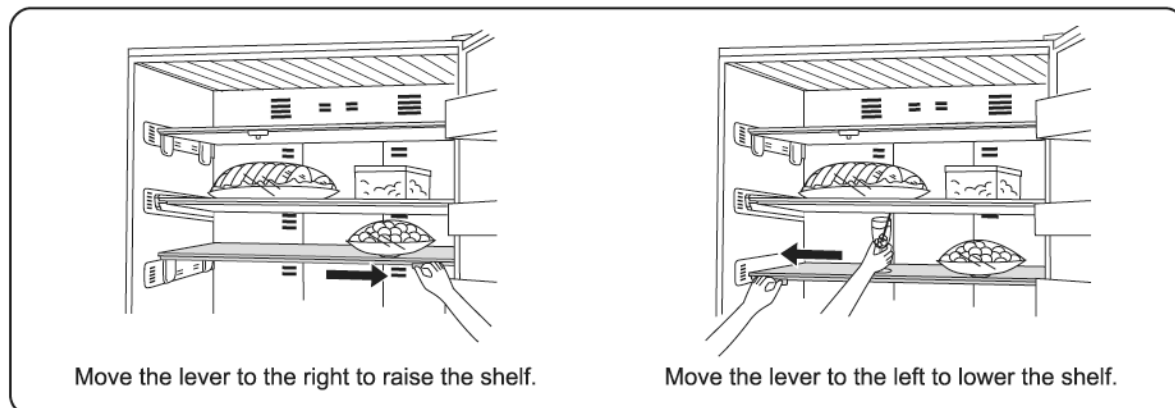

- The lever will be difficult to move when heavy items are placed on the shelf.
- When the elevating shelf is lowered, one of the shelf supports may come off if the shelf contacts any foods under the shelf. This is to prevent damaging the foods. If one of the supports comes off, push it back into position from above.

Installation

- ① Make sure that the lever is moved completely to the right.



- ② Make sure that the 4 metal stoppers are securely fitted into the refrigerator, then lightly set the shelf into the refrigerator and align the 4 supports with the 4 stoppers.

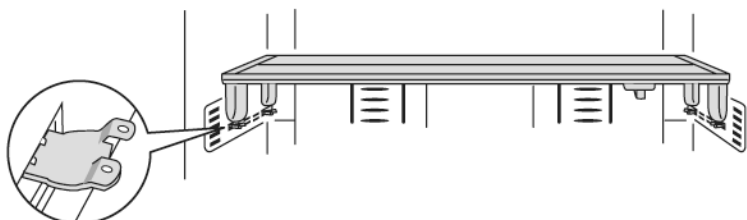

- ③ Push each of the 4 supports, one at a time, downward from above. (When the internal hooks catch onto the refrigerator, a "click" sound will be heard.)

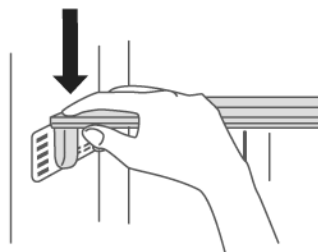

- ④ Finally, move the lever to the left and right and check that the shelf moves up and down while remaining level. (If the shelf does not remain level, the 4 hooks are not securely caught onto the refrigerator. Remove the shelf and repeat steps 1 to 4.)

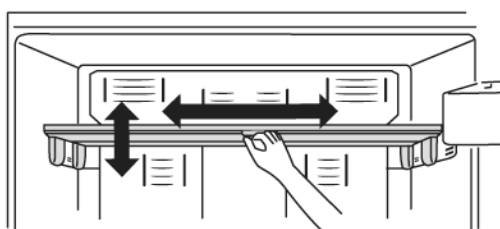

5. Maintenance

When performing maintenance, make absolutely sure that the power plug is disconnected from power outlet.

- Dip a soft cloth or lukewarm water, wring it out well and wipe.
- If you do not clean the door gasket(especially the lower part) when it is dirty, the gasket will easily be damaged. Therefore,keep it clean at all times.
- Do not clean with cleanser, benzine, thinner, boiling water, soap powder, chemical cloths or neutral detergents. These will damage the paint finish and material of your refrigerator.

CAUTION

Do not apply water directly to the refrigerator.

This may result in a breakdown, power leakage or fire.

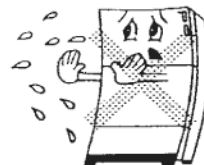

1. How to remove drain pan

- Hold the toe grille of both the right hand side and left hand side , then press it and gradually pull it out.
- Gradually pull out the drain pan by using right and left hand.

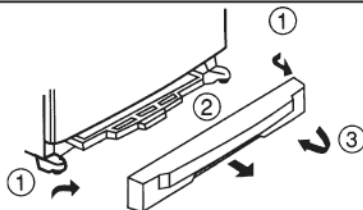

2. How to replace the room light

Important : Unplug the power cord. Failure to unplug the power cord may cause an electric shock.

- Push the cover (down or upper side of room light cover, pull the cover forward and then remove the cover.
- Use the light 240V/15W (capE-12) ,which can purchase at distributor shop or MITSUBISHI company.

Refrigerator

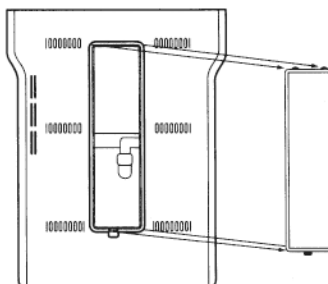

3. How to remove the elevating shelf

- ① Move the lever completely to the right.

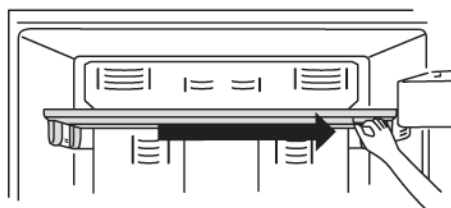

- ② Push up each support, one at a time, with a strong effort. (4 supports) (When the internal hooks are released from the refrigerator, a "click" sound will be heard.)

If the supports are not released easily, push the internal hooks inward.

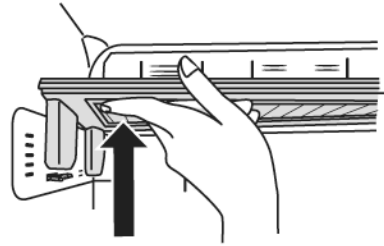
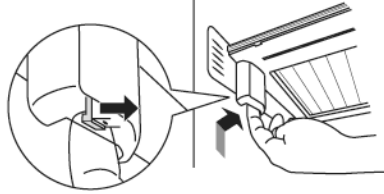

- ③ After the 4 supports are released, pull out the shelf.

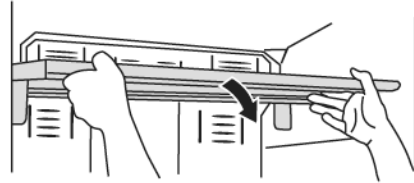

4. How to remove the tray

- ① Push the tray upward while pulling forward the hooks (3) at the back of the shelf with your finger.

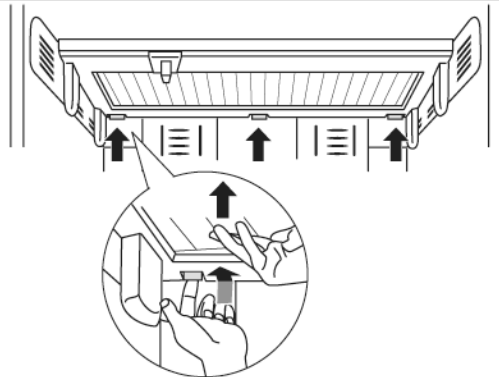

- ② Lift up the back of the tray until the front hooks (4) are released.

* Lift up the tray slowly, otherwise it may fall.

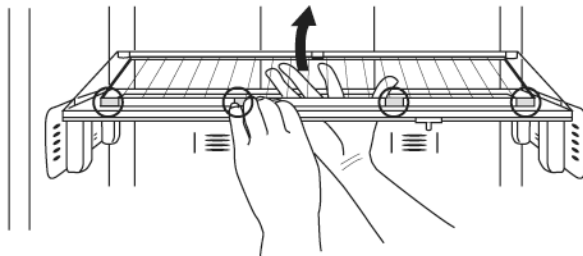

- ③ Remove the tray with both hands.

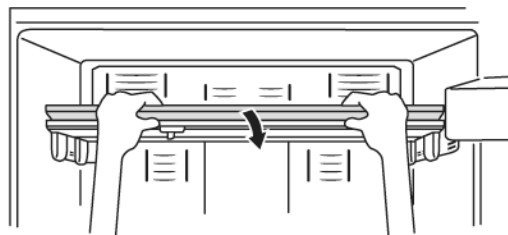

● Disassembling or applying grease to the elevating shelf can cause it to malfunction.

6. Suggestions for safety

The suggestions below apply to the operation of your home electric refrigerator.

Mitsubishi Electric Corporation recommends these safety precautions.

- If your old refrigerator is still around the house but not in use, be sure to remove the door(s). This will ensure that children will not get trapped inside.
- Never unplug your refrigerator by pulling on the wire. Always take hold of the plug firmly and pull it straight out of the receptacle.
- Do not operate your refrigerator in the presence of explosive fumes.
- Fizzy drinks should not be frozen.
- Avoid immediate consumption of ice lollies and other similar frozen food items.
- If the power cord is damaged, call our Mitsubishi Service Centre to arrange for it to be replaced in order to avoid a hazard.
- Keep ventilation openings, in the appliance enclosure or in the built in structure, clear of obstructions.
- Do not use mechanical devices or other means to accelerate the defrosting process.
- Do not use electrical appliance inside the food storage compartments of the appliance. unless they are the type recommended by the manufacturer.
- This appliance is not intended for use by young children or infirm person unless they have been adequately supervised by a responsible person to ensure that they can use the appliance safely.
- Young children should be supervised to ensure that they do not play with the appliance.
- This refrigerator uses flammable foaming gas for insulation.
- Please deliver the unit to specialized industrial waste dealer when you wish to dispose of it.
- When disposing refrigerators please dispose following the rules in your country, refrigerators contain refrigerant that requires recovery by qualified / licensed personnel before disposal.

7. Troubleshooting

When the refrigerator does not operate

- Check if there is a power failure.
- Check if the power cord is plugged into the power outlet.
- Check that the fuse (or circuit-breaker) has not blown.

When the refrigerator is cooling excessively

- The temperature control dial may be set too high.
- If you place foodstuffs containing a lot of moisture directly under the cool air outlets, they will freeze easily. This does not indicate a malfunction.

When you hear a sound like water flowing

- A sound like water flowing is the refrigerant (cooling gas) flowing. It does not indicate a malfunction.

When the refrigerator is not cooling sufficiently

- The food may be packed too tightly together which will block the flow of cool air.
- You may have put something hot or a lot of foodstuffs into the refrigerator.
- The door may not have been closed properly.
- The door gasket may be damaged.
- The refrigerator may not be well ventilated.
- There may be insufficient clearance between the refrigerator and the surfaces immediately beside and above.
- The temperature control dial may not be set properly.

When condensation forms on the outside of the refrigerator

- Condensation may form on the outside when the humidity is high, such as during a wet season. This is the same result as the condensation formed when chilled water is poured into a glass. It does not, therefore, indicate a failure. Wipe dry with a dry cloth.

When the power plug is disconnected and connected again, and the compressor ceases to rotate

- When the power plug is disconnected from the power outlet and then immediately plugged in again, the compressor may not start up again. Therefore, when unplugging the power plug, always wait at least 5 minutes before plugging it in again. (If the compressor ceases to rotate completely, keep the power plug unplugged and wait at least 5 minutes before plugging it in again.)

When the refrigerator's cabinet front heats up

- In order to safeguard against condensation, there is an anticondensation pipe which heats up the cabinet front when actuated. A warm cabinet front does not indicate a malfunction. (The more the door is opened and closed, the more the anti-condensation pipe is actuated. It is also actuated immediately after the refrigerator has been installed. In other words, the cabinet front often heats up.)

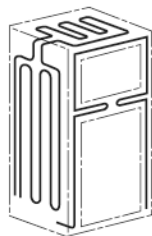

**MR-508U , MR-560U
MR-508UL, MR-560UL**

When the cabinet's side panel heats up

- The side panel of the cabinet will heat up when the door is opened and closed frequently, when installing the unit and when the unit operates in summer with high outside temperatures. In such cases, do not touch the panel. This heat buildup is due to the dissipation of the heat absorbed from inside the cabinet over the whole of the cabinet's side panel and it does not mean that something is wrong with the unit.

When you hear a noise from the refrigerator's fan grill

- As part of the cooling operation a fan runs at times causing a small increase of noise. This is normal.

When you hear some noise occurring when the refrigerator's door is open

- When the room temperature is very warm and the refrigerator's door is open, the change in temperature may cause some creaking noise as the plastic parts expand. This is normal.

When you hear a noise from the lower rear of the refrigerator

- As part of the cooling system is a compressor that, when it operates, does make a more noticeable increase in noise level. This is normal. However, if the noise is quite loud, this could be because the refrigerator is not installed correctly on a hard level surface, or there may be a problem that may need service.

CAUTION

1. A rise in temperature of the frozen food during manual defrosting, maintenance or cleaning could shorten the storage life.
2. Food to be frozen is not to be placed in direct contact with food in storage and, if appropriate, that it could be necessary to reduce the quantity to be frozen if freezing every day is anticipated.
3. The electrical power failure for 1-2 hour will only slightly effect the inside temperature. However, open & close of the door results in the temperature loss. In case there is more than 24 hour electrical power failure, the food should be taken out from the fridge.
4. In case you are leaving or there is no food in the fridge for more than 3 weeks, The fridge should be unplugged and cleaned.



MITSUBISHI ELECTRIC CORPORATION

HEAD OFFICE : TOKYO BUILDING 2-7-3, MARUNOUCHI, CHIYODA-KU, TOKYO 100-8310, JAPAN

PHONE: +81 (3) 3218-2111

<http://Global.MitsubishiElectric.com>

Distributed by:

MITSUBISHI ELECTRIC AUSTRALIA PTY LTD.

(Incorporated in New South Wales) ABN 58 001 215 792

New South Wales:

348 Victoria Road, Rydalmere NSW 2116 Ph: (02) 9684 7777, Fax: (02) 9898 0484

Queensland:

Unit 12, 469 Nudgee Road. Hendra QLD 4011 Ph: (07) 3623 2000, Fax: (07) 3630 1888

South Australia / Northern Territory:

77 Ports Road, Hindmarsh SA 5007 Ph: (08) 8340 2000, Fax: (08) 8340 0555

Western Australia:

Unit 5, 329 Collier Road, Bassendean WA 6054 Ph: (08) 9377 3400, Fax: (08) 9377 3499

Victoria / Tasmania:

Suite 28, 270 Ferntree Gully Road, Notting Hill VIC 3168 Ph: (03) 9535 7800, Fax: (03) 9535 7801

Distributed by:

BLACK DIAMOND TECHNOLOGIES LIMITED (BDT)

Wellington Office (Head Office)

1 Parliament Street PO Box 30-772 Lower Hutt Ph: (04) 560 9100, Fax: (04) 560 9133

Auckland Office

Unit 1, 4 Walls Road Penrose Auckland PO Box 12-726 Ph: (09) 526 9340, Fax: (09) 526 9369

Christchurch Office

Suite 2, Level 1, 37 Manderville Street Christchurch PO Box 1604 Ph: (03) 341 7052, Fax: (03) 341 7054