

Refrigerator-Freezer

OPERATING INSTRUCTIONS

SERIES MODEL

MR-CX328ER

MR-CX363ER



Cleaning Instruction - Important!

It is strongly recommended to use only lukewarm water and a soft cloth when cleaning. Cleaning agents can cause cracking to the plastic components of your refrigerator.

Contents

		Page
Before use	For your safety, please be sure to follow these instructions	2 - 3
	From installing to running your refrigerator	4 - 5
Operation	Using each compartment Refrigerator / Sliding case / Vegetable and Freezer Compartments	6 - 7
	How to adjust the temperature	8
	Automatic Ice-Maker	9 - 10
Cleaning	How to remove and clean accessories	11 - 12
	How to maintain your automatic ice-maker	13
When in trouble	What to do in these situations	14 - 15
	Troubleshooting	15 - 17
	Accessories	18
	MEMO	19



Fire/Flammable refrigerant

R600a Refrigerant Warning



- This appliance contains a small quantity of R600a refrigerant which is flammable.
- During transportation and installation, ensure that the tubing of the refrigerant circuit is not damaged.
- Leaking refrigerant can ignite and may damage the eyes.
- In the event any damage does occur, avoid exposure to open fires and any device which creates a spark. Disconnect the appliance from the mains power. Thoroughly ventilate the room in which the appliance is located for several minutes.
- The room for installing the appliance must be at least 1 cubic metre per 8 grams of refrigerant.
- The refrigerant quantity contained in this appliance is noted on the Rating Label of the appliance.







- Maintenance work shall only be carried out at workshop by well-trained maintenance worker.
- Please read this manual carefully and follow the information contained within. In particular, be sure to read the safety precautions before using this refrigerator.
- Be sure to receive your copy of the warranty from the retailer and confirm that the purchase date and retailer name are written on the warranty.
- Store this operating instructions manual and the warranty in a safe place.
- This refrigerator was manufactured for refrigerating and freezing of foods in general households. For commercial use, please use a commercial refrigerator-freezer.
- The photographs and illustrations contained in this manual are for the MR-CX363ER. While the capacity and dimensions of the MR-CX363ER are different from the MR-CX328ER, the operation is the same.
- The principal plastic components indicate the material name to facilitate recycling.
- Do not store explosive substances such as aerosol cans with a flammable propellant in this appliance.
- This appliance is intended to be used in household application only.
- **WARNING** - When positioning the appliance, ensure the supply cord is not trapped or damaged.
- **WARNING** - Do not locate multiple portable socket-outlets or portable power supplies at the rear of the appliance.
- **WARNING** - Just in case of having damaged the refrigerant circuit, do not use electric items or fire equipments near by, and open the window to ventilate the room. And contact the retail store at which you purchased it or the following MITSUBISHI SERVICE CENTRE.
- **WARNING** - Do not use mechanical devices or other means to accelerate the defrosting process, other than those recommended by the manufacturer.
- **WARNING** - Keep ventilation openings, in the appliance enclosure or in the built-in structure, clear of obstruction.
- The user manual should be handed over to any person who would use or handle the refrigerator whenever the refrigerator would be transferred to another location and delivered to a recycling plant.
- This refrigerator uses flammable foaming gas for insulation. Please deliver the unit to specialized industrial waste dealer when you do away it. Please follow the rules in your country.

For your safety, please be sure to follow these instructions

The types of danger that can result from improper handling are explained in the sections below.

■ The symbols illustrated below have the following meanings.

 WARNING	Mishandling can lead to serious injury or death.
 CAUTION	Mishandling can lead to bodily injury or loss of home and household contents.

	Do not do		Always follow instructions
	Do not get wet		Always connect an earth wire
	CAUTION		Always unplug electrical plug from socket

WARNING

When installing your unit



Do not install in an outdoor area where water can get on it or where there is a lot of moisture.

Due to insulation failure, it may cause an electric shock or fire. ➔ Page 4

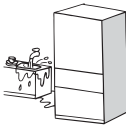

Allow some space around the refrigerator.

If the refrigerant (gas) leaks, it can remain in the area and there's a risk that it may cause a fire or explosion. ➔ Page 4

To be prepared for an earthquake, affix to a strong wall or column.

Not doing so may cause injuries from the refrigerator toppling over. ➔ Page 5



Attach ground wire and earth leakage breakers when use in a humid place and moist place.

(Please consult with the shop). ➔ Page 4

It may cause electric shock when electric leakage. And the following ground connection may cause electric shock, explosion and fire.

- Water pipe/gas pipe.
- Telephone ground lines and lightning rod.

About the electrical outlet and electrical plug



Do not push the electrical plug with the back of the refrigerator.

Do not damage the electrical cord.

If the plug is pressed by the refrigerator, or if the cord is bent, bundled, or a heavy object is placed on it, it can cause an electric shock or a fire.



Do not use damaged cords or plugs or loose outlets.

Using them can result in an electric shock or injury.

Do not remove the electrical plug by pulling the cord.

The cord can become damaged and can cause an electric shock or a fire.

Do not plug or unplug the electrical plug with wet hands.

It can cause an electric shock.



Use a dedicated outlet for the power supply that meets the rating specified on the rating label. (The rating label is located on the door-liner of the refrigerator compartment.)

Using an extension cord or plugging in too many power cords into the outlet can cause heat buildup or a fire. ➔ Page 4

Keep the electrical plug cord facing downwards and insert the plug in fully.

If it is plugged with the cord facing upward, extra pressure gets exerted on it which can cause it to heat up or ignite.



If the power cord is damaged.

If the power cord is damaged call Mitsubishi Electric Service Centre for a technician to replace power cord. The power cord should be designed for this model.

About the electrical outlet and electrical plug



Remove dust from the electrical plug.

Not doing so can cause a fire from insulation failure.



When replacing the interior refrigerator light or when taking care of the unit, pull out the electrical plug.

Not doing so can result in an electric shock or injury.

About using your refrigerator



Do not damage the refrigerant circuit (piping) of the refrigerator; do not drive in screws.

Because a flammable refrigerant (gas) is used, there is the danger of igniting or explosion.

Do not use electrical products inside the refrigerator unit.

If the refrigerant (gas) is leaking inside the unit, there is a risk that a spark from the electrical product's contact can be a source for ignition or explosion.

Do not store volatile products that can easily ignite.

Benzene, cosmetics and hair styling products can be the cause for igniting fires and explosion.

Do not store pharmaceuticals or scientific test material.

Anything that needs strict supervision must not be stored in a home-use refrigerator.

Do not place items on top of the refrigerator.

Items may drop from opening and closing the door and can cause injury.

Do not hang on the door or door handle, and do not get on compartment drawer-type doors.

The refrigerator can topple over causing injury.

Do not add a strong impact on the glass shelf.

The glass will break and it may cause injury.

Do not put your hands in the mechanical part of the automatic ice-maker (the upper part of the ice storage box).

Doing so will cause injury.

Do not use flammable sprays nearby.

A spark from the electrical contact can ignite and cause a fire.



- Water to use for your automatic ice-maker
WARNING: fill with potable water only. ➔ Page 9
- This appliance is not intended for use by young children or infirm persons unless they have been adequately supervised by a responsible person to ensure that they can use the appliance safely.
- Young children should be supervised to ensure that they do not play with the appliance.
- This appliance is not intended for use by persons (including children) with reduced physical, sensory or mental capabilities, or lack of experience and knowledge, unless they have been given supervision or instruction concerning use of the appliance by a person responsible for their safety. Children should be supervised to ensure that they do not play with the appliance.



When something abnormal or unusual occurs, turn off immediately and consult with “the store where you purchased the unit” or with a “Mitsubishi Electric repair centre.”

⚠️ WARNING

About using your refrigerator



Do not do

Do not use in a shed or a garage.

If small animals damage the wiring, it can cause an electric shock or a fire.

Do not encapsulate refrigerant other than already specified.

It may cause rupture, explosion, fire, etc. when using, repairing, disposal, etc.



Do not get wet

Do not put any vessels, jars, etc. that contain water on top of the refrigerator.

If water gets onto electrical parts, it will cause an electric shock or a fire.

Do not wash with water or spill liquid food items on the unit.

If water and food liquids get on the unit, it can cause an electric shock or a fire. If that happens, dry off immediately.



Always follow instructions

If you sense a gas leakage, do not touch the refrigerator. Open the window and ventilate the room.

A spark from the electrical contact can cause an explosion or a fire.

When the doors are opened or closed, beware not to hit any furniture.

The door or furniture may be damaged and cause any injury.

About Malfunctions / Long Term Care



Do not do

Do not take apart, repair or convert. Do not continue to use with damaged parts.

This can cause injury, an electric shock or a fire.



Always follow instructions

If the refrigerant circuit (piping) is damaged, do not touch the refrigerator, open the window and ventilate the room.

When the refrigerant circuit is damaged, please consult the store in which the unit was purchased.

If you will not be using the refrigerator for a long period of time, after pulling out the electrical plug, open the door and let the interior dry out.

If it is not dried adequately, the cooling unit may corrode causing the refrigerant (gas) to leak which can then cause the danger of ignition or explosion.



Always unplug electrical plug from socket

If something abnormal occurs (such as a burning smell), pull out the electrical plug and stop the refrigerator from running.

If it continues to run in an abnormal state, it can cause an electrical shock or a fire.

When Recycling



Always follow instructions

If there is a possible danger of a child getting trapped inside while the refrigerator is not in use, please pull off the door seal.

It is dangerous if the child gets shut inside.

When disposing of the unit, transfer it to the store that you purchased it or to the municipality.

If it is neglected and refrigerant (gas) leaks, ignition or an explosion may be caused due to heat from a fire.

⚠️ CAUTION

Installing and Transporting



Always follow instructions

Install on a strong level floor and adjust the adjustable legs to fix firmly.

The refrigerator may move and cause injury. → Page 4~5

When carrying, use the handles made for carrying.

If other parts are held while carrying, it can cause injury. → Page 14

Be careful not to damage the floor or injure yourself when moving the refrigerator.

Lay a protective sheet on the floor and move the refrigerator slowly.



About using your refrigerator



Do not do

Do not force food items into the refrigerator. Do not use force to pull out shelves.

Food items may fall out, causing injury.

Do not store bottles in the freezer compartment.

If the center freezes and bottles crack, it will cause injury.

Do not place your hands or feet under the refrigerator.

You can get injured from something such as the steel plate.



Do not eat foods that have a bad smell or are discolored.

Doing so may cause food poisoning or other illnesses.

Observe the following when opening and closing the doors.

- Do not open or close the doors when another person is touching the refrigerator.
- Do not put your fingers on the top edge of a drawer type door while closing it.
- Do not open or close the doors with excessive force. (Food may fall out and cause injury.)
- Be careful not to trap your fingers or any other part of your body.
- Be careful not hit a part of your body.
- Do not trap your feet with the bottom drawer. (Danger of your toes caught by the drawer.)



Not doing this may cause injury.

Do not touch foods or containers in the freezer compartment with wet hands.

Doing so can cause freezer burn.



CAUTION

Please take care when removing ice from the ice box.

Built-up frost may cause injury when removing.



Always follow instructions

Make sure that glass shelves or pockets are attached properly.

If insufficiently attached, it may fall out and may cause injury.

From installing to running your refrigerator

1 Installation

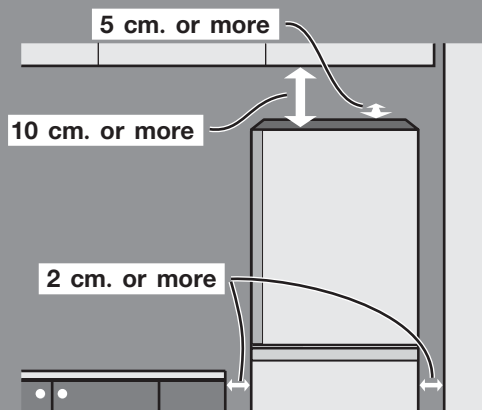

Where to install your fridge

- **Install in a place where there is no direct sunlight or heat, and with good ventilation.**

This protects against a decrease in cooling power and saves on electricity bills.

- **Install in a place with low humidity.**

This prevents rust, electric shock or fires from occurring.

- **Install on a solid and level floor.**

This prevents vibrations, noise, and partially open doors or doors left ajar.

Prevent changes or discoloring by its mass or heat.

※ If the refrigerator adjustment feet sink easily into the flooring material, please lay a strong board on top of the flooring.

- **Install away from other appliances.**

This prevents noise or image disturbances to the television, etc.

- **Leave a space of more than 2 cm to the left and right, and more than 10 cm from the ceiling, and more than 5 cm from the back.**

This is to allow heat to escape from the top, the back and sides.

※ If refrigerator is too near to the wall, it will cause the sound.

Please care to remove the dust within the gap.



Do not get wet

Do not install in an outdoor area where water can get on it or where there is a lot of moisture.

Due to insulation failure, it may cause an electric shock or fire.



Always follow instructions

Allow some space around the refrigerator.

If the refrigerant (gas) leaks, it can remain in the area and there's a risk that it may cause a fire or explosion.

2 Turning on the power

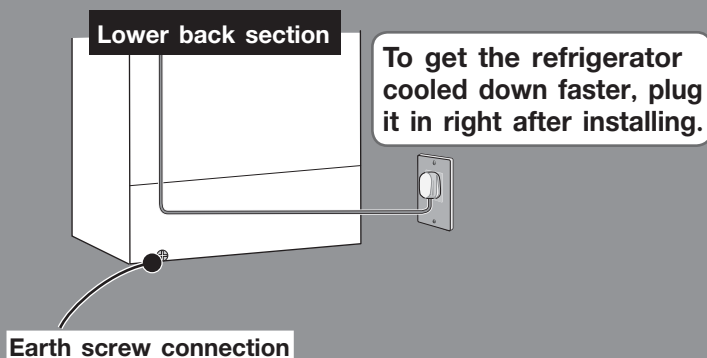

- **Turn on the power of the refrigerator as soon as possible.**

The refrigerator will not be damaged even if you turn on the power immediately after the installation.

Use a dedicated outlet for the power supply that meets the rating specified on the rating label.

How to remove the energy label

- Remove the energy label carefully. A glue residue may remain, particularly if the label has been in place for a long period of time.
- Apply either Eucalyptus or Tea Tree oil directly on any residue.
- Do not allow the oil to run or drip onto plastic parts as it may cause the plastic to degrade and potentially crack over time.
- Allow the oil to sit for approximately 1-2 minutes, or until the glue residue has softened.
- Wipe off with a damp cloth.
- If any residue remains, repeat the above process.
- Rinse with clear water.
- Dry thoroughly.

3 Adjustment and affixing (to provide half-opened door/noise/move/vibrate)

Turn the adjustable legs to get them to touch the floor, then affix.

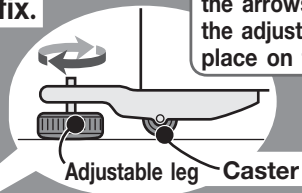
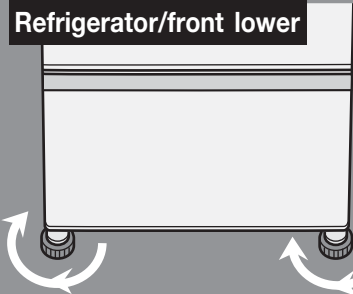

Turn in the direction of the arrows and lower the adjustable legs to place on the floor.



Fix firmly by adjustable legs in the level and strong floor.
The refrigerator may move and cause injury.

※ Before adjusting, please pull the leg cover to the front and remove it.

● Please fix the tilt by adjusting the legs.

Please adjust the adjustable leg as the following picture to level the refrigerator.

If the left side of the door is sagging

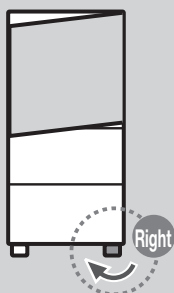

Raise the right side

If the right side of the door is sagging



Raise the left side

Keep the front at a slightly higher angle. This makes closing the door easier and prevents the door from partially opening.

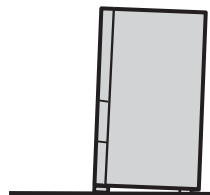

※ After several days from installing, it may sink to the floor by weight. Please re-adjust the adjustable legs again.

When the tilt cannot be corrected with the adjustable legs.

If installed in a corner of a room, there are times when one side of the back legs sinks into the floor. When that happens, please make adjustments in the rear with caster support (separately sold) or a strong board underneath (normally, the thickness of the board should be 2 – 3 mm.)

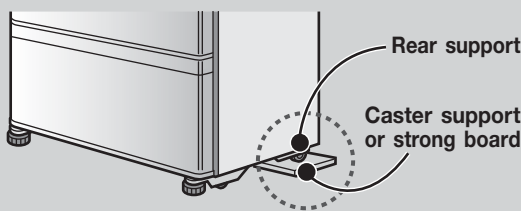

For the caster support, please contact to the shop where you purchased.

● After adjusting please insert the toe grille.

(Toe grille included in the refrigerator)

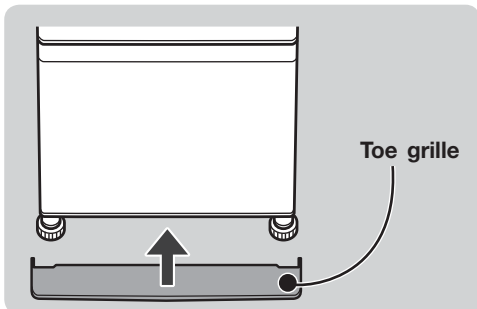

Please insert in parallel until the cover hit in depth.

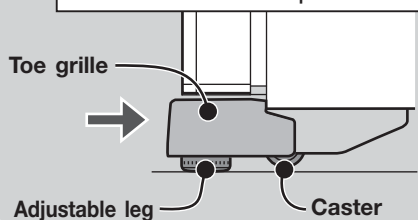

Start using

- **It takes time to cool down.**
 - Put in warm food items or ice cream after the refrigerator has been adequately cooled down.
 - Keep opening and closing of the door to a minimum, and open in a short time.
 - In the summer, it will take approx. 24 hours to make the first batch of ice.
- **It may smell of plastic.**
 - The smell will gradually disappear. Please ensure room is adequately ventilated to remove odors.
- **When the refrigerator is in cooling mode the following may occur (also occurs during summer).**
 - The side will be hot allowing the outside of the refrigerator to cool.
 - Operating noise will loud due to the compressor being in high-speed operation.

Do not damage the refrigerant circuit (piping) of the refrigerator; do not drive in screws.
Because a flammable refrigerant (gas) is used, there is the danger of igniting or explosion.

Do not do

Use in hot spring areas

Corrosion control treatment must be applied for the refrigerant circuit (pipe) due to generation of corrosive gases. Contact the retail store where you purchased the refrigerator.

Using each compartment

Refrigerator / Sliding case

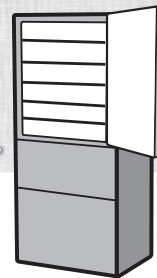

Insert drinks or immediately used foods in refrigerator compartment. Sliding case can store meats, fish, dairy products, processed foods, etc. at a lower temperature than the refrigerator compartment.

Refrigerator

How to remove shelf, pocket, case → Page 12

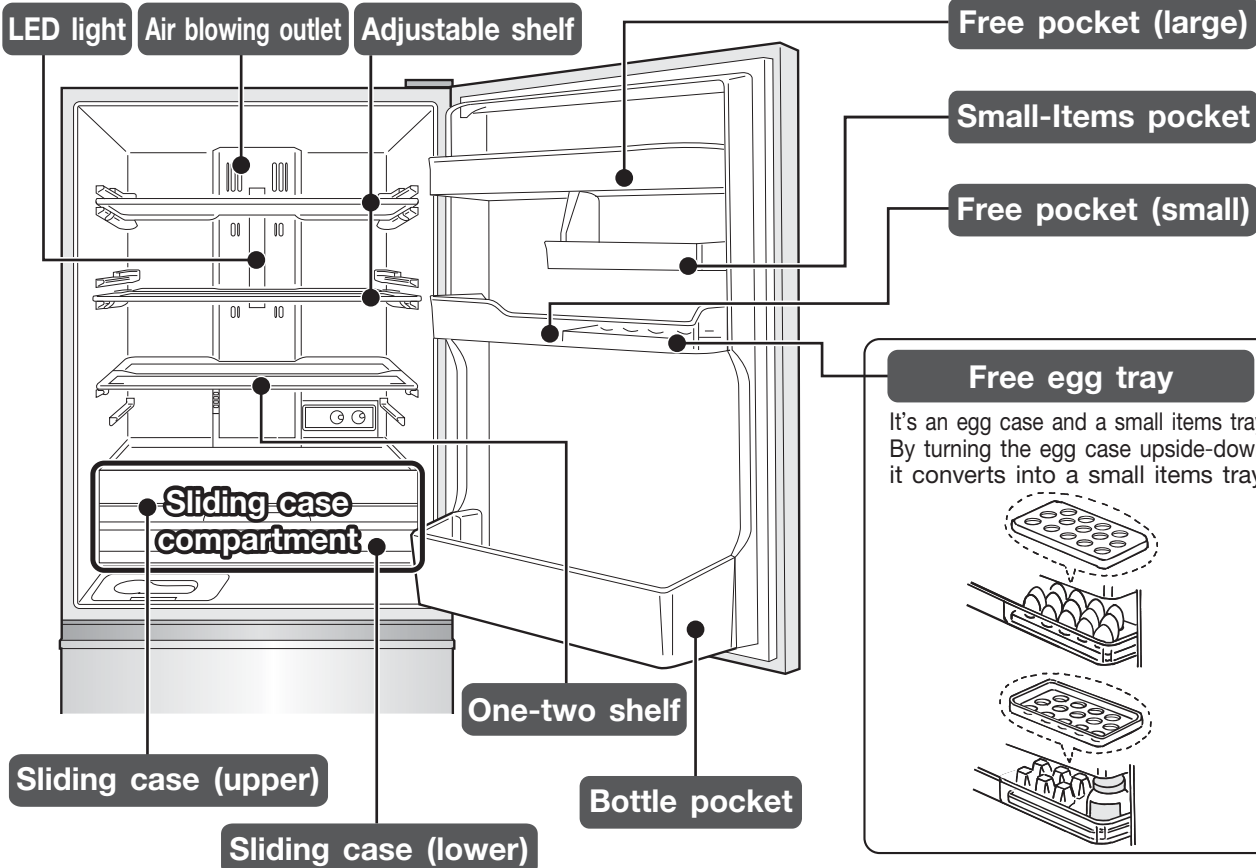

Free egg tray

It's an egg case and a small items tray. By turning the egg case upside-down, it converts into a small items tray.

※ Illustration of MR-CX363ER

One-two shelf

The layout of shelves can be rearranged.

It makes a large space when set up by overlapping back of the shelf.

The shelf can be added by set the lower level. Install a space to accommodate tall stuffs in front.

Air blowing outlet

Food items with a lot of moisture may freeze if put near air blowing outlet. (Especially canned beer or carbonated drink, there is a risk of rupture when freezing.)

Air blowing outlet

MR-CX328ER has 6 places.
MR-CX363ER has 8 places.

To prevent odors?

We recommend you wrap or store the foods in airtight containers.

<p>Foods with strong odor</p> <p>Kimchi, dumplings, sardine (seafood), beef, etc.</p>	<p>Foods that easy to absorb odor</p> <p>Rice, potato salad, etc.</p>
--	--

Door alarm will inform when the door is left open. → Page 8

Vegetable compartment

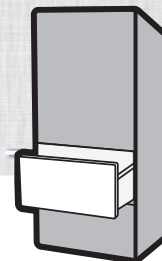

Please insert fruit, vegetables and drinks.
If you wrap fruit and vegetables, they will stay fresh longer.

Sliding Case
For smaller items that get damaged easily such as tomatoes and fruit.

Vegetables Case

LED light in the vegetable case
The LED light with specially selected light spectrum installed in the Vegetable compartment can increase the Vitamin C and preserve freshness in green vegetables by introducing photosynthesis process.

Before use

Operation

Cleaning

When in trouble

Please note

Do not put tall items in the sliding case.

- It can damage food items or damage the sliding case.
- If the sliding case is taken out and used separately, the vegetable compartment will become dry.

Suggestions

- Store vegetables using transparent containers or wrappings to enable exposure to the LED light.
- With exposure to the LED light, photosynthesis process for green vegetables will be enabled, the effect will depend on the initial freshness of the vegetables stored.
- Do not use any sharp objects to scratch or adjust the LED light to prevent damage which may affect its normal operation and effectiveness.
- Do not use any sharp objects to scratch or adjust the LED light to prevent damage which may affect its normal operation and effectiveness.
- To prevent discoloration of the plastic parts, store cut citrus fruits in plastic wrap or containers.

Freezer compartment

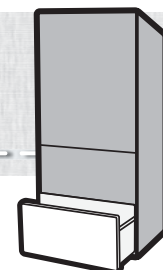

You can storage frozen food, ice cream, bread, meat, fish, etc.

Freezing Case (upper)

Ice Storage Container

Freezing Case (lower)

Door alarm will inform when the door is left open.
→ Page 8

Notice

Put foods in the Freezing Case to below the embossed line level seen at the front.

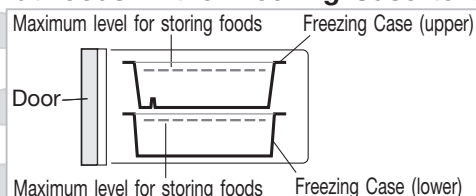

- When closing the door, food can get in the way causing the door not to close properly. This can cause frost to form in the inside, or improper freezing, and will cause a malfunction.
- This may damage food and the freezing case, as well as the automatic ice-maker.

※ For the temperatures indicated, the freezer and refrigerator compartments were adjusted at the "Normal" position, with an ambient temperature of 30 °C, with refrigerator doors closed and containing no food; after the temperature stabilized, the temperature criteria was measured toward the lower-mid interior of the refrigerator.

How to adjust the temperature

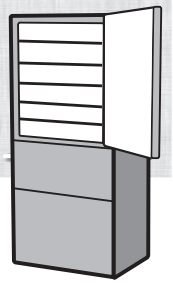

You can stop ice-making, adjust the temperature in refrigerator/freezing compartment by using the operation unit in the back of the refrigerator compartment.

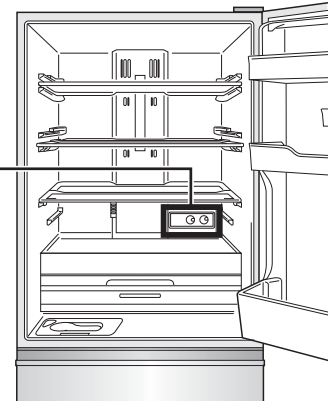
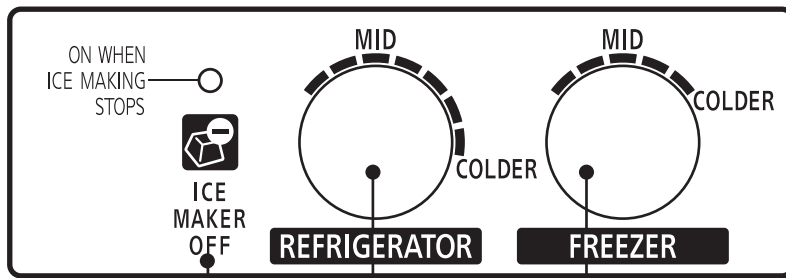

※ Illustration of MR-CX363ER

Ice-making stop setting

- Ice-making stop light (red)**
Red light off...Auto ice-maker is working.
Red light on...Auto ice-maker is stopped.
- Ice-making stop switch**
Press when you want to stop auto ice-making, or restart ice-making. → Page 10

Freezer compartment

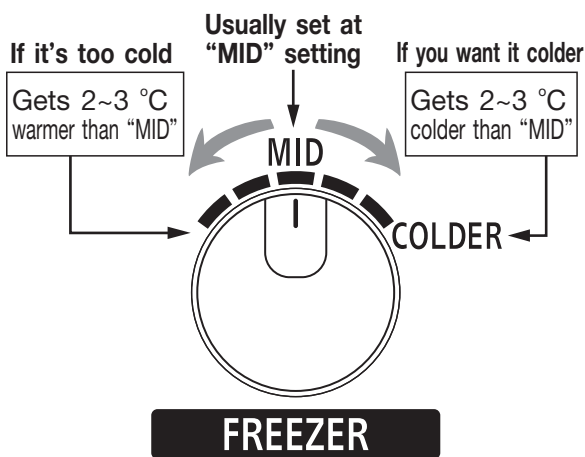

Refrigerator and Vegetable compartment

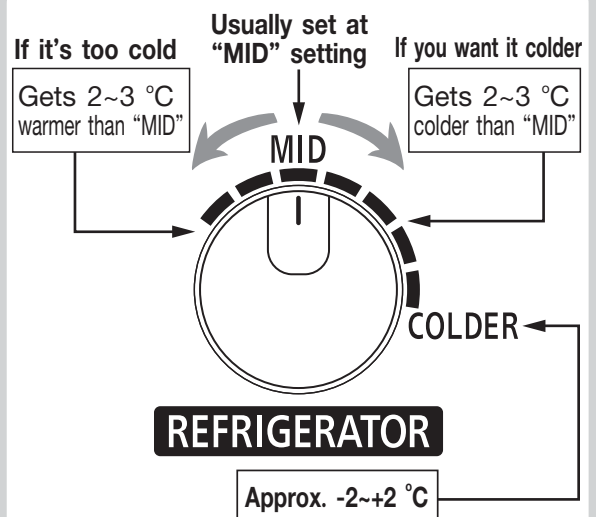

The refrigerator compartment can be switched over to be a chilled compartment.

Chilled

For storing meat, fish, processed foods (dumplings, etc.) and yogurt for around 1 week.



When door alarm ringing

When the refrigerator or freezing door is open for more than 1 minute, the door alarm will work to inform you.

The number of times of sound by the door opening time are as the follows.

Door opening time	1 min.	2 min.	3 min.	4 min.	More than 5 min.
Alarm sound	Pi Pi Pi Pi Piiii Piiii	Pi Pi Pi Pi Piiii Piiii Piiii	Pi Pi Pi Pi Piiii Piiii Piiii Piiii	Piiii continuity after Pi Pi Pi Pi	Pi Pi continuity

- Make sure that the door is not half-opened, and pinching the foods (at the back of packing/case) (please check one time a month).
- Door open-close sensor is attached in the doors of refrigerator/freezing compartment.

If alarm does not stop after the door is closed, please check "When alarm non-stop" → Page 15

Automatic Ice-Maker

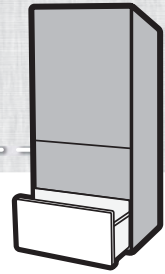

You can make ice cubes by putting water in the water supply tank of the refrigerator compartment. Please do periodically maintain to make a good ice cube by cleaning. Please drain the water in the water supply tank when you do not make ice.

Before use

Operation

Cleaning

When in trouble

About the first batches of ice.
Please discard the first 2 - 3 batches of ice (approx. 30 cubes) made at the very beginning. Also, discard ice that isn't used in over 1 week. There may be times when there may be dust or an odor on them.

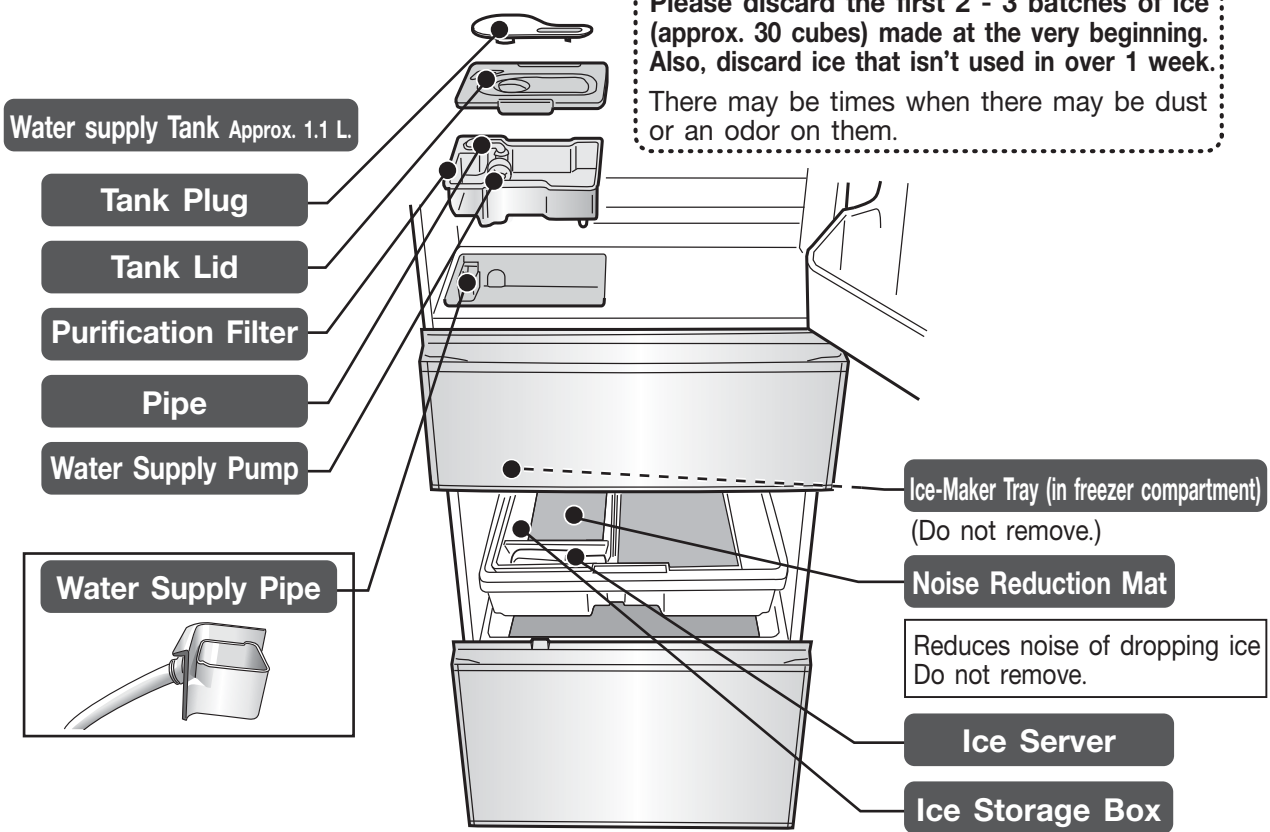

Water to Use for Your Auto Ice-Maker.
We recommend that you use water such as tap water which contains less bacteria. If you use mineral water or water from a filtering machine, please increase the number of cleaning times, and be sure to clean it thoroughly. → Page 13

How to make ice

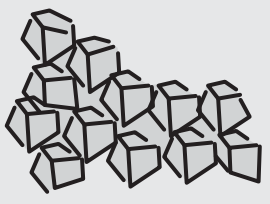

WARNING
Fill with potable water only.

1 Take out the water supply tank, remove the tank plug, and fill with water.

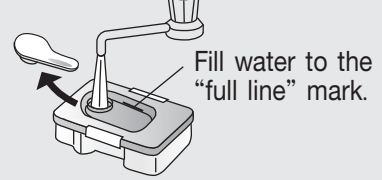

How to remove the tank plug.
Turn to the "Open" position and lift off.

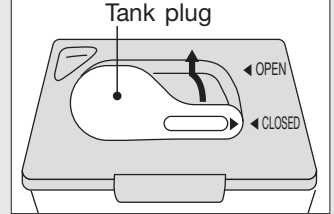

2 Put the tank plug on the water supply tank, carry carefully without tilting it, and return to its original position.

- When carrying the water supply tank, make sure that the "▶" symbol is in the closed position.
- If the tank is tilted, water will spill out.
- If the water supply tank is not properly in position, ice cannot be made. Make sure that there is nothing blocking the tank receiving area.

How to put in the tank plug.

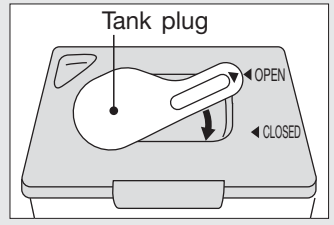

To stop ice-making

Press  button when the ice-making stop light (red) is off.

The ice-making stop light (red) will turn on.

- The red light is on when ice-making stopped.

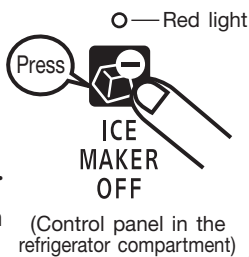

To restart ice-making

Press  button when the ice-making stop light (red) is on.

The ice-making stop light (red) will turn off.

When you will not make ice for a long time ※ Also do this when moving or transporting unit.

Empty the ice-making tray by taking out the ice or by forcing water to go into the ice storage box.

1 Take out the water supply tank, close the freezer door.



2 Press  for about 5 seconds. (at temperature adjustment panel, inner back of refrigerator compartment.) - (Press until it makes a beeping sound.)

- The Stop ICE MAKER OFF light (red) will blink for about 1 minute. (It drops down the ice-making tray's water or ice.)
- When the light stops blinking, it will return to the previous indication.

3 Take out the freezing case (upper) and the ice storage box. And discard water or ice.



4 Stop making ice.

- If the ICE MAKER OFF light (red) is off, press  and check to confirm that the ICE MAKER OFF light is on.

5 Wash with water, dry, and put back in place: the water supply tank (water supply pump, pipe, water filter), freezing case (upper), ice storage box and the noise reduction mat. → Page 13

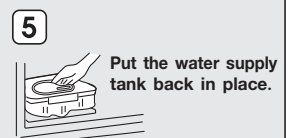

To restart ice-making, press  to cancel the ICE MAKER OFF function. (The ICE MAKER OFF light will go off.)

Please note

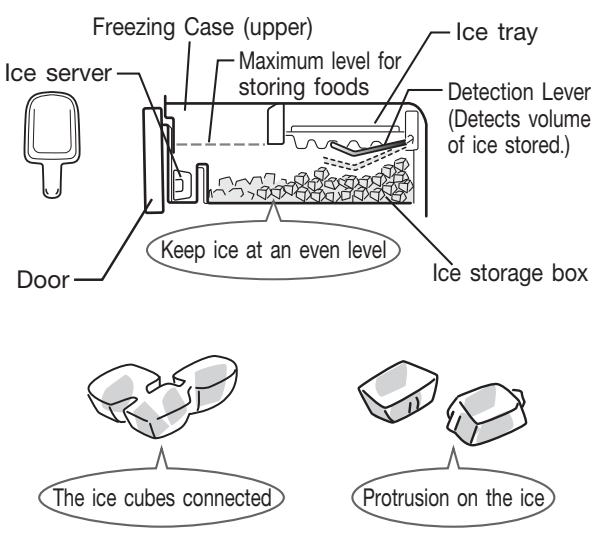

- Do not put the food items in ice storage box when making ice.
- Please do not store anything above the level on the side of the freezing case (upper). (The door may half-open and it may cause failure/damage.)
- Do not insert any drinks such as hot water, juice, tea, soft drink, etc. other than water in water supply tank (heatproof temperature 60°C). It may cause failure.
- Ice-making will stop when the amount of storage ice is given quantity. Ice cube will flat when it thick some, please insert ice server horizontally in front side of ice storage corner as the left figure.
- Please gently close the door of freezing compartment. Ice cube may get dirty.
- Do not insert water over full water mark in water supply tank. Water channel in the ice tray may freeze, ice cube may connect together, and convex may come out, if insert water over the mark or pour water by kettle.

About the ice

- Ice made with water containing a lot of mineral substances such as mineral water, can cause to ice to form with a white sediment (white crystals). These are only mineral substances that have become crystallized. It is harmless.
- If ice is stored for a long period of time, the ice cubes may cling together or become smaller. (This is known as the phenomenon of sublimation.)

- Ice-making may take longer with frequent opening/closing of the door, or depending on the ambient temperature.



Please pay enough attention when crush the ice which stuck in ice storage corner.
It may cause injuries.

How to remove and clean accessories



Always unplug electrical plug from socket

Unplug the electrical plug.

If it is not unplugged, it will cause an electric shock.



Do not do

Do not take apart, repair or convert. Do not continue to use with damaged parts.

This can cause injury, an electric shock or a fire.

※ Wait 10 minutes or more before you replug the electrical plug into the outlet. If you plug it in immediately after unplugging it, the refrigerator will not run.

How to maintain Q&A



Q. If dirt is noticed.

A. Please wipe as soon as possible.

- Wipe with soft towel soak with warm water.
- For hard to remove dirt, please use a kitchen detergent (neutral type) and wipe off with water.
- In particular, oil may lead to cracks and citrus fruit juices to discoloration, so be sure to wipe them off right away.
- Door packing may cause damage or cold air leakage if you leave the dirt. Please wipe off the moisture with dry towel after wipe off with soft and soak towel.

Q. Can the shelf, case and pocket be removed?

A. For removable parts, please see → Page 12

Please take heed

● Do not use the following items.

Alkalinity or alkalescent kitchen detergent, undiluted neutral kitchen detergents, polishing powder, soap powder, alcohol, benzine, thinner, petroleum, acid, scrub brush, hot water, etc.

Plastic parts (door handle, cap, case, etc.) will crack, and glass shelf or painted surface may damage or rust.



Power Plug

For safety, please do periodically care of power plug and cords.

- ① Unplug the electrical plug from the outlet and inspect.
- ② Is there any damage or abnormal heat coming from the plug or cord?
- ③ Wipe away dust from the plug and around the plug area with a dry cloth.
- ④ Insert the electrical plug fully into the outlet.

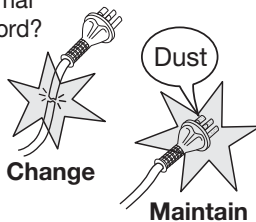

Always follow instructions

Wipe out the dust in power plug periodically.

It may cause fire or insulation failure.

Refrigerator rear side and floor

Dust and dirt can accumulate in the ventilation space behind the refrigerator. Please clean periodically for energy saving purposes.

- ① Remove the toe grille.
- ② Turn the adjustable supports to raise them from the floor, and pull out the refrigerator. **We recommend laying out protective material on the floor to prevent the floor from being damaged. Also, be careful not to injure yourself.**
- ③ Remove the dust from the rear panels, walls and floor, and wipe off any dirt.
- ④ Check for water dripping on the floor.

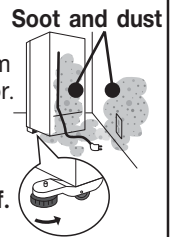

Do not do

Do not put your hands or feet under the refrigerator.

It may cause injury.

Before use

Operation

Cleaning

When in trouble

Use reverse procedures to put accessories back in place.

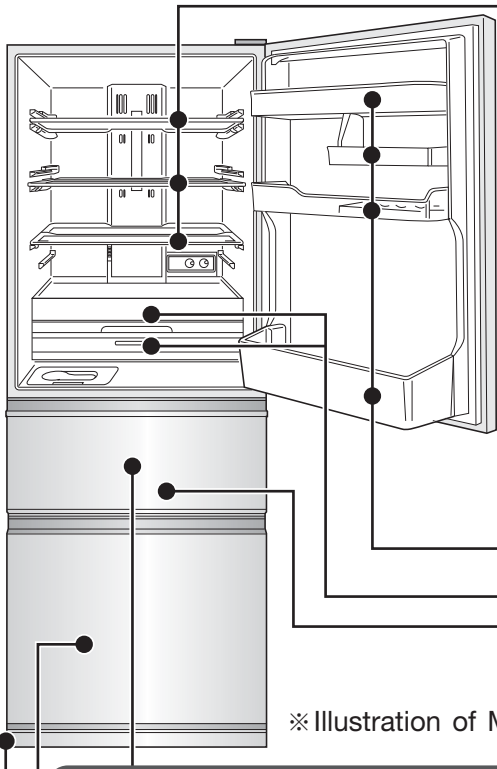

※ Illustration of MR-CX363ER

Glass shelf / One-two shelf

- 1 Lift up the front side by both hands.
- 2 Pull forward and take out.

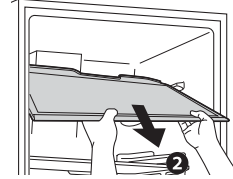
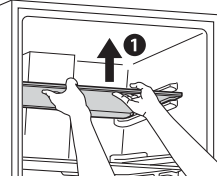

※ If forcefully pulled outward damage may occur to door side. Please slowly pull and take out.



Always follow instructions

To ensure that glass side is attached or removed.

If the glass is not attached properly, it will out and falls which may cause injury.

Free pocket (large), (small) / Bottle pocket / Small-Items pocket

- 1 Lift upward holding right and left sides.

※ The piece is attached quite firmly.



- 2 Draw forward to remove. **Bottle pocket**



Always follow instructions

Make sure that you removed and attached properly.

It may fall if not attached properly, and may cause injury.

Vegetable Compartment

- 1 Open the drawer-door fully.

- 2 Lift out the case.

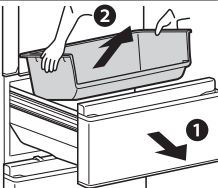

- 3 Take out the small vegetables case. While lifting the drawer-door slightly, draw out and tilt downward.

- 4 Lift out the case.

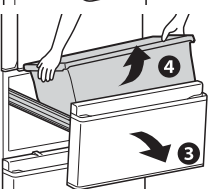

Freezer Compartment

- 1 Open the drawer-door fully.

- 2 Lift up the freezing case (upper) towards you.

- 3 Take out the freezing case (upper), and while slightly lifting up the door draw out and tilt downwards.

- 4 Lift up the freezing case (lower) towards you.

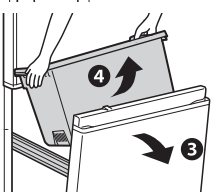
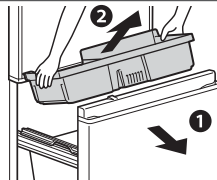

Toe grille

- 1 Remove by pulling forward on both sides.

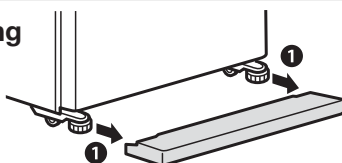

Point when attach free pocket

Insert the left and right partway, push the top of claw part in the center of free pocket, and fit the claw part.

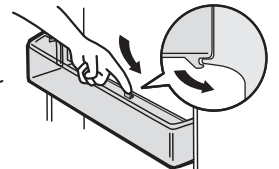

Sliding case (upper), (lower)

- 1 Pull forward.

Sliding case lid

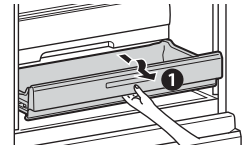
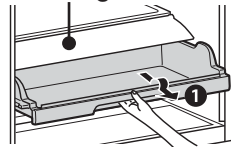

Sliding case (upper)

Sliding case (lower)

※ Sliding case lid cannot be removed.

※ If difficult to take out, please remove sliding case after removing the bottle pocket.

Liquid-Catching Indentations

Wipe away any dirt, liquid or condensation.

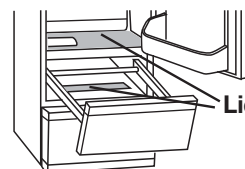

Liquid catchers

How to maintain your automatic ice-maker

Please do periodic care to prevent the occurrence of water scale, mold, etc. Please remove water when not making ice.

※ Do not use a dishwasher or dryer because it may cause deformation.

For once-a-week Water supply tank / Purification filter

If mold forms easily in the certain types of water, clean about 2 or 3 times a week.

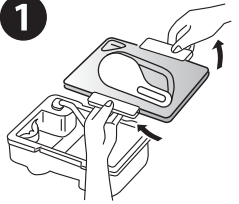
1  **Take off the lid and wash with water.**
(Temperature tolerance approx 60 °C)

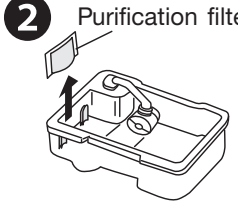
2  Purification filter

Remove and wash with water. Normally, it does not need replacing. Please replace for the following reasons:

- If something other than water was put in and the opening got blocked.
- If it is damaged.
- If mold, etc. is forming.

To buy another filter, please inquire at the store where you bought your unit.

For once-a-month Water supply pump

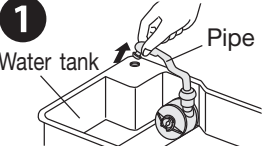
1  **Remove it from tank.**

Pointers for assembling the water supply pump

If it is not assembled properly, it may not make ice or it may make a loud sound. Please check on the following.

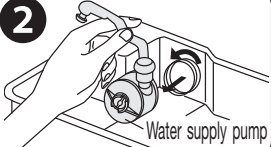
2  **Turn the pump and take out.**

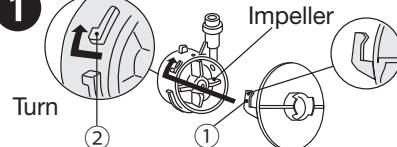
1  **The claw on the cap (1) is turned to put onto the protruding part (2) of the water supply pump.**
※ Check to make sure that the impeller is inside.

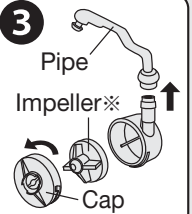
3  **Take out the pipe, Turn the cap and remove, Take out the impeller and wash with water.**
※ The impeller is made with a magnetic material. Clean thoroughly with water, making sure there are no substances on it.

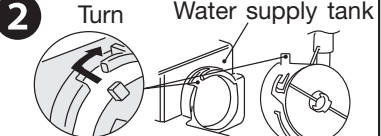
2  **Attach the water supply pump properly to the water supply tank by turning and attaching.**

4 Return parts by following the reverse procedure.

3  **Insert the pipe into the water supply tank opening, Connect the pipe to the water supply pump.**
※ Check to make sure that there are no substances at the connection point of the two pipes.

For once-a-month Water supply pipe

1  **Take out the water supply tank.**

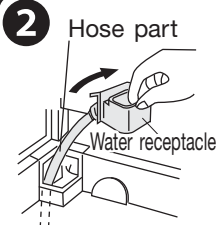
2  **Take out the water supply pipe and wash with running water.**
The water receptacle and hose part cannot be removed.

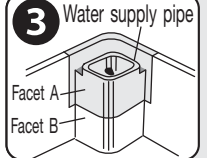
3  **Return back to original positions.**
Make sure to insert the water supply pipe properly so that there's no difference in surface level between facet A and facet B is.
Return the water supply tank and, if does not sit in properly, re-set the water supply pipe. If removal or assembly are not done correctly, a problem such as a water leakage will occur.

Cleaning the ice-making tray (rinsing)

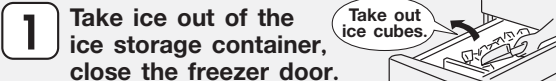
1  **Take ice out of the ice storage container, close the freezer door.**

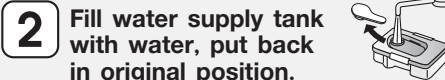
2  **Fill water supply tank with water, put back in original position.**

3 Press  for about 5 seconds (at temperature adjustment panel at inner back of freezer compartment.)
● The stop ice-maker light (red) will blink for about 1 minute. (It rinses the ice-maker tray with water from the water supply tank.)
● When light stops blinking, it will return to the previous indication.

4 Repeat **3** 2 or 3 times.

5 Remove the Freezing Case (upper) discard water and ice.

Do not throw out the noise prevention mat.

Notice

- Do not use washing agents such as kitchen detergents, benzene or bleach to clean the water filter. It will cause ice to have an odor.
- If you use a bleach to clean your water supply tank or lid, please follow product directions carefully.
- Assemble the water supply pump properly and firmly. If it is not assembled properly, it may not make ice or it may make a loud sound.
- Please attach the lid of water supply tank securely. If the lid is not attached properly, the lid may be out and the water supply tank will fall.

Before use

Operation

Cleaning

When in trouble

What to do in these situations

When there's a power failure

- Minimize opening/closing of doors and avoid putting in more food.

When not in use for a long time (Remove the power plug)

- 1 Clean the auto ice-maker. ➔ Page 10, 13
- 2 Clean the interior after unplugging the refrigerator.
- 3 Keep the door open for 2 - 3 days to let it get dry.
 - ※ If not allowed to dry properly, mold and odors can occur, or refrigerant (gas) may leak due to corrosion of the cooling unit.

When transporting

- 1 Empty any water or ice from the water supply tank and ice-making tray. ➔ Page 10
- 2 Wear protective gear (gloves).
- 3 Remove the toe grille, and then rotate and raise the adjustable leg. ➔ Page 5
- 4 Remove the power plug.
- 5 Lay towels under the drainage port and the lower rear edge of the refrigerator and position a container or tray with a height of about 3 cm. on the towels to collect the water.
 - ※ The towels prevent floor damage, and water from being spilled on the floor.
- 6 Tilt the refrigerator slowly to the rear by about 30 degrees, and drain the water from the evaporation tray via the drainage port on the lower rear side. (The evaporation tray is not visible from the outside.)
 - ※ Because the refrigerator is heavy, the work must be performed by at least 2 people.
 - ※ The work must not be performed by small children or people who are not capable of doing heavy work. Ask a specialist transportation company.
- 7 2 or more people should hold the hand-holds on the lower inside of the front and the upper side of the rear, and carry the refrigerator slowly.
 - Do not lay or load on its side (it will cause damage to the compressor.)



When takes time to move such as relocation

- The frost may melt, and the water may spill from the cooler in back of freezer compartment during transport.
- It may take 1 day from unplug until frost melt.



Do not do

Do not damage the refrigerant circuit (piping) of the refrigerator; do not drive in screws.

Because a flammable refrigerant (gas) is used, there is the danger of igniting or explosion.

When moving the unit / when changing the direction of the unit

- 1 Remove the toe grille, and then rotate and raise the adjustable leg. ➔ Page 5
- 2 When changing the direction of the unit, please use caster wheels or place a protective cloth under the back legs.
- 3 Move in a forward or backward direction.
 - ※ If moved other than in a forward or backward direction, there's a risk of damaging the floor.

What to do in these situations (continue)

When alarm rings continuously

Make sure that each door closes without any gaps.
 Inspection is required due to a possibility that an abnormality has occurred.
 Please contact the store where you purchased the unit.

How to stop alarm (PiPi continuous sound)

You can stop alarm sound temporarily.

Press  button (ice-making stop switch) in control part of refrigerator compartment more than 5 seconds.

※ Please note that if we press  icon to stop door alarm, ice cube or water will be driven to ice storage box. → Please refer Page13 Cleaning the ice-making tray (rinsing).

※ If alarm did not stop, or if alarm continue ring periodically, please check around the device.

When ice-making light (red) blink

Inspection is required due to a possibility that the abnormality has occurred such as the refrigerator not cooling.
 Please contact the store where you purchased the unit.

※ The light (red) may blink during cleaning the ice tray, this is not abnormal situation. → Page 13

Troubleshooting

Please check the following points before request for repair or contact us.
 If the problem cannot be solved, please contact the store where you purchased the unit.

Especially when starting use or summer time

Not cooling at all!

- It takes time to cool when starting use. In summer time, it may take approx. 24 hours until cooling. → Page 5
- Check that it is not unplugged or the circuit breaker has tripped.

Outside of the refrigerator is hot!

- It may hot outside especially after installation or during the summer (approx. 50 – 60°C). It is because there is the heat radiation and dew formation preventing pipes on the side and ceiling. There is no problem in this situation because this operation is necessary to keep the unit cool.
- There is a radiating fan at the bottom, the warm air may come out.

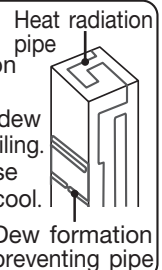

If this happens...		Please check this out.	Please do this. This is the reason.
How to cool	It doesn't cool properly. It only makes small amounts of ice. The ice is melting.	① Is it right after installing the unit?	It will take about 4~5 hours to cool down. During summer, it may take about 24 hours to make ice.
		② Is the temperature adjustment set on a left of "MID"?	Please adjust the temperature to "MID" or "COLDER."
		③ Is the flow of cold air being blocked? Are doors being opened often, or are doors improperly sealed shut?	Please check to see that too much food isn't placed in the refrigerator and that the door is properly sealed shut.
		④ Is there not enough space around the unit, is the sun directly on it, or is the radiation of heat being blocked?	Please check to see that it's installed properly. → Page 4
Foods get frozen in compartments besides the freezer.	① Is the refrigerator compartment temperature set at "COLDER" or at right of "COLDER"?	Please adjust the refrigerator compartment temperature to "MID."	
	② Are foods with a lot of moisture placed at the back end of the shelf?	Please put foods such as tofu, vegetables, fruit, and foods with a lot of moisture or drinks towards the front part.	
	③ Is the ambient temperature less than 5 °C?	If the freezer compartment temperature is adjusted to a left of "MID", foods will be less likely to freeze. → Page 8	

Troubleshooting (continue)

	If this happens...	Please check this out.	Please do this. This is the reason.
Automatic Ice-Maker	It doesn't make ice at all Water in the tank doesn't decrease It takes too long to make ice.	① Is it just a short time after installation?	It takes about 12 hours to make the first batch of ice. In the summer, it may take about 24 hours.
		② Are food items or the ice server left in the water supply box?	The ice-maker will judge that there is a lot of ice. Please take food items, etc. out of the ice storage box. Also, please level the ice evenly to the forefront.
		③ Is the ice-maker in the "ICE MAKER OFF" setting? (red light on.)	Please turn off the "ICE MAKER OFF" red light. → Page 8, 10
		④ Are the water supply pump and pipe properly attached to the water supply tank?	Please place the outlet for the pipe inside the tank correctly. → Page 13
		⑤ Is there enough water in the water supply tank? Is the refrigerator tilted?	The number of ice cubes in one batch may be reduced. Pour water into the water supply tank. → Page 9
	Water supply tank/pipe freeze.	① Did you attach water supply tank/pipe in refrigerator compartment without any gaps? Or, did you attach tank pipe in water supply tank without any gaps?	Please check the attachment around water supply tank. If there is a gap, cool air may leak and water may freeze. → Page 13
Ice cube is small Ice cube stick together.	① Was the ice cube in the ice storage corner for a long time?	The ice cube will become small or stick together if put in the ice storage corner for a long time (calls sublimation). We recommend you to stop doing ice-making when not use the ice cube. → Page 8	
There are protrusions on the ice. 2-3 cubes get connected.	—	This is because there is a waterway that flows water evenly into the ice-maker tray. Please do not fill water above the "full line" mark on the water supply tank.	
The ice has white "things" in it.	① Are you using mineral water to make ice?	If ice is made with water that has a lot of mineral substances, white sediment may form inside the cubes. It is harmless.	
Sound	Clattering sound.	① Did the surrounding items make contact with the refrigerator?	Please give a gap around. It makes sound when the refrigerator connect with the goods or walls.
	It's got a loud sound It's got sounds that worry me The following sounds do not mean there's a problem.	① The sound suddenly gets louder. The sound changes.	If it is right after installation, or hot out, or if doors are open/closed often, it goes into high-speed operation to chill with greater power.
		② There's a "phyoon" sound when I close the door.	This is the sound of the fan motor starting up.
		③ When I open the door, there's sometimes a "krik" sound coming from the inside, or a sound like water running.	This creaking sound occurs when warm air enters and the plastic expands.
		④ Sometimes there are sounds like "shuu" or "plub-plub" (boiling water sound) or "shaaa"(water flowing sound).	This is the sound of refrigerant (gas) flowing through.
		⑤ Sometimes there's a "wheeen" or "klik-klak" sound (every 1~2 hours).	This is the auto ice-maker sound. Even if there's no water in the water supply tank, the auto ice-maker and the pump will make a sound about every 100 minutes.
⑥ After plugging it in, there's sometimes a "gu" or "gween" sound (every 1~2 hours) when the ice-maker is off.	This is the sound of the auto ice-maker doing a operations check. Even when it is on "ICE MAKER OFF" it will do the checking.		
Doors	Doors open easily Doors don't close.	① Is food or a case blocking the door?	Put away items properly so that they don't interfere when closing the door.
		② Is there food caught at the back of the case of a drawer-door? Is the electrical cord caught between the body of the unit and the door?	Remove the item. Please do not let food items, the electrical cord, plastic bags, etc. get in the way.
		③ Does the refrigerator wobble or seem unstable? Are the adjustable legs touching the floor?	Bring the adjustable leg down, and raise the front higher, with a slightly raised front, closing doors becomes easier. → Page 5
Alarm rings.	① Make sure again that you close the doors properly.	Please check "when alarm rings", "When alarm did not stop". → Page 8, 15	

Troubleshooting (continue)

If this happens...		Please check this out.	Please do this. This is the reason.
Dew/Frost	Dew attached in the outer or inside the refrigerator Frost adhere to the freezer compartment Water dripping on the floor.	① Did you open the door frequently, or are there gaps?	Please close the door properly. Dews and frost will come out when the moisture in the air is cooled. Dews and frost attach when the humidity is high.
		② Is there a time of rainy weather or elevated humidity?	Dew may temporarily attach. Please wipe with dry towel. And frost is easily attach in the freezer compartment.
Others	There is a scratch line in transparent parts.	① Is the surface in a thin line stepless in both sides?	It is a mark get when molding of the plastic. It seem a resin molding mark. It is not a scratch.
	I get static noise from the TV, etc.	① Is the refrigerator installed near a TV?	Please set your refrigerator at a distance from TVs, etc.
		② Is the power source for the refrigerator taken from near the antenna cable inlet?	We recommend a single power outlet and that earthing is checked.
The odor bothers me (Food items / ice).	① Have you put in strong-smelling foods without using a food wrap?	If the smell is strong, the odor-removing device cannot remove it all, so please wrap such items.	
	② Is the water supply tank unclean?	Please do a regular cleaning maintenance. →Page 13	

Non-Freon Refrigerator

- This refrigerator uses non-freon foam insulation material. Non-freon foam insulation material (cyclopentane) does not deplete the ozone layer and their contribution to global warming is extremely low, making them environmentally friendly substances.

To economize power

Quickly open and close the door

Cold air may leak outside, or power consumption may increase if open a long time or open the door frequently.



Do not block the air outlet or suction port

The foods may not easily get cold if block the cool air. The temperature near air outlet may decrease, moist foods may easy to freeze.

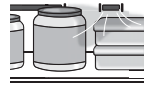

Leave some space between the foods.

Cool air may not flow very well, the foods may not easily get cold if you not leave a space between the foods.



Leave space

Cool down hot foods before put in the refrigerator

The temperature inside may rise, and may affect to freshness of the other foods.



With low energy
Protect the environment Live well

Power saving

Refrigerators use the most electricity of all household appliances. Even a little effort can help to save electricity. Let's all try to save power

Are you putting hot items directly into the refrigerator without allowing them to cool first?

Are you opening the doors more often than necessary?

Is the refrigerator cooling too much?

Tender care inspection

Inspect the refrigerator to get many years of use!



Have you noticed these symptoms?

- The power cord or plug is unusually hot.
- The power cord has a deep cut or is deformed.
- You smell something burning.
- Water is always collecting on the floor under the refrigerator.
- You get shocked when you touch the refrigerator.
- You notice any other abnormality or malfunction.

Stopping use

To prevent an accident or when there is a malfunction, remove the power cord plug from the outlet and be sure to contact your refrigerator retailer for inspections or repairs.

Customer memo

Convenient information when requesting repairs or service

Purchase date

Year Month Day

Retailer

Telephone number

()

Before use

Operation

Cleaning

When in trouble

Accessories

	Model name	MR-CX328ER	MR-CX363ER
	Accessories	Quantity	Quantity
Refrigerator compartment	Adjustable shelf	1	2
	One-two shelf	1	1
	Sliding case (upper)	1	1
	Sliding case (lower)	1	1
	Water supply tank (including purification filter)	1	1
	Free pocket (large)	1	1
	Free pocket (small)	1	1
	Small-Item pocket	-	1
	Free egg tray	1	1
	Bottle pocket	1	1
Vegetable compartment	Vegetable case	1	1
	Sliding case	1	1
Freezer compartment	Freezing case (upper)	1	1
	Freezing case (lower)	1	1
	Noise reduction mat	1	1
	Ice server	1	1
	Toe grille	1	1

■ This appliance is designed for use in Australia and New Zealand only and cannot be used in any other country. No service is available outside of Australia and New Zealand."

MODEL NAME	COUNTRY NAME
MR-CX328ER/CX363ER-A	AUSTRALIA / NEW ZEALAND

When you hear noise from the lower rear of the refrigerator

- Part of the cooling system is the compressor, which operating, does create a more noticeable increase in noise level. This is normal. However, if the noise is quite loud, this could be because the refrigerator is not installed correctly on a hard level surface, or there may be a problem that may need service.

CAUTION

1. This appliance is designed for use in ambient temperature listed below.

MODEL NAME	AMBIENT TEMPERATURE RANGE	CLIMATIC CLASS
MR-CX328ER, CX363ER-A	16 °C ~ 43 °C	T

The internal temperatures could be affected by such factors as the location of the refrigerating appliance, ambient temperature and the frequency of door opening, and, if appropriate, a warning that the setting of any temperature control device might have to be varied to allow for these factors.

2. A rise in temperature of the frozen food during manual defrosting, maintenance or cleaning could shorten the storage life.
3. Food to be frozen is not to be placed in direct contact with food in storage and, if appropriate, that it could be necessary to reduce the quantity to be frozen if freezing every day is anticipated.
4. The electrical power failure for 1-2 hour will only slightly affect the inside temperature. However, opening and closing the door results in temperature loss. In case there is more than 24 hours electrical power failure, the food should be taken out from the fridge.
5. In case you are leaving or there is no food in the fridge for more than 3 weeks, The fridge should be unplugged and cleaned.

MEMO

Before use

Operation

Cleaning

When in trouble

- The appliance is not intended for use by young children or infirm persons without supervision.
- Young children should be supervised to ensure that they do not play with the appliance.
- WARNING - Do not use mechanical devices or other means to accelerate the defrosting process, other than those recommended by the manufacturer.
- WARNING - Do not use electrical appliances inside the food storage compartments of the appliance, unless they are of the type recommended by the manufacturer.
- WARNING - Just in case of having damaged the refrigerant circuit, do not use electric items or fire equipments near by, and open the window to ventilate the room. And contact the retail store at which you purchased it or the following MITSUBISHI SERVICE CENTRE.
- WARNING - When positioning the appliance, ensure the supply cord is not trapped or damaged.
- WARNING - Do not locate multiple portable socket-outlets or portable power supplies at the rear of the appliance.
- The refrigerator contains flammable refrigerant (R600a: iso-butane).
- The refrigeration system behind and inside the refrigerator contains refrigerant. Do not allow any sharp objects to come into contact with the refrigeration system.
- Do not block the openings on the circumstances of the refrigerator.
- The user manual should be handed over to any person who would use or handle the refrigerator whenever the refrigerator would be transferred to another location and delivered to a recycling plant.
- This refrigerator uses flammable foaming gas for insulation. Please deliver the unit to specialized industrial waste dealer when you do away it. Please follow the rules in your country.
- Do not store explosive substances such as aerosol cans with a flammable propellant in this appliance.
- This appliance is intended to be used in household application only.

R600a Refrigerant Warning

- This appliance contains a small quantity of R600a refrigerant which is flammable.
- During transportation and installation, ensure that the tubing of the refrigerant circuit is not damaged.
- Leaking refrigerant can ignite and may damage the eyes.
- In the event any damage does occur, avoid exposure to open fires and any device which creates a spark. Disconnect the appliance from the mains power.
- Thoroughly ventilate the room in which the appliance is located for several minutes.
- Notify Mitsubishi Electric Australia Pty Ltd. for necessary action and advice.
- The room for installing the appliance must be at least 1 cubic metre per 8 grams of refrigerant. The refrigerant quantity contained in this appliance is noted on the Rating Label of the appliance.
- If your Mitsubishi Electric Refrigerator should require service, please contact Mitsubishi Electric Australia Pty Ltd see back page of this user manual for contact details.

NOTE: MITSUBISHI ELECTRIC AUSTRALIA PTY LTD. DO NOT ALLOW SERVICE TO THE REFRIGERATION CIRCUIT OF THIS APPLIANCE.



If an abnormality or malfunction occurs, stop operation immediately and contact the retail store where you purchased the refrigerator or MITSUBISHI ELECTRIC SERVICE CENTRE or its service agent.

SOLE AGENT in Australia MITSUBISHI ELECTRIC AUSTRALIA PTY LTD.

(Incorporated in New South Wales) ABN 58 001 215 792

348 Victoria Road, Rydalmere NSW 2116

For more information and support contact

www.mitsubishielectric.com.au

Call 1300 651 808

SOLE AGENT in New Zealand BLACK DIAMOND TECHNOLOGIES LIMITED (BDT) Wellington Office (Head Office)

1 Parliament Street Lower Hutt PO Box 30772 Phone: (04) 560 9147, Fax: (04) 560 9133

Auckland Office

Unit 1, 4 Walls Road Penrose PO Box 12726 Phone: (09) 526 9347, Fax: (09) 526 9348

Christchurch Office

44 Halwyn Drive Hornby PO Box 16904 Phone: (03) 341 2837, Fax: (03) 341 2838

MITSUBISHI ELECTRIC CORPORATION

NZ79C928H01