

MITSUBISHI

Refrigerator-Freezer

Easy Refrigerator Use



MR-BF290B
MR-BF325B
MR-BF390B

OPERATING
INSTRUCTIONS



Contents

Before using your refrigerator

For your safety, please be sure to follow these instructions. 2

From installing to running your refrigerator. 4

Smart tips for using your refrigerator

How to adjust the temperature. 5

Using each compartment

Refrigerator Compartments. 6

Vegetable case and Freezer Compartments. 7

Maintenance and troubleshooting

How to remove and clean accessories. 8

If you think “is this a problem?” 10

Accessories 11

MEMO

- Please read this manual carefully and follow the information contained within. In particular, be sure to read the safety precautions before using this refrigerator.
- Be sure to receive your copy of the warranty from the retailer and confirm that the purchase data and retailer name are written on the warranty.
- Store this operating instructions manual and the warranty in a safe place.

- This refrigerator was manufactured for refrigerating and freezing of foods in general households. For commercial use, please use a commercial refrigerator-freezer.
- The photographs and illustrations contained in this manual are for the MR-BF325B. While the capacity and dimensions of the MR-BF325B are different from the MR-BF290B, MR-BF390B the operation is the same.
- The principal plastic components indicate the material name to facilitate recycling.

For your safety, please be sure to follow these instructions.

■ The types of danger that can result from improper handling are explained in the sections below.

Warning

Mishandling can lead to serious injury or death.

Caution

Mishandling can lead to bodily injury or loss of home and household contents.

■ The symbols illustrated below have the following meanings.

| | |
|---|---|
|  | Do not do |
|  | Do not touch |
|  | Do not take apart, repair or convert |
|  | Do not get wet |
|  | Do not touch with wet hands |
|  | Always follow instructions |
|  | Always connect an earth wire |
|  | Always unplug electrical plug from socket |

■ When something abnormal or unusual occurs, turn off immediately and consult with “the store where you purchased the unit” or a with a “Mitsubishi Electric repair counter.”

Warning

When installing your unit

Allow some space around the refrigerator.

If the refrigerant (gas) leaks, it can remain in the area and there's a risk that it may cause a fire or explosion.

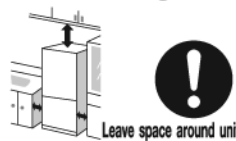

To be prepared for an earthquake, affix to a strong wall or column.

Not doing so may cause injuries from the refrigerator toppling over.



Do not install in an outdoor area where water can get on it or where there is a lot of moisture.

Due to insulation failure, it may cause an electric shock or fire.



Use a dedicated outlet for the power supply that meets the rating specified on the rating label. (The rating label is located on the door-liner of the refrigerator compartment.)

Using an extension cord or plugging in too many power cords into the outlet can cause heat buildup or a fire.



If the power cord is damaged.

If the power cord is damaged call Mitsubishi Electric Service Centre for a technician to replace power cord. The power cord should be designed for this model.



Keep the electrical plug cord facing downwards and insert the plug in fully.

If it is plugged with the cord facing upward, extra pressure gets exerted on it which can cause it to heat up or ignite.



About the electrical outlet and electrical plug

When replacing the interior refrigerator light or when taking care of the unit, pull out the electrical plug.

Not doing so can result in an electric shock or injury.



Do not push the electrical plug with the back of the refrigerator. Do not damage the electrical cord.

If the plug is pressed by the refrigerator, or if the cord is bent, bundled, or a heavy object is placed on it, it can cause an electric shock or a fire.



Do not use damaged cords or plugs or loose outlets.

Using them can result in an electric shock or injury.



Do not remove the electrical plug by pulling the cord.

The cord can become damaged and can cause an electric shock or a fire.



Remove dust from the electrical plug.

Not doing so can cause a fire from insulation failure.



Do not plug or unplug the electrical plug with wet hands.

It can cause an electric shock.



Caution

Installing and Transporting

Install on a strong level floor and adjust the adjustable legs to fix firmly.

The refrigerator may move and cause injury.



When carrying, use the handles made for carrying.

If other parts are held while carrying, it can cause injury.



About Using

Do not force food items into the refrigerator. Do not use force to pull out shelves.

Food items may fall out, causing injury.

























Do not touch foods or containers in the freezer compartment with wet hands.

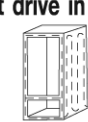









Doing so can cause freezer burn.











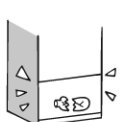

For your safety, please be sure to follow these instructions.

⚠ Warning

| About using your refrigerator | | |
|---|--|---|
| <p>Do not put any vessels, jars, etc. that contain water on top of the refrigerator.</p> <p>If water gets onto electrical parts, it will cause an electric shock or a fire.</p>   <p style="text-align: center;">Do not get wet</p> | <p>Do not use electrical products inside the refrigerator unit.</p> <p>If the refrigerant (gas) is leaking inside the unit, there is a risk that a spark from the electrical product's contact can be a source for ignition or explosion.</p>   <p style="text-align: center;">Do not do</p> | <p>Do not store volatile products that can easily ignite.</p> <p>Benzine, cosmetics and hair styling products can be the cause for igniting fires and explosion.</p>   <p style="text-align: center;">Do not store</p> |
| <p>Do not place items on top of the refrigerator.</p> <p>Items may drop from opening and closing the door and can cause injury.</p>   <p style="text-align: center;">Do not do</p> | <p>Do not store pharmaceuticals or scientific test material.</p> <p>Anything that needs strict supervision must not be stored in a home-use refrigerator.</p>   <p style="text-align: center;">Do not store</p> | <p>Use the specified rated refrigerator light bulb.</p> <p>If you use one that is not specified, it may cause a fire.</p>   <p style="text-align: center;">Use specified products</p> <p style="text-align: center;">Page 9</p> |
| <p>Do not hang on the door or door handle, and do not get on compartment drawer-type doors.</p> <p>The refrigerator can topple over causing injury.</p>   <p style="text-align: center;">Do not do</p> | <p>Do not damage the refrigerant circuit (piping) of the refrigerator; do not drive in screws.</p> <p>Because a flammable refrigerant (gas) is used, there is the danger of igniting or explosion.</p>   <p style="text-align: center;">Do not do</p> | <p>If you sense a gas leakage, do not touch the refrigerator. Open the window and ventilate the room.</p> <p>A spark from the electrical contact can cause an explosion or a fire.</p>   <p style="text-align: center;">Ventilate the room</p> |
| <p>Do not wash with water or spill liquid food items on the unit.</p> <p>If water and food liquids get on the unit, it can cause an electric shock or a fire. If that happens, dry off immediately.</p>   <p style="text-align: center;">Do not get wet</p> | <p>Do not use flammable sprays nearby.</p> <p>A spark from the electrical contact can ignite and cause a fire.</p>   <p style="text-align: center;">Do not use</p> | <p>Do not use in a shed or a garage.</p> <p>If small animals damage the wiring, it can cause an electric shock or a fire.</p>  <p style="text-align: center;">Do not use</p> |

| About Malfunctions / Long Term Care | | |
|--|---|--|
| <p>If the refrigerant circuit (piping) is damaged, do not touch the refrigerator, avoid using any heating flame, open the window and ventilate the room.</p> <p>When the refrigerant circuit is damaged, please consult the store in which the unit was purchased.</p>   <p style="text-align: center;">Ventilate the room</p> | <p>If something abnormal occurs (such as a burning smell), pull out the electrical plug and stop the refrigerator from running.</p> <p>If it continues to run in an abnormal state, it can cause an electrical shock or a fire.</p>   <p style="text-align: center;">Pull out the plug</p> | <p>Do not take apart, repair or convert. Do not continue to use with damaged parts.</p> <p>This can cause injury, an electric shock or a fire.</p>   <p style="text-align: center;">Do not take apart</p> |
| <p>If there is a possible danger of a child getting trapped inside while the refrigerator is not in use, please pull off the door seal.</p> <p>It is dangerous if the child gets shut inside.</p>   <p style="text-align: center;">Remove the door seal</p> | <p>If you will not be using the refrigerator for a long period of time, after pulling out the electrical plug, open the door and let the interior dry out.</p> <p>If it is not dried adequately, the cooling unit may corrode causing the refrigerant (gas) to leak which can then cause the danger of ignition or explosion.</p>  <p style="text-align: center;">Dry properly</p> | <p>When disposing of the unit, transfer it to the store that you purchased it or to the municipality.</p> <p>If it is neglected and refrigerant (gas) leaks, ignition or an explosion may be caused due to heat from a fire.</p>  <p style="text-align: center;">Transfer it over</p> |
| <ul style="list-style-type: none"> ● This appliance is not intended for use by young children or infirm persons unless they have been adequately supervised by a responsible person to ensure that they can use the appliance safely. ● Young children should be supervised to ensure that they do not play with the appliance. ● This appliance is not intended for use by persons (including children) with reduced physical, sensory or mental capabilities, or lack of experience and knowledge, unless they have been given supervision or instruction concerning use of the appliance by a person responsible for their safety. Children should be supervised to ensure that they do not play with the appliance. | | |

⚠ Caution

| About Using Your Unit | | |
|--|---|---|
| <p>Do not store bottles in the freezer compartment.</p> <p>If the center freezes and bottles crack, it will cause injury.</p>   <p style="text-align: center;">Do not store</p> | <p>Do not eat foods that have a bad smell or are discolored.</p> <p>Doing so may cause food poisoning or other illnesses.</p>   <p style="text-align: center;">Do not do</p> | <p>When opening and closing the door.</p> <ul style="list-style-type: none"> ● Do not open or close the door while someone else is in the way. ● Do not place your fingers at the top of drawer-type doors when closing the door. ● Do not close the lower drawers with your foot (as it may get caught). ● Do not open or close the door forcefully (food items may fall and cause injuries)   <p style="text-align: center;">Do not do</p> |
| <p>Do not place your hands or feet under the refrigerator.</p> <p>You can get injured from something such as the steel plate.</p>   <p style="text-align: center;">Do not touch</p> | <p>Close the door by holding the handle.</p> <p>Hold it in a way so that you don't get your fingers caught in the door. Not doing this may cause injury.</p>   <p style="text-align: center;">Hold the handle</p> | |

● For your safety, please be sure to follow these instructions.

From installing to running your refrigerator.

From installing to running your refrigerator.

1 Installation

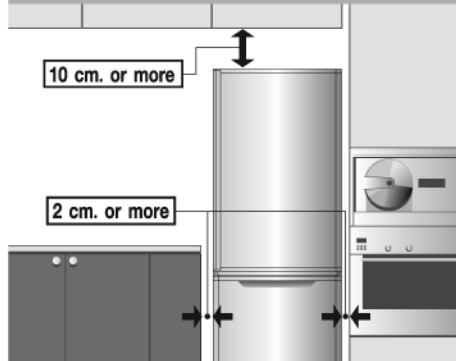

Where to install your fridge

Install in a place where there is no direct sunlight or heat, and with good ventilation.
This protects against a decrease in cooling power and saves on electricity bills.

Install in a place with low humidity.

This prevents rust, electric shock or fires from occurring.

Install on a solid and level floor.

This prevents vibrations, noise, and partially open doors or doors left ajar.

● If the refrigerator adjustment feet sink easily into the flooring material, please lay a strong board on top of the flooring. (Prevents changes or discoloring by its mass or heat.)

Install away from other appliances.

This prevents noise or image disturbances to the television, etc.

Leave a space around the unit for heat to escape

Leave a space of more than 2 cm to the left and right, and more than 10 cm from the ceiling.
This is to allow heat to escape from the top and sides.

The outside of the unit will get hot.

When you first start running the unit, or in the summer, there may be times when the temperature can go over 50 – 60 °C.

Warning

Do not block the refrigerator's ventilation opening or the spaces around the refrigerator.
If the refrigerant (gas) leaks, it may remain in the area creating the risk of ignition or an explosion.

2 Turning on the power / installing an earth wire

To get the refrigerator cooled down faster, plug it in right after installing.

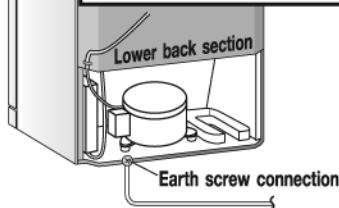

Use a dedicated outlet for the power supply that meets the rating specified on the rating label.
(The rating label is located on the door-liner of the refrigerator compartment.)

To prevent electric shock, installing an earth wire is recommended.

Install an earth wire or an earth leakage circuit breaker, especially when installing takes place where there is a lot of dampness (wooden floor, washing room, basement, etc.).

If there is an earth terminal.

Connect the earth wire to the earth connection screw (⊕), and attach the earth terminal. Also, for the earth wire (copper wire, diameter 1.6mm), please purchase at the store where you purchased your refrigerator.

If you do not have an earth terminal.

Request one at the store where you purchased your refrigerator and have the earthing done. (D-class earthing/grounding – to be paid for by customer.)

If you are installing in an especially damp area.

Besides the earthing, it is required that you have an earth leakage circuit breaker installed. Please consult with the store where you purchased your unit.

Where connections are forbidden.

- Water pipes, gas pipes (due to risk of electric shock, explosion.)
- Telephone lines or a lightning rod earth (dangerous if lightning strikes.)

3 Making adjustments and Affixing

Turn in the direction of the arrows and lower the adjustable legs to place on the floor.

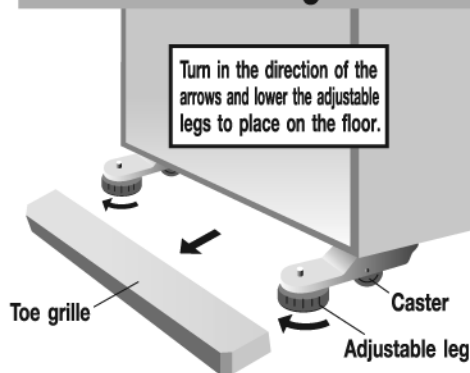

※ The adjustable legs covers are packed in together with the refrigerator for shipping.

Turn the adjustable legs to get them to touch the floor and let the front casters up, then affix.

Prevents vibration, noise, movement and the partial opening of doors.

Caution

If it is not done properly, the refrigerator may move and cause injury.

- Make sure the left and right sides are level, and keep the front at a slightly higher angle. This makes closing the door easier and prevents the door from partially opening.

When the tilt cannot be corrected with the adjustable legs.

If installed in a corner of a room, there are times when one side of the back legs sinks into the floor. When that happens, please make adjustments in the back with casters (to be purchased) or lay a strong board underneath. (Normally, the thickness of the board should be 2 - 3 mm.) For casters, please inquire at the store where you purchased your unit. Model No.: MRPR-03CS

About the direction of the door.

If the installation space is not level, or if after a few days, the weight of the food causes the leg to sink, the door will look like it is sagging. (There are times that the weight of food stored in the refrigerator exceeds 100 kilograms.) Please adjust the adjustable legs by turning them in the direction indicated in the diagram.

If the left side of the door is sagging

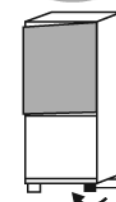

Right

Raise the right side

If the right side of the door is sagging

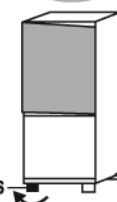

Left

Raise the left side

4 For Earthquake Preparation

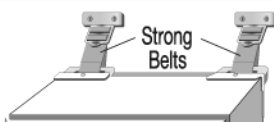

Attach the strong belts in the upper back area (2 belts) and affix them to a sturdy place such as a wall or column.

Warning

The refrigerator can topple over and cause injuries.

For Tottle Prevention Belts (to be purchased) for your refrigerator, please inquire at the store in which you purchased your unit. Model No. MRPR-02BL

How to adjust the temperature.

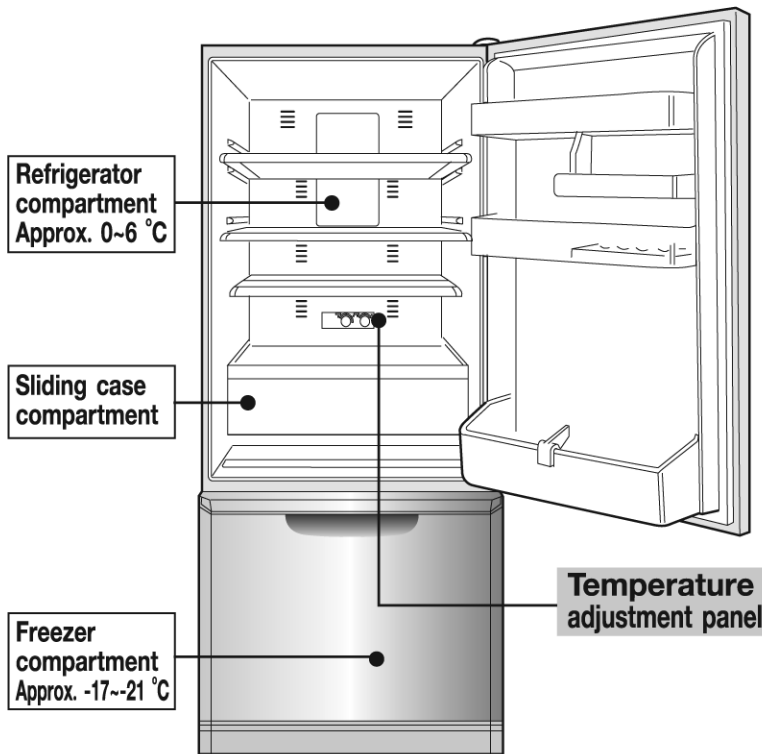

※ Illustration of the MR-BF325B

※ For the temperatures indicated, the freezer and refrigerator compartments were adjusted at the "Normal" position, with an ambient temperature of 30 °C, with refrigerator doors closed and containing no food; after the temperature stabilized, the temperature criteria was measured toward the lower-mid interior of the refrigerator.

Please follow these tips

To cool the unit quickly

Since it takes time to cool down, please insert the electrical plug as soon as possible. It normally takes about 4 - 5 hours to cool down. If you insert the electrical plug immediately after installation, it will not cause damage to your unit.

- When inserting food, make sure to allow some space between items.
- Put in warm food items or ice cream after the refrigerator has been adequately cooled down.
- Keep opening and closing of the door to a minimum, and keep it open for only a short time.

In the summer time when it's hot, it will take approx. 24 hours to make the first batch of ice.

About Non-Freon Refrigerators

Do not damage the refrigerant circuit (piping) and do not drive in screws.

Non-freon refrigerant (gas) has the possibility of igniting, but since the refrigerant circuit is tightly sealed, normally, it will not leak out.

⚠ Warning

If there is damage to the refrigerant circuit:

1. Avoid the use of any flame or electrical appliances.
2. Open the window and ventilate the room well.

After that, please contact the store where you purchased the refrigerator.

About the Door Alarm

The number of times that the door alarm (beeping sound) sounds indicates the following situation.

Sounds off 4 times ※ Indicates that either the refrigerator or freezer door is open. Please close the door.

- ※ Each time the door is open for over 1 minute, the alarm will sound 4 times. If open for over 5 minutes, it will sound continually. Make sure that there is no food caught on the door (on the seal strip/behind the case).
- Please check for this once a month.
 - Please consult the store where you purchased your unit if the alarm sounds on even after the door is closed.

Usually set at "MID" setting

If it's too cold
Gets 2~3 °C higher than "MID"

If you want it colder
Gets 2~3 °C lower than "MID"

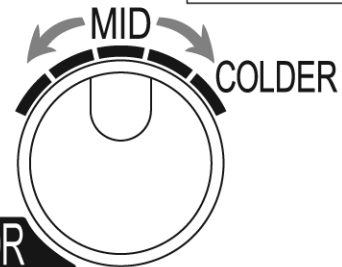

REFRIGERATOR

- Slide compartment and vegetable compartment temperatures will change with temperature adjustments made to the refrigerator compartment.

Usually set at "MID" setting

If it's too cold
Gets 2~3 °C higher than "MID"

If you want it colder
Gets 2~3 °C lower than "MID"

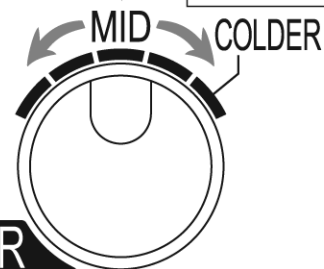

FREEZER

Hints on how to save on electricity.

Electricity-saving tips

- Allow some space between food items.
- Cool down hot foods before placing them in the fridge.
- Keep door openings/closings to a minimum. And, keep the times short.
- When closing the door, do not let food, plastic bags, the electrical cord, etc. get caught in the doorway.

Even if the door is slightly ajar, frost or condensation may form and it will not cool properly. Or, water droplets may form.

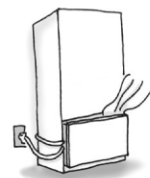

Tips on Storing



Wipe



Wrap

This prevents drying or absorbing of odors.

How to adjust the temperature.

Refrigerator Compartment.

● Refrigerator Compartment.

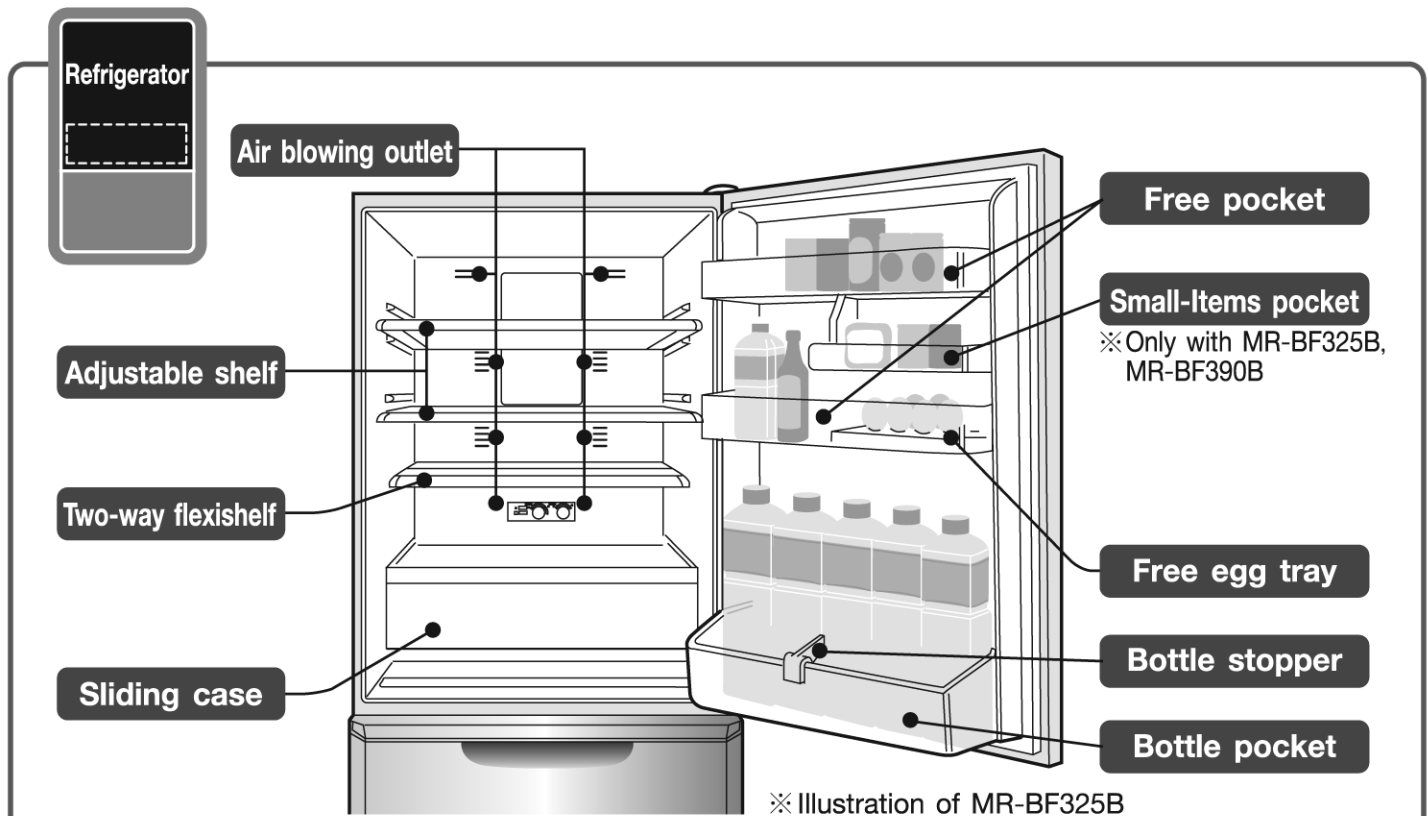

Adjustable shelving

The position of the shelves can be adjusted to boost your storage space!

Pull out the shelves and place them in the position that suits your needs.

Two-way flexishelf

- 1. Make it wider**
- 2. Push it inwards**

Free egg tray

It's an egg case and a small items tray. By turning the egg case upside-down, it converts into a small items tray.

Please follow these tips

Do not let food items protrude beyond the tray
Do not place bottles in the front row of the bottle pocket that are too high for the pocket.

- It can cause the door to be partially open, or it can cause bottles to break.

Do not close the door if food is in front of the sliding case.
Make sure the sliding case is stored away properly.

Do not attach other types of cases sold in stores onto the outer side of the pocket.

- Cooling can get hampered due to a partially open door, food items can fall out causing injuries, or the case can get damaged.
- Do not block the air outlet with other store-bought cases.

Notice

In case your food items get frozen.

- When the ambient temperature is under 5 °C...Adjust the temperature in the refrigerator compartment to "less cold" and this will make the food less likely to freeze.
- For drinks or food items with a lot of moisture...Keep away from sections near the air blowing outlet and place in the front part of the shelf.

Vegetable case and Freezer Compartment.

● Vegetable case and Freezer Compartment.



Sliding case (Vegetable case)

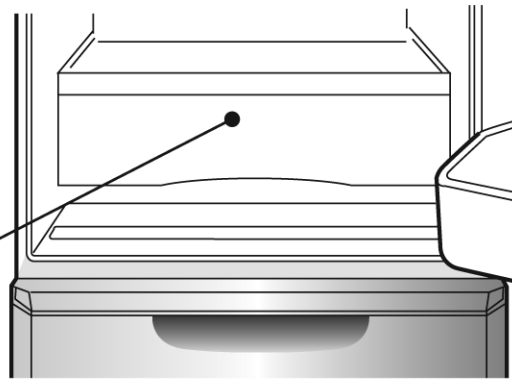

Please take heed

- Do not put tall items in the sliding case.**
- It can damage food items or damage the sliding case.
 - If the sliding case is taken out and used separately, the Vegetable Compartment will become dry.

Notice

- If you wrap fruit and vegetables, they will stay fresh longer.



Ice tray

Ice cube box

Freezing Case (upper)

Freezing Case (lower)

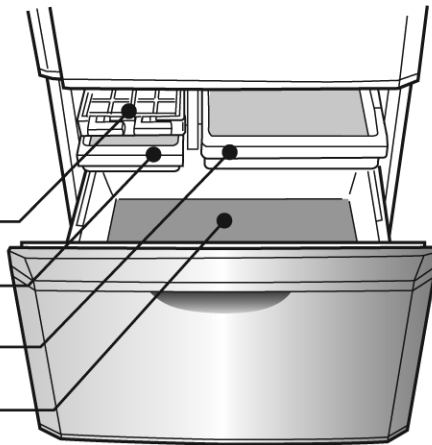

Notice

Put foods in the Freezing Case to below the red line level seen at the front.

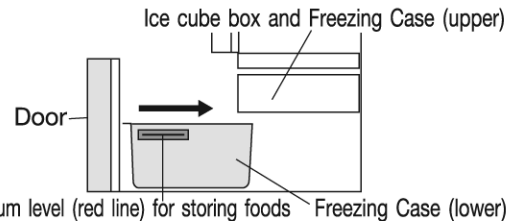

- When closing the door, food can get in the way causing the door not to close properly. This can cause frost to form in the inside, or improper freezing, and will cause a malfunction.
- This may damage food and the Freezing Case, as well as the ice cube box.

Ice making

1. Pour water into each of the sections of the ice tray up to the water line. Insert the tray completely into the ice tray holder. The ice cubes will not separate easily from the ice tray if you add too much water.
2. Once the ice cubes are made, turn the lever until the ice cubes fall into the ice cube storage box.

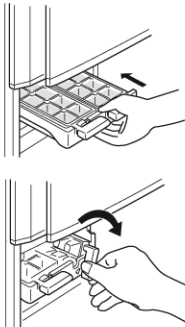

Notice

- The ice cube storage box will break if you attempt to make ice directly in the ice cube storage box.

User tip

- Ice made with water containing a lot of mineral substances such as mineral water, can cause to ice to form with a white sediment (white crystals). These are only mineral substances that have become crystallized. It is harmless.
- If ice is stored for a long period of time, the ice cubes may cling together or become smaller. (This is known as the phenomenon of sublimation.)
- If you're going to break clinging ice cubes apart, be careful that you do not injure your hands.

How to remove and clean accessories.

Before you begin cleaning

Unplug the electrical plug.

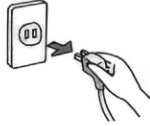

Warning
If it is not unplugged, it will cause an electric shock.

Wait 10 minutes or more before you replug the electrical plug into the outlet. If you plug it in immediately after unplugging it, the refrigerator will not run.

How to clean your accessories

- Wipe with a soft cloth using warm water, or remove part and wash with water.
- For hard-to-remove dirt, first clean using a diluted kitchen detergent (neutral type). Then, finish off with a soft cloth and water. If oily substances remain for some time, the plastic may crack.
- Make sure detergents are wiped off thoroughly.
- If you use a chemical cloth, please be sure to follow the attached instructions.



Please observe the following:

- Do not use alkaline/mild alkaline kitchen detergents, polishing powders, powder detergents, alcohol, benzene, thinner, kerosene, acid, scrub brushes, boiling water, etc. Plastic parts (door handles, caps, cases, etc.) can crack, and it will damage doors and surface paint.

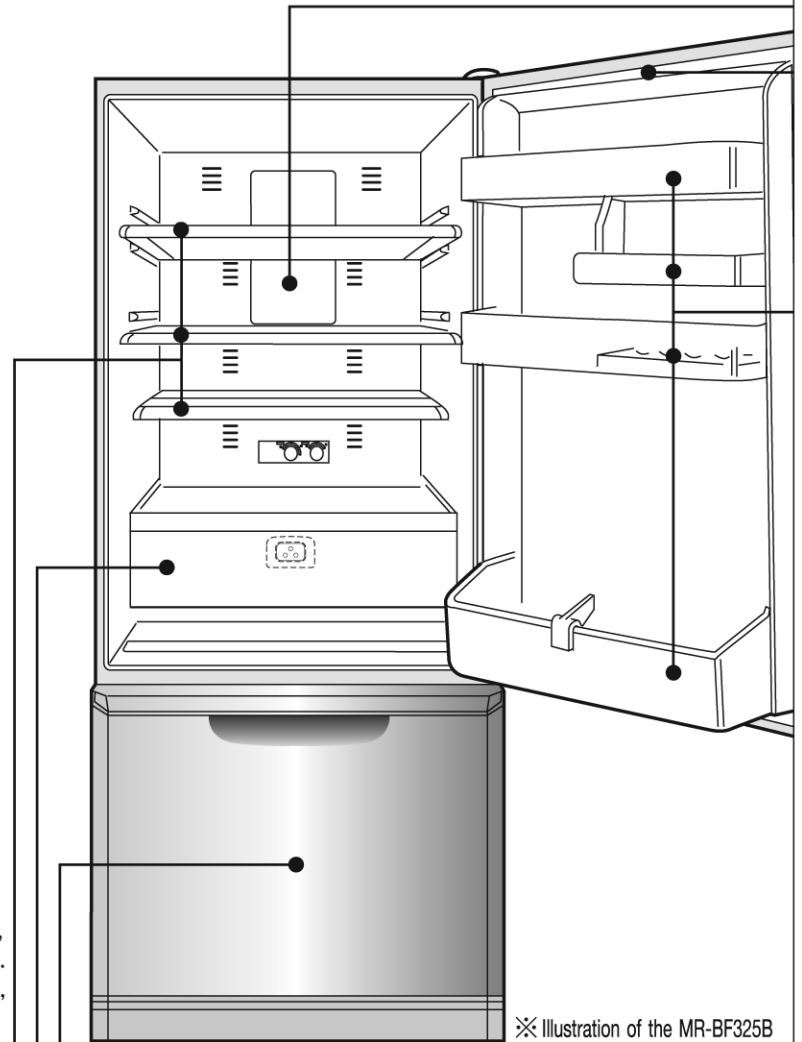

※ Illustration of the MR-BF325B

Refrigerator Compartment

Adjustable shelf

Draw forward, pull downward.



Two-way flexishelf

Draw forward, pull downward.

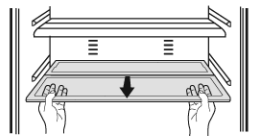

Sliding Case

Lift the front part and draw out.

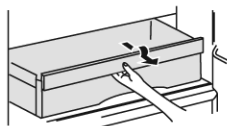

Liquid-Catching Indentations

Wipe away any dirt, liquid or condensation.

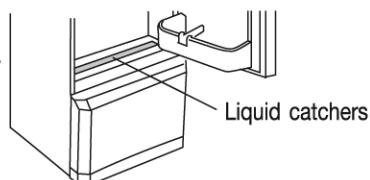

Freezer Compartment

- ① Open the drawer-door
- ② Lift up the ice tray and take out.
- ③ Lift up the freezing case (upper) and ice cube box towards you.
- ④ Take out the freezing case (upper), and while slightly lifting up the door draw out and tilt downwards.
- ⑤ Lift up the freezing case (lower) towards you.

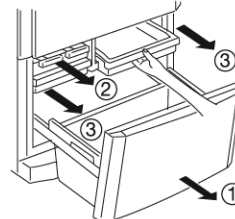

The back of the refrigerator, and on the floor

- ① Turn the adjustable legs, let it rise above the floor, then move the refrigerator.
- ② Wipe the dirt off the back of the unit, the wall, and the floor. Dust can collect at the back side of the unit and on the floor because of the convection air flow, and it's an area that can easily get sooty dirt.
- ③ Check to make sure there's no water leaking on the floor.

Soot and dust

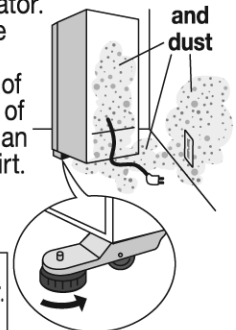

Warning

Do not put your hands or feet under the refrigerator. Doing so may cause injury.

Use reverse procedures to put accessories back in place.

The door seal strip

If the door seal strip gets dirty, it can be easily damaged and can cause cold air to escape.



Free Pockets/Bottle Pockets/Small Items Pocket

- ① Lift upwards holding right and left sides and (the piece is attached quite firmly).
- ② Then draw forwards to remove.
- ③ Make sure that that it is put back on properly.
(If these accessories are not put back properly, they may fall off and cause injury.)

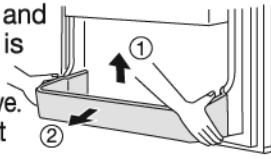

How to change your refrigerator light bulb

- ① Unplug the electrical plug.
- ② Remove adjustable shelves, Two-way flexishelf.
- ③ While pushing up the tabs at the ▲ mark, pull out.
- ④ Change the inside light bulb.
● Purchase a 240V 15W glass light bulb (metal cap E-12) from your refrigerator retailer.
- ⑤ After inserting the upper tabs, set in the lower tabs.

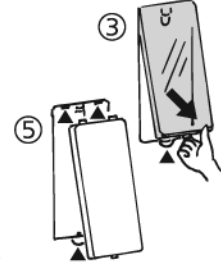

⚠ Warning

If the specified refrigerator bulb is not used, it may cause a fire. Always unplug your refrigerator when changing the light bulb. If you work without unplugging the unit, there is the risk of electric shock or injury. Also, in the worst case, if the refrigerant (gas) is leaking, there may be the risk of ignition or explosion.

After cleaning accessories, inspect at regular intervals

Inspect your electrical plug and cord

- ① Unplug the electrical plug from the outlet and inspect.
Is there any damage or abnormal heat coming from the plug or cord?
- ② Wipe away dust from the plug and around the plug area with a dry cloth.
- ③ Insert the electrical plug fully into the outlet.



⚠ Warning

If dust collects on the electrical plug or cord, it can get damaged and can cause a fire.

What to do in these situations

◆ When there's a power failure.

- Minimize opening/closing of doors and avoid putting in more food.

◆ When not in use for a long time.

- Clean the interior after unplugging the refrigerator, and keep the door open for 2 - 3 days to let it get dry.
※ If not allowed to dry properly, mold and odors can occur, or refrigerant (gas) may leak due to corrosion of the cooling unit.

◆ When transporting.

1. Use protective gear (protective gloves).
2. Lay towels under the water discharge outlet and under the back corners of the refrigerator, and place a container or tray on the floor that's about 3 cms high to catch water.
※ Towels prevent water from spilling on the floor and damage to the floor.
3. Slowly tilt the refrigerator back to an angle of over 30 degrees, discharge water of the evaporator tray through the water discharge outlet (the evaporator tray is not visible from the outside.)
※ Have 2 or more persons do this work because the unit is heavy.
※ Avoid having young children or those without confidence do this work.
Please seek advice from a moving company.
4. With more than 2 persons, calmly and slowly transport the unit by grasping the front side's lower section inner edge and the back side's upper section handle.
● Do not lay or load on its side (it will cause damage to the compressor.)
● If you are moving, it won't be necessary to convert the electrical power frequency. (Can use 50 or 60Hz).

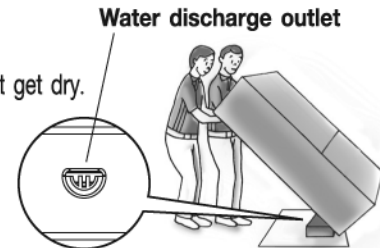

◆ When moving the unit / when changing the direction of the unit.

1. Lift the adjustable legs. **Page 4**
2. Move in a forward or backward direction. ● If moved other than a in forward or backward direction, there's a risk of damaging the floor.
3. When changing the direction of the unit, please use caster wheels or place a protective cloth under the back legs.





⚠ Warning

Do not damage the refrigerant circuit, do not drive in screws, etc.

The unit uses a flammable refrigerant, so if the gas leaks out, there is the risk of ignition or an explosion.

If you think “is this a problem?”

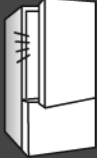
Please check the following points. If the problem cannot be solved, immediately contact the store where you bought the unit.

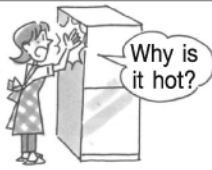
| If this happens... | Please check this out. | Please do this. This is the reason. |
|--|---|---|
| It doesn't cool at all. | ① Is it getting electrical power? | ① Please check the electrical plug and breaker. |
| It doesn't cool properly It only makes small amounts of ice The ice is melting.  | ① Is the temperature adjustment set on a left of “MID?” ② Is it right after installing the unit? ③ Is there not enough space around the unit, is the sun directly on it, or is the radiation of heat being blocked? ④ Is the flow of cold air being blocked? Are doors being opened often, or are doors improperly sealed shut? | ① Please adjust the temperature to “MID” or “COLDER.” ② It will take about 4~5 hours to cool down. During summer, it may take about 24 hours to make ice. ③ Please check to see that it's installed properly. Page 4 ④ Please check to see that too much food isn't placed in the refrigerator and that the door is properly sealed shut. Page 5 |
| Foods get frozen in compartments besides the freezer.  | ① Is the refrigerator compartment temperature set at “COLDER” or “CHILLED?” ② Are foods with a lot of moisture placed at the back end of the shelf? ③ Is the ambient temperature less than 5 °C? | ① Please adjust the refrigerator compartment temperature to “MID.” ② Please put foods such as tofu, vegetables, fruit, and foods with a lot of moisture or drinks towards the front part. ③ If the freezer compartment temperature is adjusted to a left of “MID”, foods will be less likely to freeze. |
| Dew forms on the outside/ inside of the fridge Frost forms in the freezer compartment. Water drips on the floor.  | ① Are the doors being opened often? Are doors improperly sealed shut? ② Is it a time of high humidity as in the rainy season? | ① When the moisture in the air gets cooled, frost or dew forms. Even if the door is just slightly open, frost or dew may form. Also, this dew may sometimes drip onto the floor. Page 5 ② There may be times when dew forms temporarily. Please wipe it off with a dry cloth. Also, there may be times when frost forms in the freezer compartment. Please open the door for shorter times. |
| Doors open easily Doors don't close.  | ① Is food or a case blocking the door? ② Is there food caught at the back of the case of a drawer-door? Is the electrical cord caught between the body of the unit and the door? ③ Does the refrigerator wobble or seem unstable? Are the adjustable legs touching the floor? | ① Put away items properly so that they don't interfere when closing the door. ② Remove the item. Please do not let food items, the electrical cord, plastic bags, etc. get in the way. ③ Bring the adjustable leg down, and raise the front higher, with a slightly raised front, closing doors becomes easier. Page 4 |
| The odor bothers me (Food items / ice). | ① Have you put in strong-smelling foods without using a food wrap? ② Is the water supply tank unclean? | ① If the smell is strong, the odor-removing device cannot remove it all, so please wrap such items. ② Please do a regular cleaning maintenance. |
| I get static noise from the TV, etc. | ① Is the refrigerator installed near a TV? ② Is the power source for the refrigerator taken from near the antenna cable inlet? | ① Please set your refrigerator at a distance from TVs, etc. ② We recommend a single power outlet and that earthing is done. |
| It's got a loud sound It's got sounds that worry me The following sounds do not mean there's a problem.  | ① The sound suddenly gets louder. The sound changes. ② There's a “phyoon” sound when I close the door. ③ Sometimes there are sounds like “shuu” or “plub-plub” (boiling water sound) or “shaaa”(water flowing sound). ④ When I open the door, there's sometimes a “krik” sound coming from the inside, or a sound like water running. ⑤ Sometimes there's a “bzzzt” sound like a flying mosquito. | ① If it is right after installation, or hot out, or if doors are open/closed often, it goes into high-speed operation to chill with greater power. ② This is the sound of the fan motor starting up. ③ This is the sound of refrigerant (gas) flowing through. ④ This creaking sound occurs when warm air enters and the plastic expands. ⑤ This is the sound of the damper working to adjust the air flow. |
| The outside of the unit gets hot There's air coming from the floor. |  | This is because there's heat radiating from the sides and top of the refrigerator, there's dew prevention piping and there's a fan below expelling radiating heat. Right after installation or during the summer, especially if it's hot outside (about 50-60 °C), warm air can come out from under the unit. This operation is necessary to keep the unit cool and there is no problem. |

● If you think “is this a problem?”

Accessories.

| | Model name | MR-BF290B | MR-BF325B | MR-BF390B |
|--------------------------|-------------------------------|-----------|-----------|-----------|
| | Accessories | Quantity | Quantity | Quantity |
| Refrigerator compartment | Adjustable shelf | 2 | 3 | 4 |
| | Two-way flexishelf | 1 | 1 | 1 |
| | Sliding case (vegetable case) | 1 | 1 | 1 |
| | Free pocket | 2 | 2 | 2 |
| | Free egg tray | 1 | 1 | 1 |
| | Small-Item pocket | - | 1 | 1 |
| | Bottle pocket | 1 | 1 | 2 |
| | Bottle stopper | 1 | 1 | 1 |
| Freezer compartment | Ice tray | 2 | 2 | 2 |
| | Ice cube box | 1 | 1 | 1 |
| | Freezing case (upper) | 1 | 1 | 1 |
| | Freezing case (lower) | 1 | 1 | 1 |
| | Toe grille | 1 | 1 | 1 |

■ This appliance is designed for use in Australia and New Zealand only and cannot be used in any other country. No service is available outside of Australia and New Zealand."

When you hear noise from the lower rear of the refrigerator

- As part of the cooling system is a compressor that, when it operates, does make a more noticeable increase in noise level. This is normal. However, if the noise is quite loud, this could be because the refrigerator is not installed correctly on a hard level surface, or there may be a problem that may need service.

| MODEL NAME | COUNTRY NAME |
|------------------------|--------------|
| MR-BF290B/325B/390B-A | AUSTRALIA |
| MR-BF290B/325B/390B-NZ | NEW ZEALAND |
| | |

CAUTION

1. This appliance is designed for use in ambient temperature listed below.

| MODEL NAME | AMBIENT TEMPERATURE RANGE | CLIMATIC CLASS |
|------------------------------|---------------------------|----------------|
| MR-BF290B, BF325B, BF390B-A | 16 °C ~ 43 °C | T |
| MR-BF290B, BF325B, BF390B-NZ | 16 °C ~ 43 °C | T |
| | | |

The internal temperatures could be affected by such factors as the location of the refrigerating appliance, ambient temperature and the frequency of door opening, and, if appropriate, a warning that the setting of any temperature control device might have to be varied to allow for these factors.

2. A rise in temperature of the frozen food during manual defrosting, maintenance or cleaning could shorten the storage life.
3. Food to be frozen is not to be placed in direct contact with food in storage and, if appropriate, that it could be necessary to reduce the quantity to be frozen if freezing every day is anticipated.
4. The electrical power failure for 1-2 hour will only slightly effect the inside temperature. However, open & close of the door results in the temperature loss. In case there is more than 24 hours electrical power failure, the food should be taken out from the fridge.
5. In case you are leaving or there is no food in the fridge for more than 3 weeks, The fridge should be unplugged and cleaned.



HEAD OFFICE : TOKYO BUILDING 2-7-3, MARUNOUCHI, CHIYODA-KU, TOKYO 100-8310, JAPAN
PHONE: +81 (3) 3218-2111
<http://Global.MitsubishiElectric.com>

Distributed by:

MITSUBISHI ELECTRIC AUSTRALIA PTY LTD.

(Incorporated in New South Wales) ABN 58 001 215 792

New South Wales:

348 Victoria Road, Rydalmere 2116 Ph: (02) 9684 7777, Fax: (02) 9898 0484

Queensland:

Unit 12, 469 Nudgee Road. Hendra QLD 4011 Ph: (07) 3623 2000, Fax: (07) 3630 1888

South Australia / Northern Territory:

77 Port Road, Hindmarsh 5007 Ph: (08) 8340 2000, Fax: (08) 8340 0555

Western Australia:

Unit 5, 329 Collier Road, Bassendean 6054 Ph: (08) 9377 3400, Fax: (08) 9377 3499

Victoria / Tasmania:

Suite 28, 270 Ferntree Gully Road, Notting Hill VIC 3168 Ph: (03) 9535 7800, Fax: (03) 9535 7801

Distributed by:

BLACK DIAMOND TECHNOLOGIES LIMITED (BDT)

Wellington Office (Head Office)

1 Parliament Street PO Box 30-772 Lower Hutt Ph: (04) 560 9100, Fax: (04) 560 9133

Auckland Office

Unit 1, 4 Walls Road Penrose Auckland PO Box 12-726 Ph: (09) 526 9340, Fax: (09) 526 9369

Christchurch Office

Suite 2, Level 1, 37 Manderville Street Christchurch PO Box 1604 Ph: (03) 341 7052, Fax: (03) 341 7054