

mitsubishi
Refrigerator-Freezers



OPERATING INSTRUCTIONS

SERIES MODEL MR-260B

1. Components

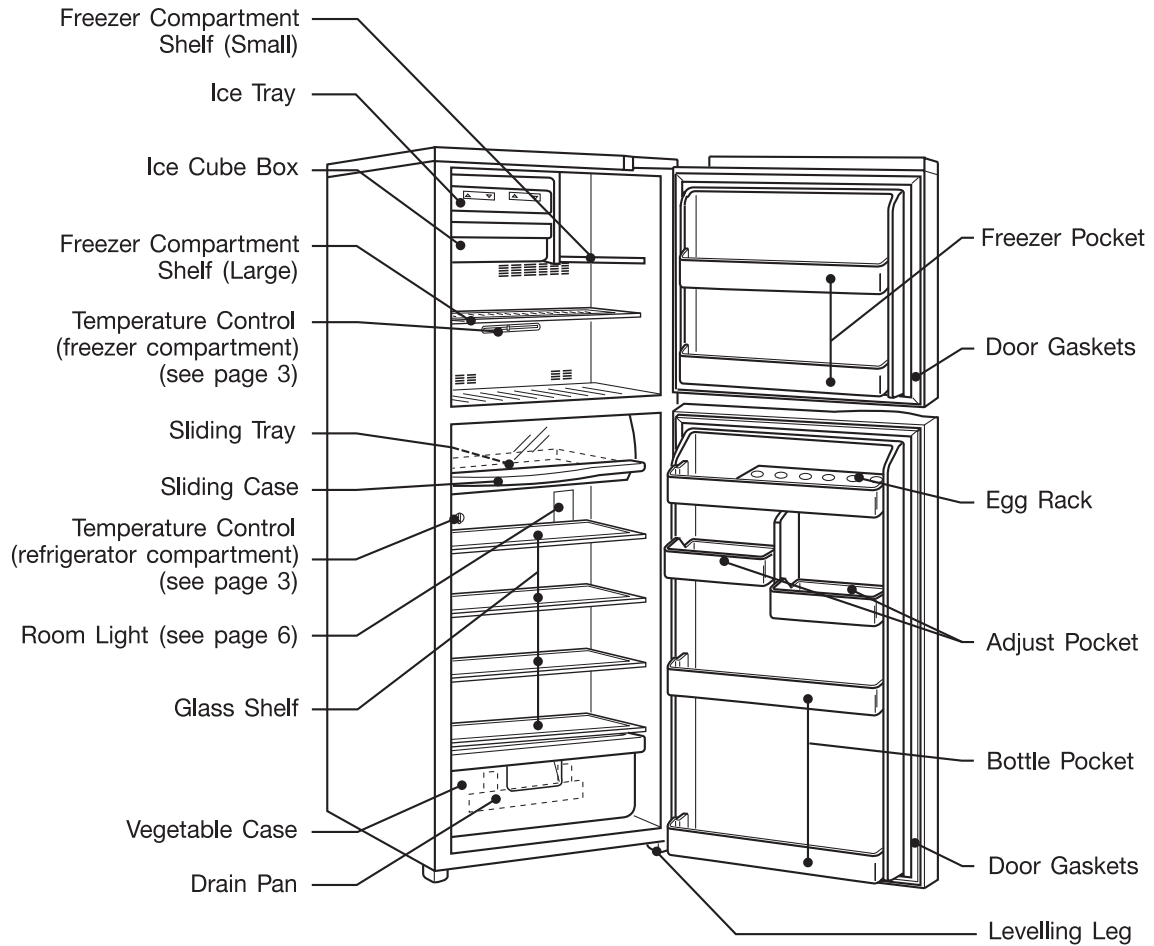

This illustration shows series models MR-260B

2. Installation

- Install on a completely flat and rigid surface.
- Level the refrigerator by rotating the levelling leg located in the front of the right corner.
The refrigerator is then solidly positioned.
- Leave a 2-cm space between the sides of the refrigerator.
Leave a 10-cm space between the top of the refrigerator and the ceiling.
Leave a 5-cm space between the back of the refrigerator.
- Choose a location which is not exposed to the sun, which is relatively free from dust, heat and humidity, and which offers good ventilation. This is to guarantee that the heat radiation will not be impaired.

How to remove the energy label

- Remove the energy label carefully. A glue residue may remain, particularly if the label has been in place for a long period of time.
 - Apply either Eucalyptus or Tea Tree oil directly on any residue.
 - Do not allow the oil to run or drip onto plastic parts as it may cause the plastic to degrade and potentially crack over time.
 - Allow the oil to sit for approximately 1-2 minutes, or until the glue residue has softened.
 - Wipe off with a damp cloth.
 - If any residue remains, repeat the above process.
 - Rinse with clear water.
 - Dry thoroughly.
-

3. Electrical Connections

Important: For personal safety, this appliance must be properly grounded.

- The refrigerator should always be plugged into its own individual electrical outlet.
This is recommended for best performance and also in order to prevent the overloading of household wiring circuits, which may cause a fire hazard. Extension cords are not recommended.
Make sure that the outlet provides the correct voltage.
 - If your refrigerator has a grounding plug, use it correctly. The 3-point plug must be inserted into a mating 3-point grounded receptacle. If the installation location does not have a proper 3-point grounding wall receptacle, the proper type must be installed. The ground point should never be cut or removed.
 - If your refrigerator has an ungrounding plug, connect the ground wire to the ground connection screw provided at the lower rear side of the refrigerator.
-

4. Operation

1. Temperature control

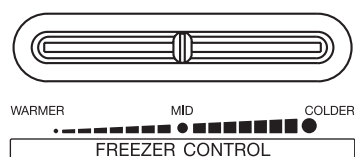

(A)

MR-260B

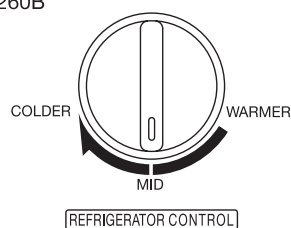

(B)

The freezer and refrigerator controls are inter-linked. To change the temperature in the freezer for example, the freezer (A) and refrigerator (B) controls must be adjusted.

- For normal coldness in both compartments, set (A) to "MID" and set (B) to "MID".
- For maximum coldness in both compartments, (A) remains at "MID" and set (B) to "COLDER".
- For the freezer to be colder than normal, set (A) to "COLDER" and (B) to "COLDER".
- For the refrigerator to be colder than normal, set (A) to "WARMER" and (B) to "COLDER".

2. Automatic Defrosting

Thanks to the built-in automatic defrosting timer and heater, this refrigerator performs defrosting automatically, so there is no need to defrost it manually. Water produced during defrosting passes through the drainage hose at the rear and collects in the drain pan in the lower rear part of the refrigerator. Then, it automatically evaporates with heat from the radiator.

3. Ice-making

- Pour water up to the water line in each of the ice tray sections. Insert the tray completely into the ice tray holder.
- Once the ice cubes have been made, turn the lever until they fall into the ice cube storage box.
- If you attempt to make ice directly in the ice cube storage box, the box will break.



4. Sliding Case

- This sliding case is cooled to a low temperature in order to preserve the freshness of foods stored for long periods.

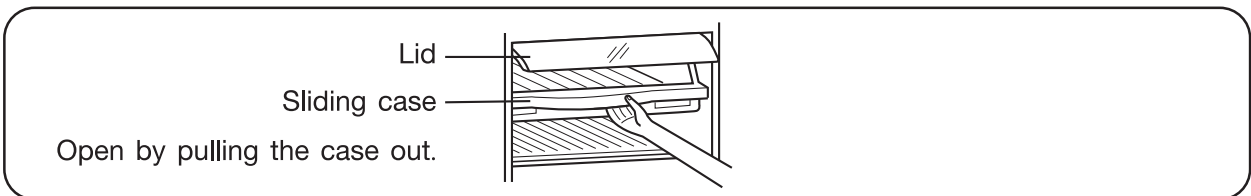

CAUTION:

Before closing the refrigerator compartment door, make sure that the sliding case is pushed all the way in (and the lid is closed correctly).

- Remove the lid and sliding case as shown in the illustration and proceed with cleaning.
- Pull the case out. Open the lid and then pull out holding the right and left hand sides (Fig. 1).
- Pull the case out all the way. Pull out by holding and lifting the edge of the case upwards (Fig. 2).

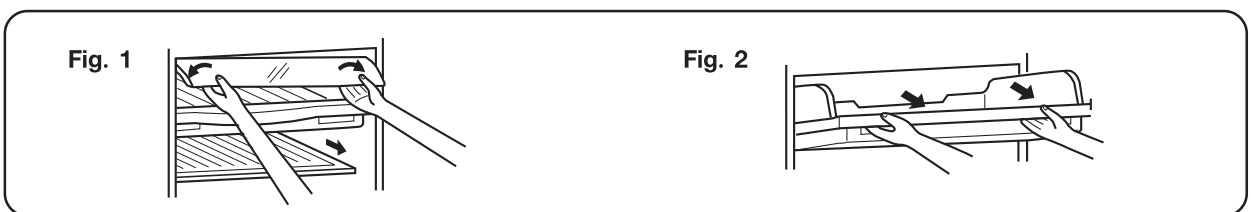

- Lift the sliding tray up using the projection at the center rear of the tray.
- When placing the sliding tray inside the sliding case, insert it into the front side of the case first. The tray will disturb airflow if inserted into the rear side of the case first.

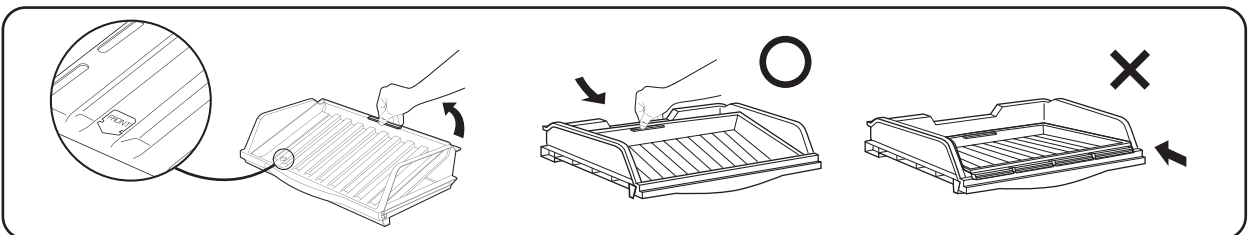

5. Door Racks

The door racks may be used to store all those little items that seem to get in the way. If you put all the small items in one place, you'll find that there's more space inside the refrigerator for larger items.

Free Pocket with Egg Tray

- Many eggs may be stored in the free pocket (Fig.1).
- You can even turn the whole egg tray over and store small items in the free pocket instead of eggs (Fig.2).

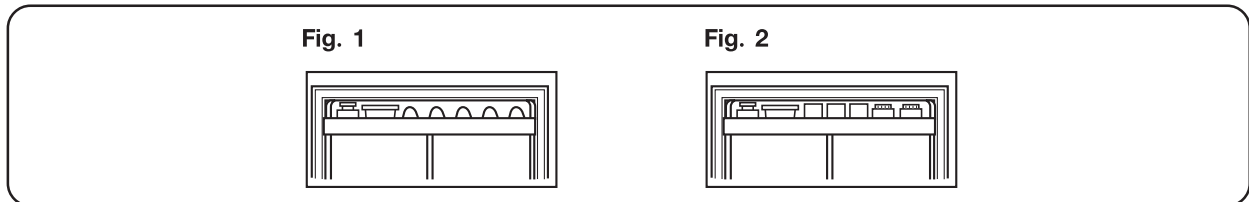

Bottle Pocket

- Space for large bottles is provided on the right.
- Bottles are stored at an angle for easy access.

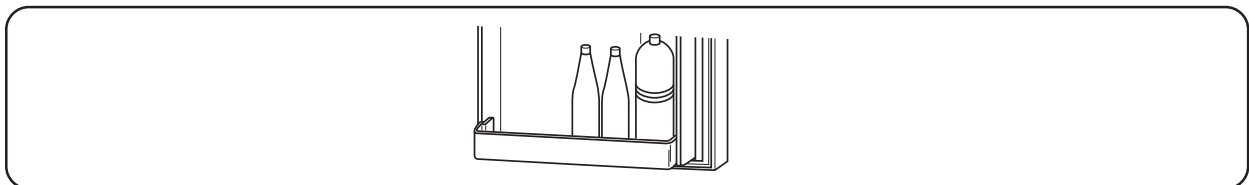

Some types of commercial water cooler bottles may touch the shelf or foodstuffs when placed in the door pocket, preventing the door from closing firmly.

Adjustable Pocket

- The adjustable pocket may be adapted to the food stored in the pocket.
- Large containers such as beer bottles may be accommodated in the upper bottle pocket if the adjustable pocket is installed in the upper position.

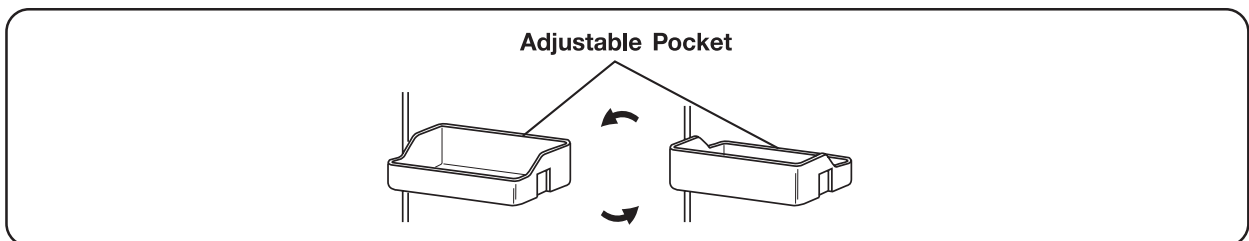

6. How to Remove the Pockets

- Remove the door racks as shown in the illustration in order to proceed with cleaning.
- This pocket may be removed by pushing it gently upwards.

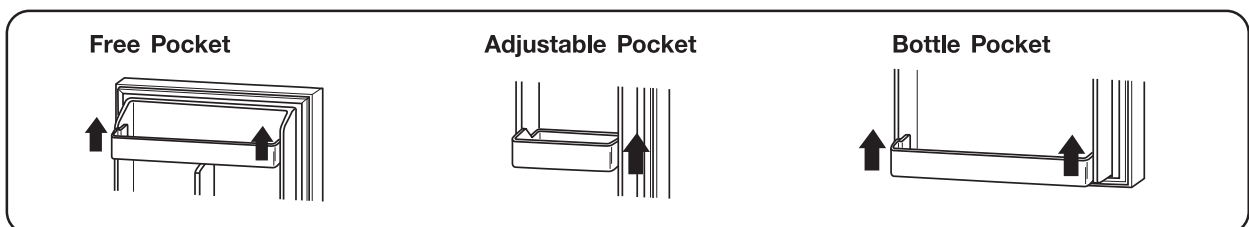

5. Maintenance

When performing maintenance, make absolutely sure that the power plug is first disconnected from the power outlet.

- Dip a soft cloth into cold or lukewarm water, wring it out well and wipe.
- If you do not clean the door gasket (especially the lower part) when it is dirty, the gasket will easily become damaged. Therefore, keep it clean at all times.
- Do not clean with cleanser, acids, benzine, thinner, boiling water, soap powder, chemical cloths or neutral detergent. These will damage the paint finish and external surfaces of your refrigerator.

CAUTION

Do not apply water directly onto the refrigerator.
This may result in malfunction, power leakage or fire.

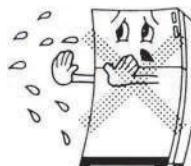

- The drain pan becomes dirty very easily and if not cleaned regularly, produces bad odours. Get into the habit of cleaning this pan regularly.

1. How to Remove the Drain Pan

- Disconnect power plug from the power outlet.
- Pull the refrigerator away from the walls.
- Remove the drain pan as shown.
- When removing the drain pan, pull up on the drain pan at a slight angle so it does not contact the drainpipe.
- To install, insert the drain pan completely so the drainpipe is located above the drain pan.
(Failure to insert the drain pan completely can lead to water leaks, noise, and vibration.)

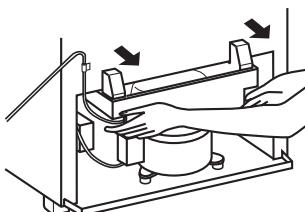

2. How to Replace the Room Light

Important: Unplug the power cord. Failure to do so may cause electric shock.

- To remove the room light cover, pull it towards you by pressing the lower convex part upwards.
- Remove the room light located to the right of the temperature control inside the refrigerator compartment. Purchase a 240V/15W (capE-12) room light.

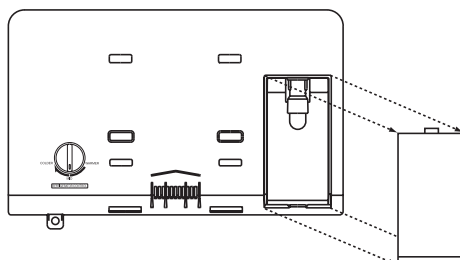

6. Safety Advice

The suggestions below apply to the operation of your home electric refrigerator. Mitsubishi Electric Corporation recommends these safety precautions.

- If your old refrigerator is still in your house but not in use, be sure to remove the door(s). This will ensure that children will not get trapped inside.
- Never unplug your refrigerator by pulling on the cord. Always take hold of the plug firmly and pull it straight out of the socket.
- Do not operate your refrigerator in the presence of explosive fumes.
- Fizzy drinks should not be frozen.
- Avoid immediate consumption of ice lollies and other similar frozen food items.
- If the power cord is damaged, call our Mitsubishi Service Center for a replacement in order to avoid a safety hazard.
- Keep ventilation openings in the appliance enclosure and the built-in structure clear of obstruction.
- Do not use mechanical devices or other means to accelerate the defrosting process.
- Do not use electrical appliances inside the food storage compartments of the refrigerator unless they are recommended by the manufacturer.
- This appliance is not intended for use by young children or infirm persons unless they have been adequately supervised by a responsible person to ensure that they can use the appliance safely.
- Young children should be supervised to ensure that they do not play with the appliance.
- Do not damage the refrigerant circuit.
- This refrigerator uses flammable foaming gas for insulation.
- Please deliver the unit to a specialized industrial recycler / dealer for disposal.
- Please follow applicable disposal regulations in your country.
- This appliance is not intended for use by persons (including children) with reduced physical, sensory or mental capabilities, or lack of experience and knowledge, unless they have been given supervision or instruction concerning use of the appliance by a person responsible for their safety. Children should be supervised to ensure that they do not play with the appliance.

7. Troubleshooting

When the refrigerator fails to operate

- Check for a power failure.
- Check if the power cord is plugged into the power outlet.
- Check that the fuse (or circuit-breaker) has not blown.

When the refrigerator is cooling excessively

- The temperature control dial may be set too high.
- If you place foodstuffs containing a lot of moisture directly under the cool air outlets, they will freeze easily. This does not indicate a malfunction.

When you hear a sound similar to flowing water

- The sound of flowing water is the flow of refrigerant (cooling gas). This does not indicate a malfunction.

When noise is produced by the fan grill of the refrigerator

- The noise produced by the fan grill will stop at a certain fixed temperature. The airflow cooling system inside the refrigerator is powered by the operation of the fan motor and fan grill.

When noise is produced while the refrigerator door is open

- When you open a door panel, plastic components switch swiftly between hot and cold, and this may produce noise. When the door is closed, the noise will remain until the difference in temperature is reduced.

When the refrigerator is not cooling sufficiently

- The food may be packed too tightly together, which blocks the flow of cool air.
- You may have put hot or too many items into the refrigerator.
- The door may not have been closed properly.
- The door gasket may be damaged.
- The refrigerator may not be well-ventilated.
- There may be insufficient clearance between the refrigerator and the surfaces immediately beside and above.
- The temperature control dial may not be properly set.

When the front of the refrigerator cabinet heats up

- In order to safeguard against condensation, there is an anti-condensation pipe which heats up the front of the cabinet when actuated. When the front of the cabinet is warm, this does not indicate a malfunction. The more often the door is opened and closed, the more often the anti-condensation pipe is actuated. It is also actuated immediately after the refrigerator has been installed. In other words, the front of the cabinet often heats up.

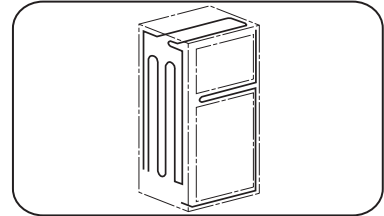

When condensation forms on the exterior of the refrigerator

- Condensation may form on the exterior when humidity is high, such as during the wet season. This is comparable to condensation forming on the outside of a glass when chilled water is poured in; therefore, it does not indicate a failure. Wipe dry with a dry cloth.

When the power plug is disconnected and reconnected, and the compressor ceases to rotate

- When the power plug is disconnected from the power outlet and then immediately plugged in again, the compressor may not restart. Therefore, when unplugging the refrigerator, always wait at least 5 minutes before plugging it in again. If the compressor ceases to rotate completely, keep the refrigerator unplugged and wait at least 5 minutes before plugging it in again.

When the side panel of the cabinet heats up

- The side panel of the cabinet will heat up when the door is opened and closed frequently, when installing the unit and when the unit operates in summer in high temperatures. In such cases, do not touch the panel. This heat buildup is due to the dissipation of heat absorbed from inside the cabinet over the whole of the side panel and does not indicate something wrong with the unit.

CAUTION

1. This appliance is designed for use in ambient temperature listed below.

MODEL NAME	AMBIENT TEMPERATURE RANGE	CLIMATIC CLASS
MR-260B-A	16 °C ~ 43 °C	T
MR-260B-NZ	16 °C ~ 43 °C	T

The internal temperatures could be affected by such factors as the location of the refrigerating appliance, ambient temperature and the frequency of door opening, and, if appropriate, a warning that the setting of any temperature control device might have to be varied to allow for these factors.

2. A rise in temperature of the frozen food during manual defrosting, maintenance or cleaning could shorten the storage life.
3. Food to be frozen is not to be placed in direct contact with food in storage and, if appropriate, that it could be necessary to reduce the quantity to be frozen if freezing every day is anticipated.
4. The electrical power failure for 1-2 hour will only slightly effect the inside temperature. However, open & close of the door results in the temperature loss. In case there is more than 24 hours electrical power failure, the food should be taken out from the fridge.
5. In case you are leaving or there is no food in the fridge for more than 3 weeks, The fridge should be unplugged and cleaned.

8. How to attach and insert vegetable case cover

Attach Vegetable case cover with compartment shelf, During attachment, place left and right corner of Vegetable case cover under compartment shelf and put the edge of Vegetable case cover into the rail, Vegetable case cover should fit into the rail of compartment shelf.

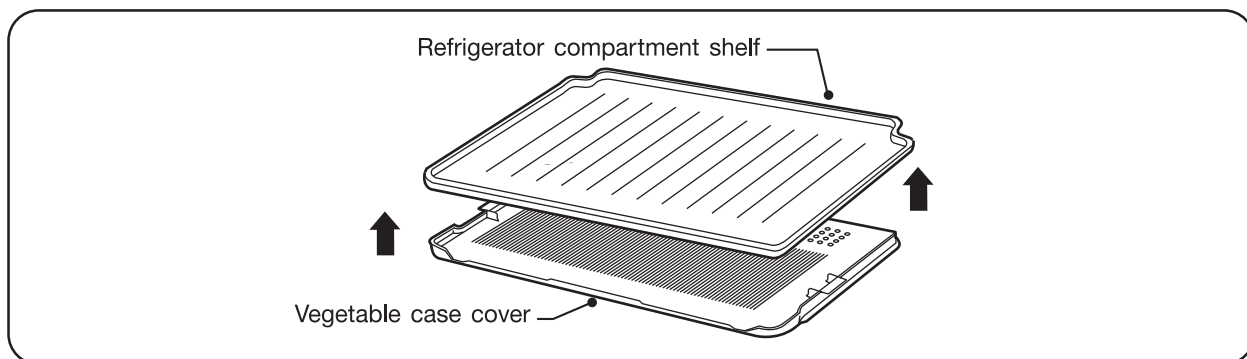

Insert the attached Vegetable case cover and compartment shelf into the rails (both left and right) upon the vegetable case. Then insert the vegetable case.

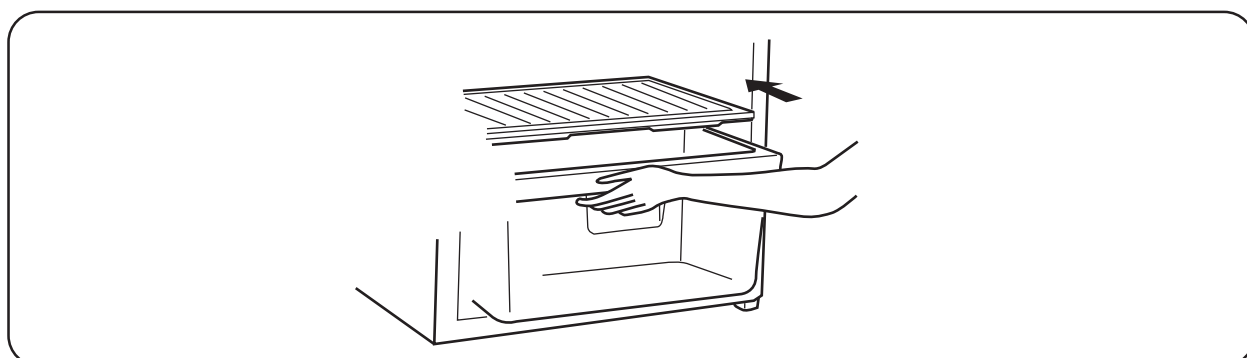



MITSUBISHI ELECTRIC CORPORATION

HEAD OFFICE : TOKYO BUILDING 2-7-3, MARUNOUCHI, CHIYODA-KU, TOKYO 100-8310, JAPAN
PHONE: +81 (3) 3218-2111
<http://Global.MitsubishiElectric.com>

Distributed by:

MITSUBISHI ELECTRIC AUSTRALIA PTY LTD.

(Incorporated in New South Wales) ABN 58 001 215 792

New South Wales:

348 Victoria Road, Rydalmere NSW 2116 Ph: (02) 9684 7777, Fax: (02) 9898 0484

Queensland:

Unit 12, 469 Nudgee Road. Hendra QLD 4011 Ph: (07) 3623 2000, Fax: (07) 3630 1888

South Australia / Northern Territory:

77 Port Road, Hindmarsh SA 5007 Ph: (08) 8340 2000, Fax: (08) 8340 0555

Western Australia:

Unit 5, 329 Collier Road, Bassendean WA 6054 Ph: (08) 9377 3400, Fax: (08) 9377 3499

Victoria / Tasmania:

Suite 28, 270 Ferntree Gully Road, Notting Hill VIC 3168 Ph: (03) 9535 7800, Fax: (03) 9535 7801

Distributed by:

BLACK DIAMOND TECHNOLOGIES LIMITED (BDT)

Wellington Office (Head Office)

1 Parliament Street PO Box 30-772 Lower Hutt Ph: (04) 560 9100, Fax: (04) 560 9133

Auckland Office

Unit 1, 4 Walls Road Penrose Auckland PO Box 12-726 Ph: (09) 526 9340, Fax: (09) 526 9369

Christchurch Office

Suite 2, Level 1, 37 Manderville Street Christchurch PO Box 1604 Ph: (03) 341 7052, Fax: (03) 341 7054

NZ79C185H01