

MITSUBISHI FREEZER

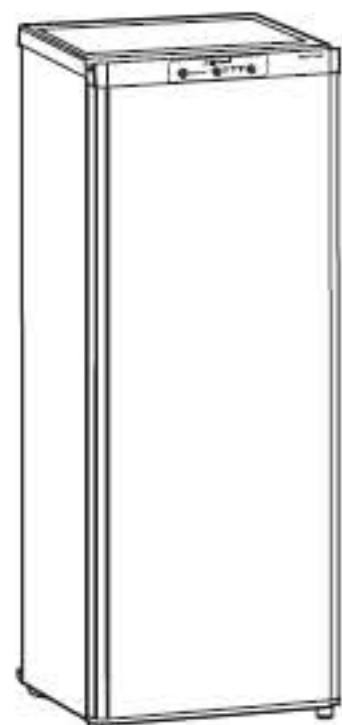

MF-U160B

**OPERATING
INSTRUCTIONS**



Easy Freezer Use

Contents

Before using your freezer

From installation to operation 2

Using

Compartment name and use 3

Smart tips for using your freezer 3

Adjusting the temperature 4

Maintenance and troubleshooting

Maintenance 5

What to do (during blackouts, long periods of non use, and transport) 5

Safety precautions 6

Troubleshooting 7

Specifications 8

- Please read this manual carefully and follow the information contained within. In particular, be sure to read the safety precautions before using this freezer.
- Be sure to receive your copy of the warranty from the retailer and confirm that the purchase date and retailer name are written on the warranty.
- Store this operating instructions manual and the warranty in a safe place.

-
- This freezer was manufactured for freezing of foods in general households. For commercial use, please use a commercial freezer.
 - The principal plastic components indicate the material name to facilitate recycling.

From installation to operation

Installation location

The installation location should be a well-ventilated area out of direct sunlight and not exposed to hot air

to avoid diminished cooling power and to economize on electricity costs.

Low humidity

is recommended to prevent rusting.

Strong and level location

is recommended to prevent vibration and noise.

- If the freezer is installed on flooring on which the freezer supports easily sink (such as carpeting, woven mats, polyvinyl chloride flooring, etc.), place a strong plate or board under the freezer. (This is necessary to prevent deformation or discoloration due to heat.)

Away from other household appliances

is recommended to prevent noise or image interference with televisions, etc.

Leave space for heat ventilation

Leave at least 2 cm of space to the left and right of the freezer and at least 10 cm of space above the freezer

to allow heat to escape from above and to the sides of the freezer.

The exterior of the freezer gets hot

When the freezer is first used and during the summer, the exterior temperature can exceed 50~60 °C.

To ensure quick cooling

■ The freezer will not immediately cool after power is turned on. It normally takes 4~5 hours for the freezer to cool.

- Leave space between food items.
- Allow the freezer to cool sufficiently before you store non-cooled food items or ice cream.
- Open and close the doors only as much as necessary and do not leave them open for long periods of time.

Especially during hot summers, it may take 24 hours to make the first batch of ice.

Adjust supports for level installation

Turn the adjustable supports located at the bottom front of the freezer for level installation

recommended to prevent vibration and noise.

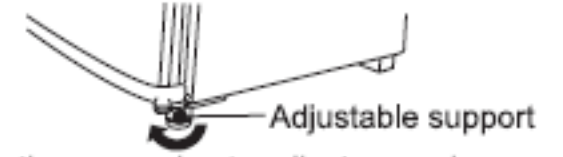

Follow the arrow sign to adjust up or down the level of the appliance by turning the supports located at the bottom.

Do not modify

Warning

Do not screw any attachment, such as a child safety catch, to the top or sides of your freezer.

Doing so may cause malfunctions, shock, fire or explosion and will void your warranty.

Use a dedicated outlet

Use a dedicated outlet for the power supply that meets the rating specified on the rating label. (The rating label is located on the door-liner of the freezer compartment.)

Warning

Using outlets that do not meet the specified rating or plugging in too many leads into a single socket can cause heat build up or fire.

How to remove the energy label

- Remove the energy label carefully. A glue residue may remain, particularly if the label has been in place for a long period of time.
- Apply either Eucalyptus or Tea Tree oil directly on any residue.
- Do not allow the oil to run or drip onto plastic parts as it may cause the plastic to degrade and potentially crack over time.
- Allow the oil to sit for approximately 1-2 minutes, or until the glue residue has softened.
- Wipe off with a damp cloth.
- If any residue remains, repeat the above process.
- Rinse with clear water.
- Dry thoroughly.

Compartment name and use

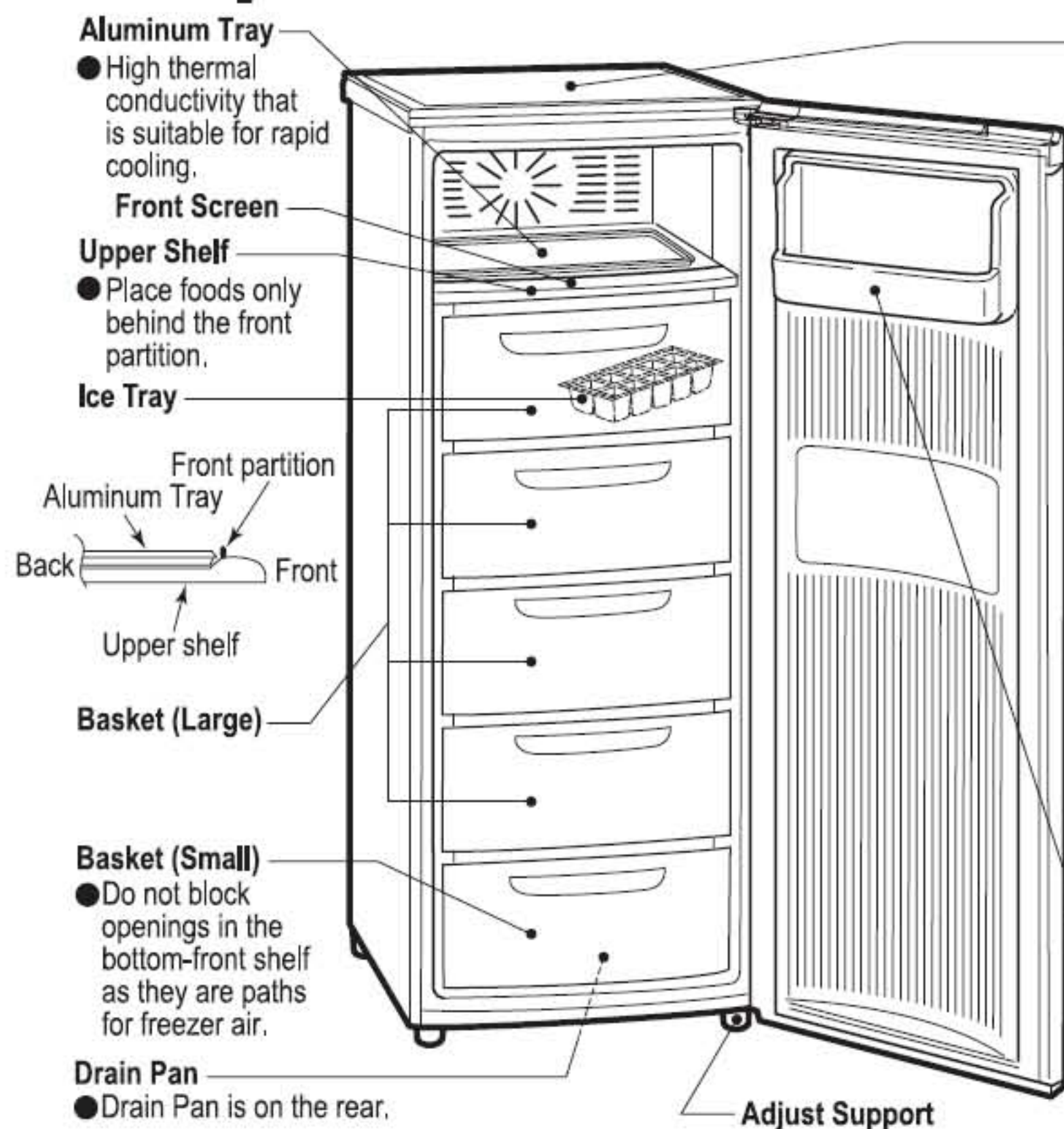

Top Table

- Do not put thermal appliances that can exceed 100 °C such as oven toasters on the top table (allowable temperature limit is 100 °C).
- Allowable loading limit is 30 kg.

⚠ Caution

Do not put fingers near the frame or hinges of the door when closing the door as you may hurt your fingers or hands.



Freezer Pocket

- Not suitable for items that melt easily such as ice cream.

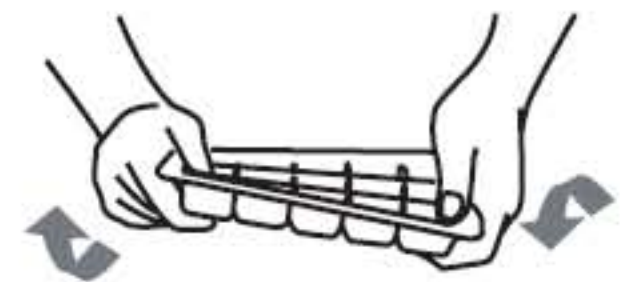
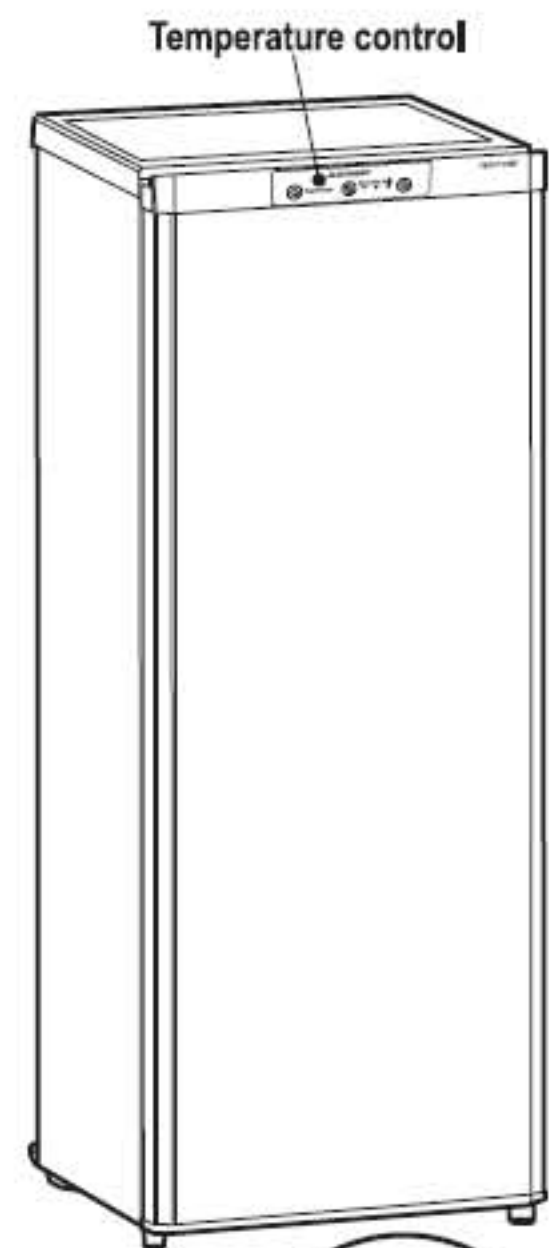

Ice Making Method

- Pour water into the ice tray, to about 80% of its capacity.
- Put the filled ice tray with water filled in the freezing compartment and be careful not to spill any water.
- To take ice out from the ice tray, gently twist the tray with your hands (as shown in the picture) Do not try to bend or break the ice tray.
- Do not put drinking water bottles in this compartment, as the container might break in freezing temperatures.

Attention:

- Placing heavy items, 9 kg or more, in the freezer drawer could result in the freezer drawer being cracked or deformed.
- Immediately after closing the door the freezer air gets rapidly chilled and contracts which may make the door difficult to open. Please wait one or two minutes before attempting to open the door again.
- When the freezer is well chilled and stable, there is a pressure difference between the inside and outside of the freezer so the door may require more effort to open. Open it slowly and firmly by placing your other hand on the unit itself.

Smart tips for using your freezer

Do not overfill with food

Cooling efficiency will be lowered if overfilled.

- Place the foods only behind the front partition. Make sure that all baskets are fully closed so that the door can be completely shut.

Home freezing is recommended while ingredients are fresh

- Foods will deteriorate gradually even after home freezing. Please try to eat foods without leaving them too long.

Do not re-freeze any foods once they have thawed.

This freezer is not an ice machine so it is not suitable for making large amount of ice at once.

Do not use

Any bagged chilling agents (containing ammonium nitrate). Leakage may cause rust or failure.

Wrap

Food to avoid drying and also prevent odors from spreading to other foods.

Cool

Warmed foods before you put them in the freezer.

Adjusting the temperature



Freezer control

- Normally set [Mid]

To cool more or when too cold

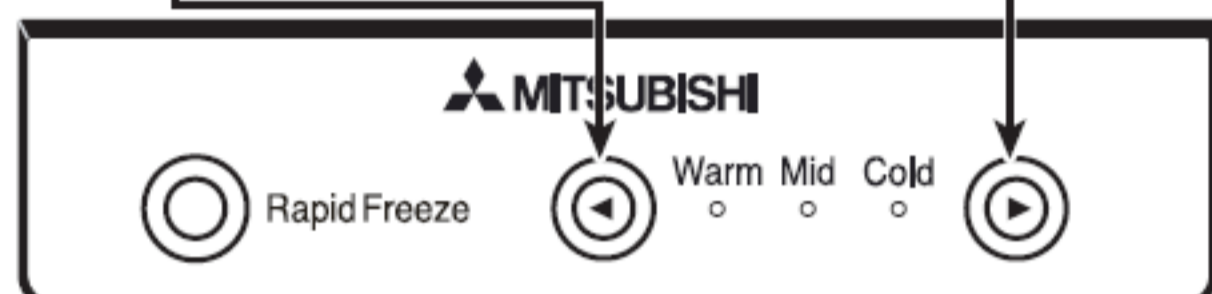
Press  or  to adjust the temperature.



- Green lamp in Temperature Control Display will move as you press  to left and  to right.

– Freezer temperature control position and freezer temperature –

Display lamp	Freezer temperature	Use
Warm (Economy)	2–3 °C higher than medium	<ul style="list-style-type: none"> ● Little frozen food ● When the door usually stays shut
Mid (Medium)	About –18 °C	<ul style="list-style-type: none"> ● For a normal use
Cold	2–3 °C colder than medium	<ul style="list-style-type: none"> ● A lot of frozen food ● When the door is opened frequently

Rapid Freeze

To chill the freezer rapidly and maximum freezing

By Pressing  then rapid freezing will run for about three hours.



- When you wish to stop Rapid Freeze, press the same button once again. Rapid Freeze is turned off and operation returns to normal.
- When Rapid Freeze is stopped, operation returns to normal.
- When the power plug is pulled out or a power cut occurs, press the button again to start the operation once power is restored.
- If you press Rapid Freeze button while defrosting or soon after the compressor has stopped, it will take a little while to get started even though the lamp turns on immediately.

Defrost

It is not necessary to defrost or drain water in drain pan.

CAUTION

1. This appliance is designed for use in ambient temperature listed below.

MODEL NAME	AMBIENT TEMPERATURE RANGE	CLIMATIC CLASS
MF-U160B-A	16 °C ~ 43 °C	T
MF-U160B-NZ	16 °C ~ 43 °C	T

The internal temperatures could be affected by such factors as the location of the refrigerating appliance, ambient temperature and the frequency of door opening, and, if appropriate, a warning that the setting of any temperature control device might have to be varied to allow for these factors.

2. A rise in temperature of the frozen food during manual defrosting, maintenance or cleaning could shorten the storage life.
3. Food to be frozen is not to be placed in direct contact with food in storage and, if appropriate, that it could be necessary to reduce the quantity to be frozen if freezing every day is anticipated.
4. The electrical power failure for 1-2 hour will only slightly effect the inside temperature. However, open & close of the door results in the temperature loss. In case there is more than 24 hours electrical power failure, the food should be taken out from the fridge.
5. In case you are leaving or there is no food in the fridge for more than 3 weeks, The fridge should be unplugged and cleaned.

Maintenance and Troubleshooting

Before you start

Remove the power plug from the outlet

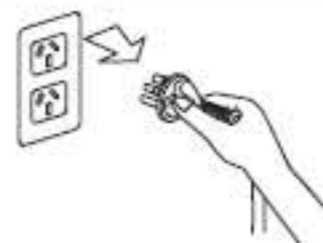

Wait at least 5 minutes before you plug the power plug back into the outlet.

Warning

Failure to remove the power plug can cause electric shock.

Maintenance and cleaning

To get rid of grease and dirt

- Wipe or remove and wash parts with water.
- To remove oily deposits, wet a cloth with lukewarm water and dishwashing detergent and wipe clean. (Oily deposits left on plastic parts can cause them to break.)
- Be sure to completely wipe off any detergent you use.
- For chemically-treated disposable cloths, be sure to read all of the instructions and observe the precautions.
- Do not use alcohol, benzene, scouring brushes, or alkaline detergent. They can damage the surface of plastic parts (door handles, caps, cases, etc.) and cause them to break.



Warning

Do not put water directly inside and outside of the unit. (It may cause failure or electrical leakage.)

Drain pan

- ① The freezer is pulled out forward.
 - ② Remove the drain pan as shown.
 - ③ To install, insert the drain pan completely so the drain pipe is located above the drain pan. (Failure to insert the drain pan completely can lead to water leaks, noise, and vibration.)
- If the drain pan becomes dirty, evaporation becomes difficult and may result in an over flow or bad odor.

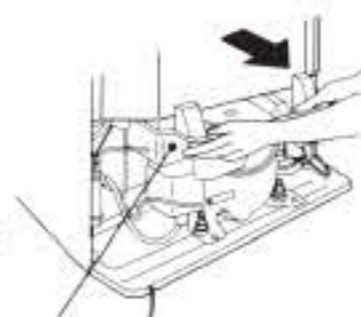

Drain Pan is on the rear.

Rear of the freezer and floor

- ① The freezer is pulled out forward.
- ② Wipe away any dirt from the wall, floor, or rear of the freezer. Air circulation can cause dust to collect in the area behind and under the freezer. These areas also easily blacken.



Caution

The compressor becomes very hot. Do not touch. Because of other possible hazards in the bottom rear of the freezer, keep hands out of this area. (Doing so can cause injury)

How to remove and reinstall the sliding basket

- ① Pull the sliding case towards you.
 - ② Hold the handle, lift the front part and pull it out.
- To reinstall the basket, please do it in the reverse order.

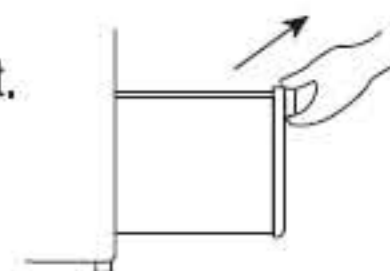

How to remove and reinstall the pocket

- ① Push the inside panel of the freezer out.
 - ② Lift the pocket and pull it forward
- To reinstall the basket, please do it in the reverse order.

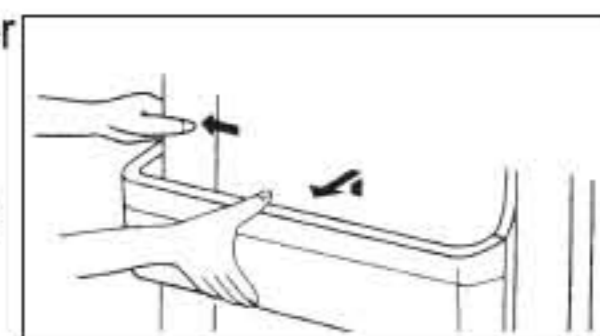

After maintenance

Inspecting the power plug, and outlet

- Is the power plug damaged?
- Is there abnormal heat buildup in the power plug?
- Is the power plug inserted securely into the outlet?
- Has dust collected on the power plug?
- Is the outlet loose?



Warning

Dust build up or damage to the power plug can cause electric shock or fire.

What to do

Blackouts (electric power goes out)

- Refrain from opening and closing the freezer doors and avoid storing additional food items in the freezer.

Long period of non use

- After removing the power plug from the outlet, clean the interior of the freezer and leave the doors open for 2~3 days to let interior dry completely.

* Failure to let the interior of the freezer dry completely can cause molding, odors.

Transporting the freezer

1. Wear protective equipment (thick work gloves).
 2. Discard the water in the drain pan.
 3. Carefully move the freezer with two or more people, holding the lower front interior and the handy-grip recesses on the upper rear of the unit.
- Do not lay the freezer down. (Doing so can cause the compressor to malfunction.)
 - If changing residence, it is not necessary to change the frequency of the power supply. (Both 50 and 60 Hz are compatible.)



Safety Precautions









■ Danger and the degree of danger caused by improper handling are categorized and described using the following symbols.

■ Meaning of symbols.



















■ In the case of a malfunction or defect, immediately turn off the freezer and contact your freezer retailer, the Mitsubishi Electric Maintenance Service, or a customer service representative.

 **Warning** Improper handling can cause death, serious injury, etc.









 **Caution** Improper handling can cause injury or damage to the house, furnishings, etc.

 Do not do	 Do not touch	 Do not attempt to disassemble, repair, or alter	 Do not get wet or dampen with water
 Be sure to follow the instructions as indicated	 Be sure to remove the power plug from the outlet	 Be sure to earth the freezer	 Do not touch with wet hands

Warning

<p>Do not store medicine or scientific specimens in the freezer. Items that require strict management cannot be stored in household freezer.</p> <p> Do not store</p>	<p>Do not pull on the power cord to remove the plug. Doing so can damage the power cord and cause electric shock or a fire.</p> <p> Prohibited</p>	<p>Do not place the freezer outdoors, in a place of high humidity or where it might get wet. Electric insulating damage can cause a shock or fire.</p> <p> Do not get wet</p>
<p>Do not use flammable sprays near the freezer. Sparks from electric contact can cause a fire.</p> <p> Do not use</p>	<p>Do not disassemble, repair, or alter. Doing so can cause injury, electric shock, or a fire.</p> <p> Do not disassemble</p>	<p>Do not wash with water or spill food liquids on the freezer. Water and food liquids can cause electric shock or a fire. Clean up spills immediately.</p> <p> Do not get wet</p>
<p>Do not place objects on top of the freezer. The objects may fall when the doors are opened and closed and cause injury.</p> <p> Prohibited</p>	<p>Remove the power plug from the outlet before maintenance. Failure to do so can cause electric shock or injury.</p> <p> Remove the plug</p>	<p>Do not place volatile flammable items inside the freezer. Benzene, cosmetics, and hair products can combust and explode.</p> <p> Do not store</p>
<p>Do not place containers with water on top of the freezer. Wet electrical parts can cause electric shock or fire.</p> <p> Do not get wet</p>	<p>In case of a malfunction (burning odor is detected, etc.), remove the power plug from the outlet and turn off the freezer. Continued operation of the freezer with a malfunction can cause electric shock or a fire.</p> <p> Remove the plug</p>	<p>Do not hang on the door or try to get in the freezer. The freezer may fall, be damaged and may cause injury. It is also dangerous because if children climb into the freezer they can become trapped.</p> <p> Prohibited</p>
<p>Do not remove or insert the power plug with wet hands. Doing so can cause electric shock.</p> <p> No wet hands</p>	<p>Use a dedicated outlet for the power supply that meets the rating specified on the rating label. (The rating label is located on the door-liner of the freezer compartment.) Using an extension cord or plugging in too many power cords into the outlet can cause heat buildup or a fire. Page 2</p> <p> Only use an outlet that meets the specified rating</p>	<p>Do not press the back of the freezer against the power plug. Do not damage the power plug. Pressing against, placing weight on, folding, or bundling the power plug can cause electric shock or a fire.</p> <p> Prohibited</p>
<p>Remove any dust from the power plug. Insulation failure can cause a fire.</p> <p> Remove dust</p>	<p>Do not use damaged power plugs, or loose outlets. Doing so can cause electric shock or a fire.</p> <p> Do not use</p>	<p>To prevent children from becoming trapped inside, remove the door when placing the freezer in storage. It is dangerous if anyone gets trapped inside.</p> <p> Remove the door</p>

Caution

<ul style="list-style-type: none"> If your power cord has a 3-pin power plug and the electrical outlet is not equipped with such a plug, change the electrical outlet, not the power plug. Do not cut or remove the 3-pin power plug. If the power cord is damaged, call our MITSUBISHI SERVICE CENTER for the replacement, in order to avoid a hazard. An electrician or technician is required to replace the power plug. 	<p>Use the adjustable supports so the freezer is securely installed on a strong level surface. If the freezer is not installed properly, it could move and cause injury. Page 2</p> <p> Install level</p>	<p>Do not eat food that has a strange odor or is discolored. Doing so can cause food poisoning or illness.</p> <p> Prohibited</p>
<ul style="list-style-type: none"> This freezer uses flammable foaming gas for insulation. 	<p>Use the transportation handholds when transporting the freezer. Holding other parts can cause injury. Page 5</p> <p> Hold the handholds</p>	<p>Do not touch food items or containers in the freezer compartment with wet hands. Doing so can cause frostbite.</p> <p> No wet hands</p>
<ul style="list-style-type: none"> Please deliver the unit to specialized industrial waste dealer when you dispose of it. Please follow the rules in your country. If not properly disposed of and a refrigerant leak happens, it may cause ignition or explosion. <p> Dispose of properly</p>	<p>Do not excessively pack the freezer with food or remove the shelves with excessive force. Doing so can cause food items to fall and cause injury.</p> <p> Prohibited</p>	<p>Do not put your hands or feet underneath the freezer. The metal plates, etc., on the bottom of the freezer can cause injury.</p> <p> Do not touch</p>
	<p>Do not place glass bottles in the freezer compartment. The contents of the bottle can freeze and cause the bottle to break and cause injury.</p> <p> Do not store</p>	<p>Do not put your hands in the machine area in the rear of the unit. It can cause a burn or injury.</p> <p> Do not touch</p>
		<p>Do not put fingers near the frame or hinges of the door when closing the door. You may hurt your fingers or hands.</p> <p> Hold the handle</p>

Troubleshooting

If the problem is not resolved after troubleshooting, immediately contact your freezer retailer.

Problem	Check the following	Solution and reasons
Freezer does not cool.	① Is the freezer receiving power?	① Check the power cord, plug, power point and the circuit breaker or fuse on house power board.
Freezer does not cool sufficiently.	① Is the temperature control set to [Warm]? ② Has the freezer just been installed? ③ Is there sufficient space around the freezer? Is the freezer in direct sunlight or is heat ventilation hampered? ④ Have you blocked the flow of refrigerated air? Is the door opened frequently or left ajar?	① Press button on the temperature control to select the [Mid] position. Page 4 ② It sometimes takes 24 hours for the freezer to cool in the summer. ③ Check that the freezer is installed and set up correctly. Page 2 ④ Check that the freezer is not excessively packed with food items and that the doors are not ajar. Page 3
Condensation collects on the exterior of the freezer and frost collects in the freezer compartment.	① Is the door opened frequently or left ajar? ② Is it a rainy or highly humid time of the year?	① When moisture in the air is chilled, it will become frost and prevent the door from properly closing. ② Condensation may temporarily collect on the freezer. Wipe the freezer with a dry cloth. In addition, frost may form easily in the freezer compartment. Open and close the freezer compartment door only as much as necessary.
Door is easy to open or difficult to close	① Are any food items in contact with the door? Is the freezer excessively packed with food items? ② Is the power cord pinched between the door and the freezer?	① Do not store food items so that they stick out from the shelves or cases. ② Remove pinched power cord. Be careful not to pinch items such as food items, the power cord, or plastic bags between the door and the freezer.
Door is difficult to open	The door may require more effort to open as differences in temperature between the inside and outside of the freezer will cause a pressure difference. Please wait one or two minutes before attempting to open the door again immediately after closing the door. When the freezer is well chilled and stable, open it slowly and firmly by placing your other hand on the unit itself. Page 3	
Loud or disturbing noises. The noises listed to the right are normal.	① The noise gets loud suddenly or the tone changes. ② Sometimes hissing or bubbling sounds are heard. ③ Sometimes after opening the door, a cracking sound or the sound of dripping water is heard from within the freezer.	① After defrosting, the sound may increase occasionally. ② These are the sounds of the flowing refrigerant (gas). ③ A creaking or cracking sound is made when warm air has entered the freezer, causing the plastic parts to expand.
Exterior gets hot.		The freezer is equipped with piping to prevent condensation and for heat ventilation from the sides and above the unit. When the freezer is first used and during the summer, warm air can flow from under the freezer, especially when the exterior temperature is 50~60°C. This is necessary for cooling and is not a malfunction.

Fine adjustments of the freezer temperature is possible.



1. Set Fine Temperature Control Mode

Press both and at the same time for five seconds.

3. Cancel Fine Temperature Control Mode

To cancel the mode, please do it in the reverse order.
If two lamps are still turned on, its cancellation may not have been completed because only one lamp should be on after canceling the mode.
Please check the temperature setting once again in this case.

2. Operate Fine Temperature Mode

Operating method is the same as adjusting the temperature. [Page 4](#)

- Adjust the temperature by 0.3 – 0.5 °C.
- When making fine temperature adjustments, two lamps light or flash instead of one lamp for a normal temperature control (lamps flash in two-second increments).

Example

When it is a little warm than "Mid"



When it is a little cold than "Mid"



Specifications

Model name	MF-U160B	
Type	Freezer	
Volume	160 L	
Outside dimension	Width	480 mm
	Depth	586 mm
	Height	1291 mm
Weight	37 kg	
Voltage	230-240 V~	
Frequency	50 Hz	

Accessories	Quantity
Freezer Pocket	1
Basket (Large)	4
Basket (Small)	1
Drain Pan	1
Aluminum Tray	1
Ice Tray	1

This appliance is designed for use in Australia and New Zealand only and cannot be used in any other country. No service is available outside of Australia and New Zealand.

MITSUBISHI ELECTRIC CORPORATION

HEAD OFFICE : TOKYO BUILDING 2-7-3, MARUNOUCHI, CHIYODA-KU, TOKYO 100-8310, JAPAN

PHONE: +81 (3) 3218-2111

<http://Global.MitsubishiElectric.com>

Distributed by:

MITSUBISHI ELECTRIC AUSTRALIA PTY LTD.

(Incorporated in New South Wales) ABN 58 001 215 792

New South Wales:

348 Victoria Road, Rydalmere NSW 2116 Ph: (02) 9684 7777, Fax: (02) 9898 0484

Queensland:

Unit 12, 469 Nudgee Road, Hendra, QLD 4011 Ph: (07) 3623 2000, Fax: (07) 3630 1888

South Australia / Northern Territory:

77 Port Road, Hindmarsh SA 5007 Ph: (08) 8340 2000, Fax: (08) 8340 0555

Western Australia:

Unit 5, 329 Collier Road, Bassendean WA 6054 Ph: (08) 9377 3400, Fax: (08) 9377 3499

Victoria / Tasmania:

Suite 28, 270 Ferntree Gully Road, Notting Hill VIC 3168 Ph: (03) 9535 7800, Fax: (03) 9535 7801

Distributed by:

BLACK DIAMOND TECHNOLOGIES LIMITED (BDT)

Wellington Office (Head Office)

1 Parliament Street PO Box 30-772 Lower Hutt Ph: (04) 560 9100, Fax: (04) 560 9133

Auckland Office

Unit 1, 4 Walls Road Penrose Auckland PO Box 12-726 Ph: (09) 526 9340, Fax: (09) 526 9369

Christchurch Office

Suite 2, Level 1, 37 Manderville Street Christchurch PO Box 1604 Ph: (03) 341 7052,
Fax: (03) 341 7054