



Refrigerator-Freezer
MODEL

MR-WX743Y

OPERATING INSTRUCTIONS



R600a

Store food in the best way for consumption!

Place food and drinks in the compartments suitable for preserving them.
Convenient functions can be easily set by simply touching icons.

Refrigerator Compartment

About 0°C to 6°C

- Foods that are used daily
- Foods you do not want to freeze



→ Pages 10 - 11

Slide Cases

About -3°C to 3°C

Upper Case
Lower Case

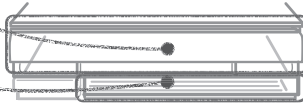

- Dairy products: Yogurt, cheese, etc.
- Fish paste products: Steamed fish paste, fish cake, etc.
- Processed food: Ham, sausages, etc.



Recommended!

The lower case can be set with .



Supercool chilling To preserve meat or fish below freezing

Preserves flavor below 0°C for a long time without freezing!

- Meat
- Fish



Ice Making Compartment

→ Pages 12 - 13

Ice is made automatically.

Freezer Compartment

About -22°C to -16°C

- Frozen food
- Ice cream
- Food frozen at home
- Bread

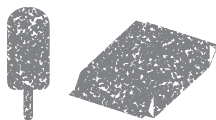

If you store food that is Supercool Frozen in the freezer compartment, it can be stored for a long time without losing its taste and texture.

Operation Panel

→ Pages 8 - 9



If you touch the left button, icons will be displayed. You can select the setting that you prefer.

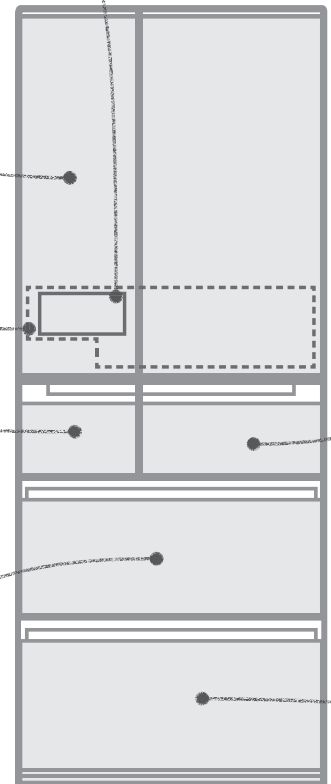

- The temperatures described here are measured in the lower centre of the refrigerator after the temperature has stabilized when the surrounding temperature is 30°C and the doors are closed without any food inside. The temperature fluctuates with factors such as food storage conditions and how often the doors are opened and closed.

Contents

(Pages)

Safety Precautions..... 4-5

From Installation to Operation 6-7

How to Use the Operation Panel ... 8-9

Refrigerator Compartment / Slide Cases ... 10-11

Ice Making Compartment ... 12-13

Versa Compartment ... 14-15

Soft-Freezing / Supercool Freezing ... 16-18

Freezer Compartment 19

Vegetable Compartment ... 19

Energy Saving Mode 20

Performing Temperature Adjustment ... 21-22

RAPID COOL..... 23

Power Save Mode 24-25

Cleaning 26-30

Other Issues 31-34

Power Outages 31

To Prevent Accidental Button Operation
(Child Safety Lock) 31

To Reset Settings 31

Alarm Sounds 32

When Not Using the Refrigerator for a
Long Time 32

To Move or Transport the Refrigerator 33

To Control the Temperature More Precisely ... 34
etc.

Troubleshooting 35-38

Specifications 39

● This refrigerator is manufactured for refrigerating and freezing foods in general households. For industrial use, please use a commercial refrigerator.

● The material names are indicated on the main plastic parts to facilitate recycling.

● This refrigerator uses non-freon refrigerant (isobutane) and non-freon foam insulation material (cyclopentane).

Energy Saving Mode → Page 20



★ ★ ★ ECO

With the ECO guide, you can check your refrigerator's ECO level.

Versa Compartment

→ Pages 14 - 15

Soft-Freezing: About **-9°C to -5°C**

(Can also switch to freezer)

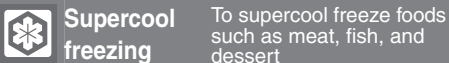

- Blocks of meat
- Ground meat
- Fillets, cod roe

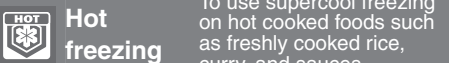

- Freshly cooked rice
- Curry
- Sauces

Soft-Freezing / Supercool Freezing
→ Pages 16 - 18

Vegetable Compartment

→ Page 19

About **3°C to 9°C**

- Vegetables
- Fruits
- Drinks



The water that evaporates from the food is kept inside the compartment to maintain the moisture. Storing fruits and vegetables in plastic wrap keeps them even fresher.

Compartment Introduction

Detail setting

Safety

Installation

Operation Panel

REF Slide Cases

ICE

S-COOL

FRZ VEG

ENERGY SAVING

Temperature Adjustment

RAPID COOL



PWR SAVE

Cleaning





Trouble-shooting

Safety Precautions

The following describes the safety precautions to follow in order to prevent injury to the user and others, as well as to prevent damage to property.

	Warning	Improper handling that can result in grave consequences such as death or serious injury.
	Caution	Improper handling that can result in personal injury or damage to your house, household furnishings, etc.

■ Meaning of symbols.

	Prohibited		Follow the instructions
	Water prohibited		Remove the power plug.
	Caution		



Warning

When Installing the Refrigerator



Water prohibited

Do not install the refrigerator outdoors or in places exposed to water or excessive humidity.

Water may cause insulation failure, resulting in an electric shock or fire.

➔ Page 6



Follow the instructions

Leave space around the refrigerator.

If refrigerant leaks, it may accumulate and catch fire or explode. ➔ Page 6

Anchor the refrigerator to a strong wall or post to protect against damage during earthquakes.

The refrigerator may tip over and cause injury. ➔ Page 7

Power and Power Plug



Prohibited

Do not crush the power plug with the rear of the refrigerator.

Do not damage the power cord.

Pressing, folding, bundling, or placing heavy objects on the power cord may cause an electric shock or fire.

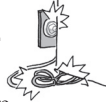

Do not use damaged cords or plugs, or loose sockets.

Doing so may cause an electric shock or fire.

Do not pull the cord when unplugging the power plug.

The cord may be damaged, resulting in an electric shock or fire.

Do not plug in or out the power plug with wet hands.

Doing so may cause an electric shock.



Follow the instructions

Use a dedicated outlet for the power supply that meets the rating specified on the rating label. (The rating label is located on the refrigerator compartment.)

Using extension cords and plugging too many leads into a single socket can cause heat build-up or fire. ➔ Page 6

Insert the power plug with the cord facing down, and fully insert the prongs.

Inserting the plug upside-down places stress on the cord and may cause heat generation or fire.



If the power cord is damaged, call our MITSUBISHI ELECTRIC SERVICE CENTRE or its service agent for the replacement.

If the power cord is damaged, purchase a new cord from MITSUBISHI ELECTRIC SERVICE CENTRE. Make sure that the power cord is designed for this model.

Power and Power Plug



Follow the instructions

Remove dust periodically from the power plug.

Dust may cause insulation failure, resulting in fire.



Remove plug

Remove the power plug before cleaning.

Otherwise an electric shock or injury may result.

When Using



Prohibited

Do not damage or drive screws into the refrigerator's refrigerant circuit (pipes).

Because combustible refrigerant is used, this may result in fire or an explosion.

Do not use electrical appliances inside the refrigerator.

The refrigerant gas leaking into the compartment with sparks from an electrical contact may cause fire and explosion.

Do not place volatile, inflammable objects inside the refrigerator.

Benzene, cosmetics and hair dressing products may catch fire or explode.

Do not store chemicals or scientific specimens in the refrigerator.

Substances that require strict control must not be stored in household refrigerators.

Do not place objects on top of refrigerator.

Objects may fall when the doors are opened or closed and cause injury.



Do not hang from the door or handle.

Do not climb on an open door.

Do not apply a heavy load.

The refrigerator may tip over and cause injury.



Do not apply excessive force to glass doors or shelves.

An impact can cause the glass to crack and may result in injury.

Do not touch the mechanical area of the automatic ice maker (area above the ice storage box).

Doing so may result in injury.

Do not use combustible sprays near the refrigerator.

Sparks from an electrical contact may cause an ignition and fire.



If an abnormality or malfunction occurs, stop operation immediately and contact the retail store where you purchased the refrigerator or a MITSUBISHI ELECTRIC SERVICE CENTRE or its service agent.



Warning

When Using



Prohibited

Do not use in a shed or garage.

Small animals may damage the electrical wiring and cause an electric shock or fire.



Water prohibited

Do not place water containers on top of the refrigerator.

Exposing electrical parts to water may cause an electric shock or fire.

Do not wash with water or spill soup or juice onto the refrigerator.

Water or other liquid may cause an electric shock or fire. Wipe off any liquid immediately.



Follow the instructions

If you notice a gas leak, do not touch the refrigerator. Open windows to ventilate.

Sparks from an electrical contact may cause an explosion or fire.

When the doors are opened or closed, beware not to hit any furniture.

The door or furniture may be damaged and cause injury.

Malfunctions and Long-Term Storage



Prohibited

Do not disassemble, repair, or alter. Do not use while parts are damaged.

Doing so may cause injury, electric shock or fire.



Follow the instructions

If the refrigerant circuit (pipe) is damaged, do not touch the refrigerator and avoid using flames. Open windows to ventilate.

If the refrigerant circuit is damaged, contact the retail store.

Failing to do so may cause a fire.



When not using the refrigerator for a long time, unplug the power plug and open the doors to dry the refrigerator.

If the refrigerator is not dried sufficiently, refrigerant may leak due to condenser corrosion and cause a fire or explosion.



Remove plug

If an abnormality occurs (such as a burning odor), unplug the power plug and stop refrigerator operation.

Continuing to operate with an abnormality may cause an electric shock or fire.

When Recycling



Follow the instructions

For storage, make sure to pull out and remove the door seal.

There is a possibility of a child getting trapped in the refrigerator during storage.



Contact the retail store or municipal government for details about correct refrigerator disposal.

Improper disposal may cause refrigerant leaks, resulting in a fire or explosion if exposed to a flame.



Caution

When Installing/Transporting the Refrigerator



Follow the instructions

Anchor the refrigerator to a strong and level floor by adjusting the adjustable supports.

Otherwise, the refrigerator may move and cause injury.

➔ Pages 6 - 7

Use the transportation hand-holds or the parts instructed when transporting the refrigerator.

Holding other parts may result in injury.

➔ Page 33

When moving the refrigerator, lay a protective sheet on the floor and move the refrigerator slowly.

Failing to do so may result in floor damage or injury.



When Using



Prohibited

Do not pack in excessive amounts of food. Do not pull the shelves with excessive force.

Food may fall and cause an injury.

Do not place glass bottles in the freezer, ice making, and versa compartments.

The bottle may break if the liquid inside freezes, causing an injury.

Do not put your hands or feet under the refrigerator.

The steel plates or other parts may cause injury.



Do not eat food that is discolored or has a bad odor.

It may result in food poisoning or illness.

Observe the following when opening and closing the doors.

- Do not open or close the doors when another person is touching the refrigerator.
- Do not put your fingers on the top edge of a drawer-type door while closing it.
- Do not open or close the doors with excessive force. (Food may fall out.)
- Be careful not to trap your fingers or any other part of your body.
- Be careful not hit a part of your body.
- Do not trap your feet with the bottom drawer. (Danger of your toes caught by the drawer.)

Failing to follow the precautions above may result in injury.



Do not touch food or containers in the freezer compartment with wet hands.

It may cause a cold injury.



Follow the instructions

Be careful when attaching and removing the glass shelf and pocket.

If it is attached improperly, it could come loose and fall, causing injury.



Caution

Be careful when breaking apart ice stuck in the ice storage box.

There is a risk of injury.

From Installation to Operation

1 Installation

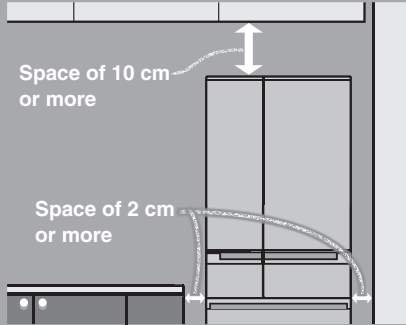

Install the refrigerator in the following kind of location.

- **A place with good ventilation and not exposed to direct sunlight or hot air**
To keep good cooling performance and reduce power costs.
- **A place with low humidity**
To prevent it from rusting.
- **A strong and level place**
To prevent vibration, noise, and ajar or tilting doors.
To prevent deformation or discoloration of the floor materials due to the weight or heat.
(If the refrigerator supports may sink into the floor, lay a strong plate or board underneath)
- **A place away from other devices**
To prevent noise or video interference with devices such as televisions.
- **There should be space of 2 cm or more on the left and right of the refrigerator, and 10 cm or more from the ceiling.**
To allow heat to dissipate from the top and the sides of the refrigerator.

Use in hot spring and geothermal areas

Corrosion control treatment may be required for the refrigerant circuit (pipe) due to generation of corrosive gases. Contact the retail store where you purchased the refrigerator.



Water prohibited

Do not install the refrigerator outdoors or in places exposed to water or excessive humidity.
Water may cause insulation failure, resulting in an electric shock or fire.



Follow the instructions

Leave space around the refrigerator.

If refrigerant leaks, it may accumulate and catch fire or explode.

2 Connect the Power Supply

*Connect power supply soon after installing the refrigerator

Dedicated outlet that meets the specified rating.



Turn on the power of the refrigerator as soon as possible.

● Use a dedicated outlet

Use a dedicated outlet for the power supply that meets the rating specified on the rating label. (The rating label is located on the refrigerator compartment.)

⚠ Warning

Using outlets that do not meet the specified rating or plugging in too many leads into a single socket can cause heat buildup or fire.

- **The refrigerator will not be damaged even if the power is supplied soon after installation. It takes a while for the refrigerator to cool, therefore supply power as soon as possible.**

● Electrical Connections

Make sure this unit is properly grounded.

- The refrigerator should always be plugged into its dedicated electrical outlet.
This will provide the best performance and prevent electrical circuits from being overloaded and causing a fire.
Make sure that the electrical outlet provides the proper voltage.
Extension cords are not recommended.
- If your refrigerator is installed in the high humidity location, not only ground connection but also installation of the earth leakage breaker is recommended.
- If the power cord is damaged, purchase a new cord from MITSUBISHI ELECTRIC SERVICE CENTRE. Make sure that the power cord is designed for this model, in order to avoid a hazard.
- If the power cord is damaged, call our MITSUBISHI ELECTRIC SERVICE CENTRE or its service agent for the replacement, in order to avoid a hazard.

3 Adjustment and Anchoring (To prevent vibration, noise, movement, and doors left ajar)

Turn the adjustable supports so that they touch the floor and anchor them so that the refrigerator will not move.

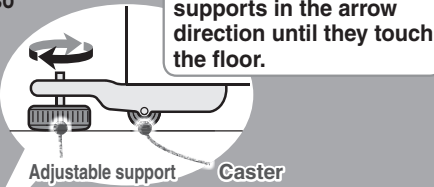
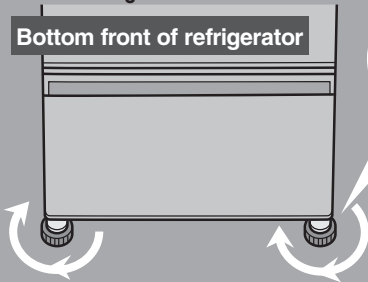

Follow the instructions

Anchor the refrigerator to a strong and level floor by adjusting the adjustable supports. Otherwise, the refrigerator may move and cause injury.

● Adjust the tilt with the adjustable supports.

Adjust the adjustable supports as shown in the figures below to make the refrigerator level.

The right door tilts down

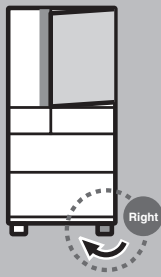

Rotate and lower the right side.

The left door tilts down

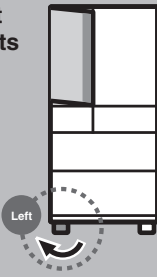

Rotate and lower the left side.

If the refrigerator tilts forward, the doors will easily become ajar.

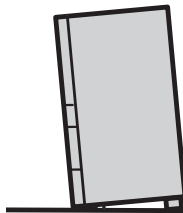

*A few days after installation, the floor may sink due to the refrigerator's weight. Readjust the tilt with the adjustable supports.

If the door is still tilted after adjustment of the supports

When installing the refrigerator in the corner of a room, one of the rear supports may sink, causing the refrigerator to tilt. If this happens, use a strong board for adjustment. (Normally, use a board with a thickness of 2 to 3 mm.)

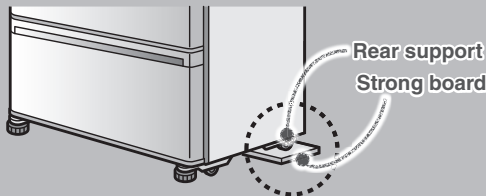

● After adjustment, attach the adjustable support cover.

(The adjustable support cover is stored inside the refrigerator compartment at shipment)

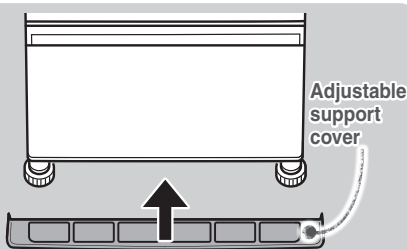

Fully insert the adjustable support cover horizontally until it touches the rear side.

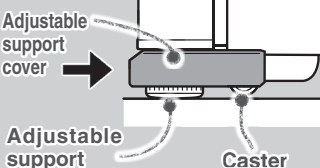

Beginning Use

- **The refrigerator takes time to cool completely.**
 - Wait until the refrigerator has sufficiently cooled before storing ice cream and foods cooler than room temperature.
 - Do not open the doors more than necessary, and close them as soon as possible.
 - In summertime, it may take more than 24 hours to make ice immediately after installation.
- **There may be a plastic odor.**

This odor will gradually disappear.

Ventilate the room to prevent any odors from being trapped.
- **The refrigerator will be powerfully cooled (this is the same for summertime).**
 - Because heat will radiate out of the refrigerator in order to cool its contents, the sides will become hot.
 - Because the compressor will enter high-speed operation, the operation sound will grow loud.

Installation

Prepare for Earthquakes

- **It is recommended to pass 2 strong belts through the hand-holds on the top rear of the refrigerator and anchor them to a strong location, such as a wall or post.**

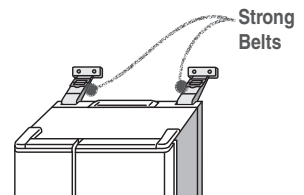

Do not damage the refrigerant circuit (pipes) or drive screws into it.

Because combustible refrigerant is used, this may result in fire or an explosion.

Prohibited

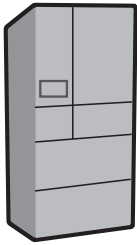

How to Use the Operation Panel

Touching  will cause the operable icons to light up.

To save power, all displays other than  are usually turned off (it turns off if there is no operation for about 30 seconds).



When operating, be sure to touch the buttons with your fingers.

ECO GUIDE

The refrigerator's ECO level is indicated with the number of ★ marks. → Page 20

Child Safety Lock → Page 31

Detail Setting

Touch  to go to compartment selection;

Touch  to go to various settings. → Pages 21 - 25

Example: When setting the refrigerator compartment to "M"

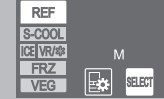

Touch an icon to display its setting details.

When setting or cancelling settings (or cancelling in the middle), touch one of these.



If you touch the operation panel, icons will be displayed. You can select the setting that you prefer.



Energy Saving Mode
To successfully save power



Supercool chilling
To preserve meat or fish below freezing



Supercool freezing
To supercool freeze foods such as meat, fish, and dessert



Hot freezing
To use supercool freezing on hot cooked foods such as freshly cooked rice, curry, and sauces

Operation Example (When Setting Supercool chilling)

1 Touch

When you keep the door of the refrigerator open, touch  for about 1 second. (until the buzzer sounds once)



2 Touch the icon to set

Here touch .

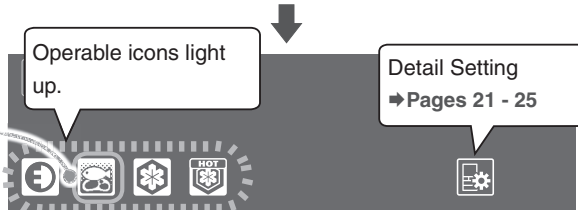

3 Confirm the setting details and compartment, then touch .

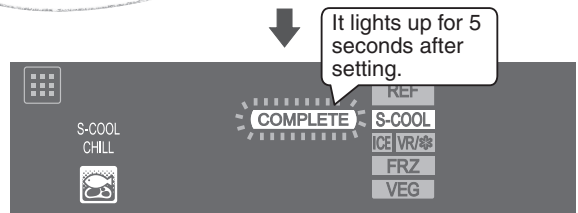
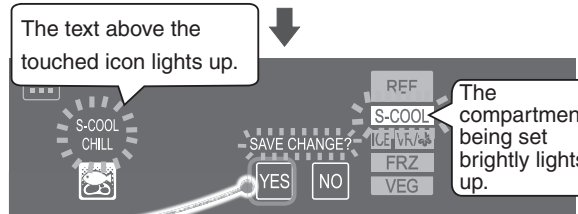

Operation Panel

In ② and ③, touching  returns the display to the previous state.

To Cancel the Setting/Cancel in the Middle

1 Touch

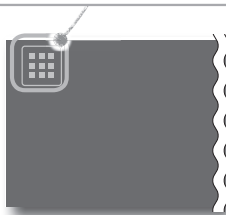

2 Touch the icon to cancel

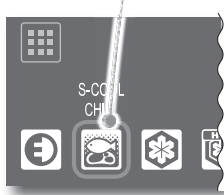

3 Touch

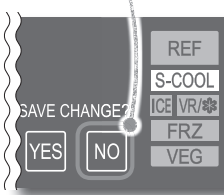

The text above the icon will disappear.



In the following cases, the display may not change even when you touch it.

The operation panel or your fingers are wet or dirty.



You are wearing gloves or have sticking plaster on your finger.



The interval between touches is too short. (Pressing repeatedly may cause a misdetection)

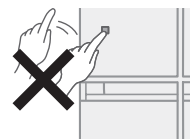

- Wipe the moisture and dirt off your fingers. Perform operations with your hands. After you have touched an icon, confirm that the display has changed before touching again.
- The response may vary, depending on the surrounding temperature, humidity, the health condition of the person who operates it, and the operating condition of neighboring electric appliances.

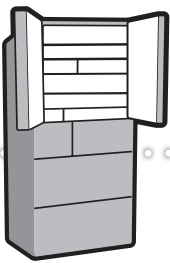

Compartment Introduction

Refrigerator Compartment / Slide Cases

Use the refrigerator compartment when storing foods that will be consumed soon. Foods such as meat, fish, dairy products, and processed food can be kept fresh longer in the slide cases at a temperature lower than the refrigerator compartment.

Refrigerator Compartment About 0°C to 6°C

Separate Glass Shelf

The height of the wide shelf can be changed on the left and right sides.

Left: Glass Shelf (Middle)

The height can be changed upward and downward. Lowering it places it at a storage location suitable for the egg tray.



Right: Slide Glass Shelf (Front) (Back)

The height can be changed upward and downward. If you slide the shelf to the back, you can store high objects.

Interior Light

Uses 10 LEDs.

Glass Shelf (Upper)

The height can be changed upward and downward.

Glass Shelf (Lower)

Adjustable Pocket (Large)

Adjustable Pocket (Large) (Small)

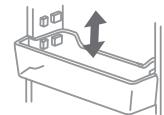

The height of the adjustable pockets can be changed.

Adjustable Pocket (Small)

Partition

Egg Tray with Egg Shelf

Bottle Pocket (Small)

Rotating Partition

Open and close the doors slowly. If you open or close the doors with force, the rotating partition may open to the front. Return the partition to its regular position before closing the door. (Otherwise it may be damaged.)

Upper Case Cover

Upper Case

Lower Case

Bottle Pocket (Large)

Store plastic or glass bottles.

Air Outlet

If food with a high water content is placed near the air outlets, it may freeze.

➔ Page 35

Preventing the Transfer of Odors



It is recommended that foods that have strong odors or easily absorb odor are either wrapped thoroughly or stored in an airtight container.

Kimchi, pot stickers, sardines (seafood), beef, etc.
Food that transfers odors easily



Rice, potato salad, etc.
Food that may easily absorb odors



The door will automatically close from halfway with the Auto closer

With the door of the refrigerator compartment open at an angle of about 20 degrees or less, the door will close automatically.

The door may stop before closing completely if you swing the door too softly.

If the door stops (ajar), it will not close automatically.

The speed of the closing door may change according to the amount of food stored.

When a door is open, you will be informed with the door alarm.

➔ Page 32

Slide Cases About -3°C to 3°C

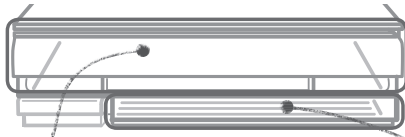

Upper Case
(About 0°C to 3°C)

- Processed food such as sausage, ham and dairy products can be preserved.
- Do not store food that is easily frozen.
- The temperature cannot be adjusted.

At the time of purchase, the lower case is not set to Supercool chilling.
When setting Supercool chilling, use the following settings.

Lower Case

Supercool chilling can be set with .

- Food will not freeze, even below the freezing point (about -3°C to 0°C)
- The freshness of meat and fish can be prolonged without freezing.

Preserving Meat or Fish Below Freezing



Supercool chilling

Supercool chilling stores and preserves meat or fish for a long time at a temperature lower than the refrigerator compartment or upper case without freezing them. Once it has been set, Supercool chilling will be the default setting until it is disabled.

To Set

1 Touch  on the operation panel

2 Touch 

3 Touch 

The settings are finished.

It doesn't matter whether you put food in before or after the settings.

To cancel the setting → Page 9

*If you disable the setting, the lower case can be used in the same way as the upper case.

REF
Slide Cases

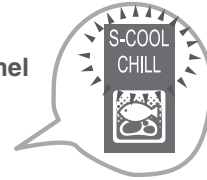
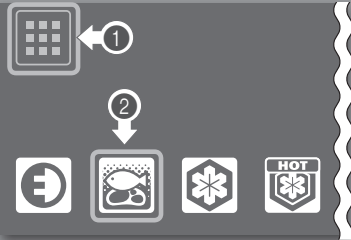

Supercool chilling Is Very Useful



Tastes good

Because the food doesn't freeze, the fresh flavor lasts longer!

Kept fresh

Meat and fish last longer and are fresher than in the refrigerator compartment or upper case!

Estimated Preservation Period

Meat..... Up to about 7 days

Fish..... Up to about 5 days

Sashimi (Block)..... Up to about 3 days



*The preservation period will differ according to the freshness of food before storing it and the use condition of the refrigerator.

Tips

- Do not leave food hanging over shelves or pockets.
- Do not place bottles that cannot fit all the way to the bottom of the bottle pocket.
- Do not attach a case that you purchased separately onto the outside of a pocket.
- Do not heat the glass surfaces of the glass shelves or place hot objects on them.
- Do not close the door while food is in front of the upper case or the lower case.
- Fully stow away the cases. Otherwise they may keep a door ajar and reduce the cooling performance, or food may fall and cause damage to a case.
- Do not pile food to the top. Leave a gap so that cold air can flow to the ceiling and between food.

Notice

- Because slide cases cannot guarantee the quality of foods that easily freeze (such as tofu, konjac, raw eggs, vegetables, etc.), storing such foods is not suitable. Depending on the type and amount of food, as well as its condition at the time it is placed in the refrigerator, food may freeze.
- The temperature of the lower case (when Supercool chilling is set) may change and exceed 0°C.

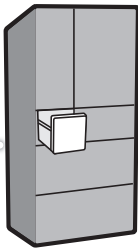

Compartment Introduction

Ice Making Compartment

If water is put into the refrigerator compartment's water tank, ice will be made in the ice making compartment.
Clean the ice maker periodically to ensure that the ice is pure and delicious. ➔ Pages 26 - 27

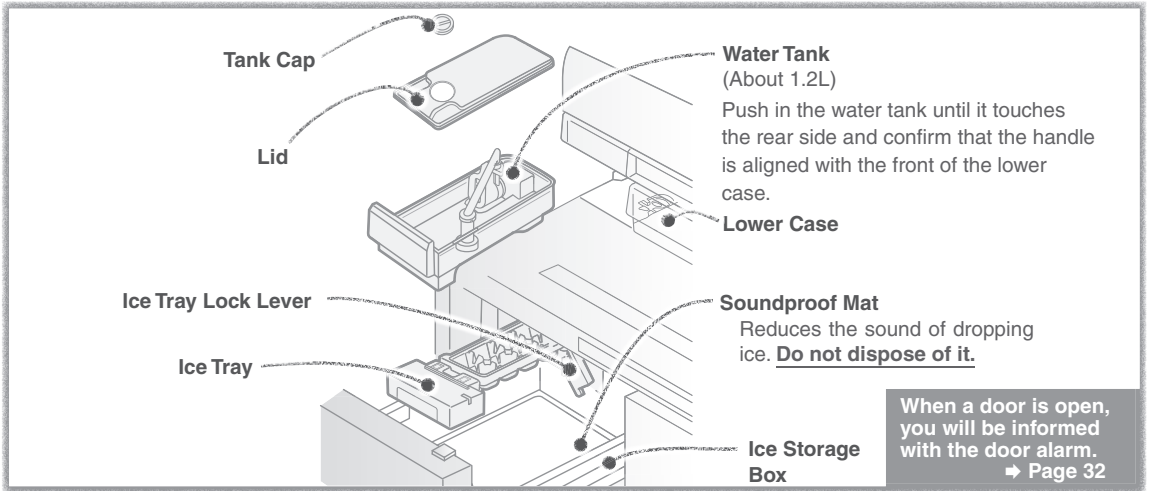

Making Ice

Wash the water tank, water supply pipe, and ice tray before making ice for the first time, or if you have not made ice for more than a week.

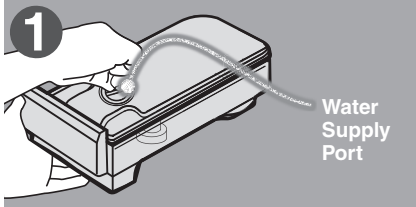

Remove the water tank from the refrigerator compartment, remove the tank cap by twisting it, and supply water.

Do not pour water above the full position (▲).

- Water will easily spill when you carry the tank. Further, it may cause the ice to join together or form a protrusion.

*WARNING-Fill with potable water only.

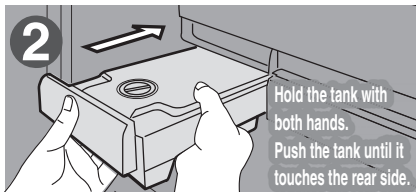

Close the water tank cap and return the water tank to its original position.

- Push in the water tank until it touches the rear side. Setting the water tank incorrectly may prevent ice from forming.

Tips

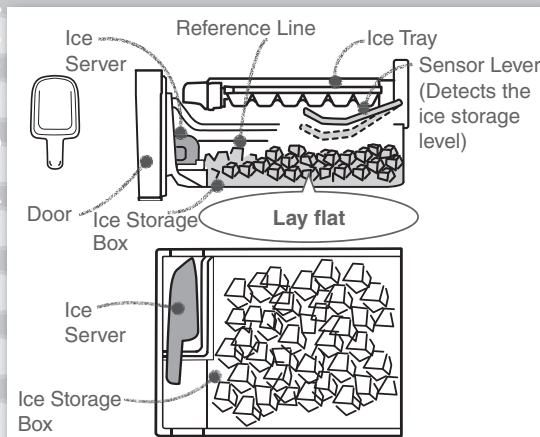



- Set the ice making compartment to "STOP" mode when storing food in it. Store food lower than the reference line of the ice storage box (otherwise it may cause an ajar door, malfunction or damage). ➔ Pages 21 - 22
- Do not pour anything other than cold water into the water tank, such as warm water, juice, tea, soft drinks, or other liquids (the tank can resist heat up to 60°C).
Pouring anything other than cold water into the tank may cause damage.
- Do not pour water directly into the ice tray to make ice. Unfrozen water in the ice tray may fall into the ice storage box, and the ice may join not forming cubes.
- Do not place objects at the rear of the ice storage box.
- The level of the ice storage is checked automatically by the sensor lever, and ice making is stopped when the ice reaches a certain level (about 70 to 140 ice cubes). To detect the ice storage level correctly, make sure that the ice is flat and that the ice server is kept in its storage position in the front of the ice storage box as shown in the left diagram.

Quick Ice Making

RAPID ICE (Quick Ice Making)

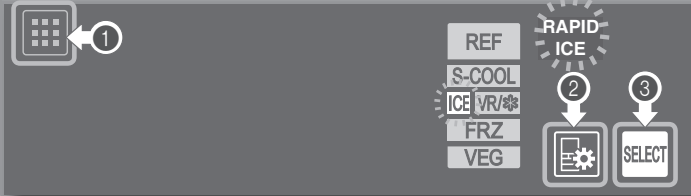
The ice making time for a single batch can be shortened.





- 1 Touch  on the operation panel
- 2 Repeatedly touch  to display  → Pages 21 - 22
- 3 Repeatedly touch  to light up .

The display changes each time the button is touched.



The settings are finished.

- To cancel RAPID ICE, select  or .
- In the following cases, quick ice making is stopped automatically, and regular ice making will begin.
 - When about 10 hours have passed since the quick ice making is set.
 - When the ice storage box is full (about 70 to 140 ice cubes)
 - When there is no water in the water tank
- The sound of the refrigerator running gets louder during RAPID ICE, because it is operating at high speed. Also, the ice may split or crack because it freezes in a short time.

ICE

How Much Time Does It Take to Make Ice?



Ice making time will differ according to ice making compartment settings. Regular ice making is set at the time of purchase.

Operation Panel Display	Setting	Ice Making Time for 1 Batch
ICE	Regular Ice Making	About 2 hours
RAPID ICE	Quick Ice Making	60 to 80 minutes
ICE STOP	Ice Making Stopped	Ice will not be made.

To switch between , , and  → Page 22.

- In addition to the surrounding temperature, water type, and water volume and temperature in the water tank, ice making times may vary with the following conditions, and be longer than those in the table.
 - In winter or at other times when the surrounding temperature is low
 - When the door is often opened and closed
 - When the freezer compartment is set to "L"
 - When Energy Saving Mode is set → Page 20
 - When the ice tray is pulled out and reinserted during ice making
- When  is displayed, ice cannot be made. Cancel the setting. → Page 24

About the Ice

- About 10 to 12 ice cubes can be made each time. The ice cube size and the number of ice cubes in one batch depend on various factors, such as the amount of water in the water tank. When few ice cubes are being made, pour water into the water tank.
- When ice is made using water with a high mineral content, such as mineral water, white deposits (white crystals) may form in the ice. This is the crystallized mineral content and is not harmful.

- If the ice is stored inside the ice storage box for a long time, ice cubes may join together or shrink (due to a phenomenon called sublimation).



Caution

Be careful when breaking apart ice stuck in the ice storage box.

There is a risk of injury.

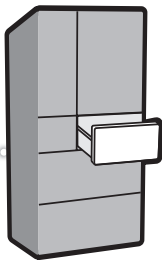

Compartment Introduction

Versa Compartment

The versa compartment can be switched between “Soft-Freezing” and “Freezer.” Placing food in the versa compartment and using “S-COOL FREEZE” or “HOT FREEZE” mode allows food to be frozen without losing its taste and texture.

Soft-Freezing / Supercool Freezing → Pages 16 - 18

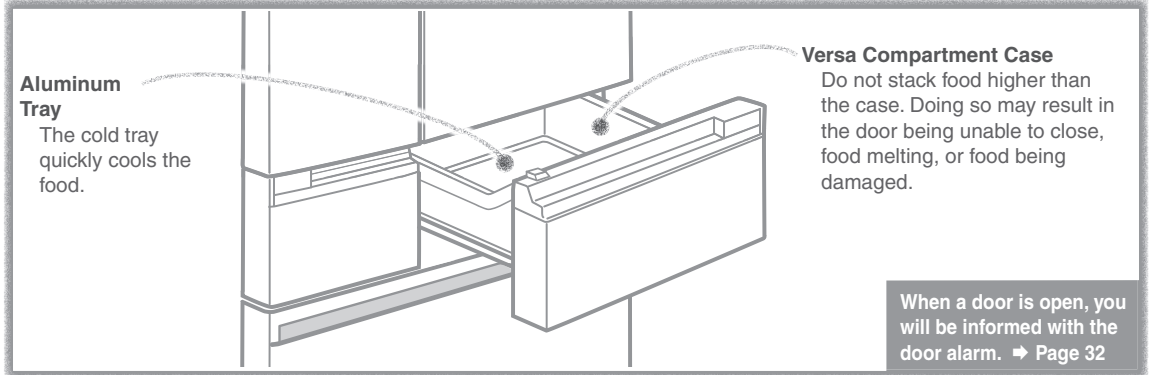

What can the versa compartment do?



The temperature in the versa compartment can be adjusted by switching between Soft-Freezing and freezing. With Soft-Freezing, to freeze food, use . For freshly cooked rice or other warm food, use .

Performing temperature adjustment

→ Pages 21 - 22

Operation Panel Display	Versa Compartment Condition
	Soft-Freezing Food can be cooked immediately after being taken out. Meat, fish, etc. can be stored for 2 to 3 weeks. This is set at the time of purchase. With and , food can be frozen even more deliciously.
	Freezing Meat, fish, etc. can be stored for about 1 month. For storing ice cream and frozen foods, use “FRZ•H”.

To supercool freeze foods such as meat, fish, and dessert



Supercool freezing



1



2



3

When Soft-Freezing is set

Foods such as meat, fish, and dessert can be deliciously frozen. Place food in the versa compartment before setting.

To Set

1 Touch on the operation panel

2 Touch

The letters above the icon will light up.

3 Touch

The settings are finished.

This ends automatically after about 8 hours.

After it ends, the food will be stored in Soft-Freezing mode.

Selecting will cancel .

To cancel in the middle → Page 9





Hot freezing

Hot or warm cooked foods such as freshly cooked rice, curry, and sauces can be deliciously frozen.

It can also be used to cool the food just after cooking.

Place food in the versa compartment before setting.

To Set

① Touch  on the operation panel

② Touch 

The text above the icon will light up.

③ Touch 

The settings are finished.

This ends automatically after about 9 hours.

The letters above the icon will light up until it ends.

After it ends, the food will be stored in Soft-Freezing mode.

Selecting  will cancel .



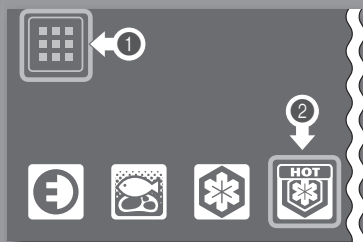
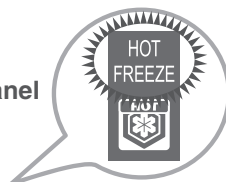

To Cancel ➔ **Page 9**





When Soft-Freezing is set

S-COOL

Tips

- With  “Supercool freezing” and  “Hot freezing” (both referred to as “supercool freezing”)...
 - At times such as storing new food, please set  or  again, and reduce the opening and closing of the doors as much as possible.
 - If you want to store food frozen with supercool freezing for a long time, move it to the freezer compartment quickly. Because food moved to the freezer compartment will freeze and harden, please thaw out food before using it.
 - Please do not store food that is hotter than 80°C.
- With Soft-Freezing...
 - When you have frozen a food too hard, leave it at room temperature for about 5 to 15 minutes. It will become easy to cut.
 - Adjust the temperature according to how the food is frozen. ➔ **Pages 21 - 22**
 - If the temperature setting of food is switched from freezing to Soft-Freezing, the food should be consumed as soon as possible (within 1 to 2 weeks).
 - Even if fruit is thawed, it does not return to its original condition. Eat frozen fruit without thawing it.
 - If fruit is stored for more than a week with Soft-Freezing, its taste may change. We recommend eating within 2 to 3 days.

Notice

- Supercool freezing cannot be performed during Power Save Mode.
- When performing operations with  or  in ②, if a continuous beeping sound occurs and the setting cannot be performed, the temperature setting is set to “Freezing.”
It can be set when Soft-Freezing.
- You can use supercool freezing even when other foods are still inside.
- Even after supercool freezing has finished, the food may not be completely frozen. (When the temperature is set to supercool freezing or Soft-Freezing, because food is frozen at about -7°C, it may take about 24 hours for the food to freeze completely.)
- The degree of freezing or freezer burn may vary depending on the food type, cooking method, storage arrangement (stacking, storage location), the amount of food, and the storage time.
- Depending on how much sugar, salt, moisture, or fat the food contains, freezing may not be possible or the food may harden when frozen (cannot be cut immediately with a kitchen knife).
- Use  with food that is close to body temperature.

Freeze foods with their original flavors. The frozen foods do not have to be thawed before being consumed.

Food can be frozen, while preserving its taste and texture.

Supercool freezing

Significantly reduces dripping during thawing and the loss of nutrients, preserving flavor

Prevents meat drip



Cut steak meat and blocks of meat into 100 to 200 grams and use "Supercool freezing" prevent dripping and preserve the taste and nutrients of food through supercool freezing.

Hot freezing

Things unsuitable for freezing such as potatoes and bamboo shoots can be frozen



You can batch cook

Use "Hot freezing" to keep potatoes in curry fresh. Just thaw the curry out for that fresh-cooked potato texture. There is none of the bother to remove potatoes before freezing them.

Hot freezing

Freshly cooked rice can also be frozen while hot



keep savory taste

Use "Hot freezing" to preserve the flavor of freshly cooked rice. Thaw it to enjoy its glutinous texture.

Since food can be easily cut even when frozen, it can be cooked without thawing.

Meat

Ground meat / Blocks of meat

It can be cut with a kitchen knife easily without thawing. Because it can be cut while frozen, whatever you will not use can be returned to the versa compartment. Food can be used without being wasteful.

Only the necessary amount



Thinly sliced meat / Bacon

You can easily separate them one by one and slice them finely without thawing. They will thaw while basting.

You can easily slice them.



Fish

Cutlets

You can easily separate them. No need for dividing them by the amount per serving before freezing. Purchased packs can be frozen as-is. Bake them at low heat without thawing and there is no trouble.

You can easily separate them.



Sauces

Meat sauce

If there is sauce left over, place it in a storage container and use "Hot freezing" Scoop out only the necessary amount and dress the pasta with it to easily make a meat sauce pasta.

Scoop the amount you need



Freezer Compartment and Versa Compartment: Using them properly



Versa Compartment
(Soft-Freezing setting)

Freezer Compartment

Make a large batch of simmered foods that are delicious when cooked in a large batch, then use "Hot freezing" on the excess amount. Move the supercool frozen food to the freezer compartment to preserve for a long period of time. This can also save the time and labor of cooking every day.

* Meat and fish can be preserved in a freezer compartment for about 1 month, but the preservation period will differ according to the freshness of food before storing it.



Freezer Compartment

Versa Compartment
(Soft-Freezing setting)

This is recommended for when you would like to consume food without thawing.

Food that has been moved to the versa compartment (set to Soft-Freezing) can be cut to just the portions necessary, so food is not wasted.

Although this differs depending on the size of the food, most food can be cut in about 2 to 5 hours.

* Use food within a short period of time (about 1 to 2 weeks).



Soft-Freezing / Supercool Freezing

Handy Tricks for Supercool Freezing



Convenient Preservation

Can preserve for 2 to 3 weeks
Plus it is easy to use

Whitebait

Because it is frozen in a crumbly state, you can scoop out just as much as you need with a spoon.

Cod Roe / Squid Salted Fish-guts

At -7°C, food containing a large amount of salt will not freeze. It can be eaten right out of the refrigerator.



Boiled vegetables

Keep boiled vegetables together with

 "Hot freezing." The vitamins of the boiled vegetables will keep even after thawing, making for a tasty meal.



* The preservation period will differ according to the food type and the condition of the food when it is placed in the freezer compartment.

Easy to Cut

Raw food that is difficult to cut can be easily cut

Lemon Slices

Slicing extremely thin lemons is very easy!



Squid

Even slippery difficult-to-cut squid can be cut easily.



Carpaccio

Red sea bream and Tuna can very thinly be sliced. It can be prepared deliciously.

Easy to Make Meals

Make meals quickly when you are busy in the morning

Karaage / Teriyaki

If you use  "Supercool freezing" on meat marinated in seasoning liquid such as karaage or teriyaki chicken meat, you can use just as much as you want whenever you want.

Easy Desserts

Enjoy fruit with a new texture

Frozen fruits

Cut fruits into bite-size pieces and use  "Supercool freezing" on them for fruit sorbet. Try it out on a variety of fruits.



Sweet fruits are recommended

Tips for Supercool Freezing



Put Foods at the Same Time.

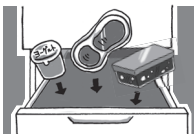

If more food is added in the middle, the supercool freezing may not work.
Separate hot food from frozen food. The hot food may touch and thaw the frozen food.

Lay the Food out Flat on Top in the Versa Compartment.



Place food level and side by side.
Do not store in a glass container. It may break.

Foods Unsuitable for Supercool Freezing

● Foods that cannot be frozen (Konjac (devil's tongue), tofu, milk, raw eggs, etc.)

Preservation of the pre-freezing texture and quality cannot be guaranteed.



● Groceries like frozen foods and ice cream.



● Food that has already thawed once

The texture and quality cannot be guaranteed.

Soft-Freezing / Supercool Freezing (Continued)

Easy Dessert Recipes with Supercool Freezing

Strawberry and Kiwi Fresh Jam

Ingredients (For an easy-to-make amount)

Strawberries	1 Pack (About 300g)
Kiwis	4 to 5 (About 300g)
Sugar	60g to 100g
	(Respectively for the strawberries and for the kiwis)



Procedure

- ① Remove strawberry stems and peel off kiwi skin.
- ② Place the ingredients from ① in separate bowls and carefully mash them.
- ③ Add sugar according to the desired sweetness, then use ☒ "supercool freezing"
- ④ After leaving it overnight, it's ready. Scoop out the amount you'd like to use.

Important Point!

Because no heat is used, it is very easy to make and produces beautiful colors. Also, because it can be made with a small amount of sugar, it is very healthy. It can even be casually made in small amounts when you have left-over fruit.

Green Smoothie

Ingredients (1 serving)

	Frozen with ☒ "Supercool freezing"
Boiled cabbage	About 1 leaf (About 50g)
Boiled spinach	About 1 root clump (About 30g)
Peeled apple	1/2 apple
Yogurt (no sugar)	1/3 cup

Honey 1 tablespoon

Procedure

- ① Cut the frozen cabbage, spinach, and apples while still crunchy, and put in a mixer together with all other ingredients.



Important Point!

Vegetables and fruits frozen with supercool freezing are broken up by the mixer very quickly.

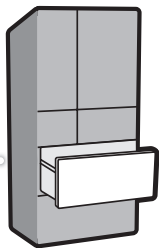

Compartment Introduction

Freezer Compartment

Store frozen food and ice cream. Store bread, meat, and fish through freezing.

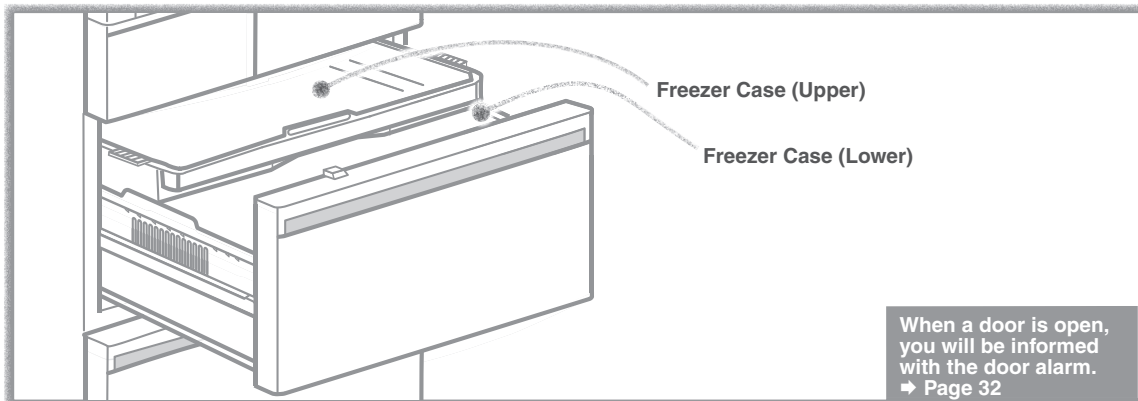

Freezer Case (Upper)

Freezer Case (Lower)

When a door is open, you will be informed with the door alarm. → Page 32

Tips

- Do not place tall objects in the freezer case (lower).
Food or the freezer case (upper) may become damaged or the door may not close, causing the accumulation of frost or lowering the cooling performance.
- Do not put in plastic drink bottles other than those meant for freezing.
The frozen contents may break the bottle.

S-COOL

FRZ
VEG

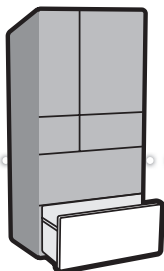

Compartment Introduction

Vegetable Compartment

Place vegetables, fruits, and beverages in this compartment. It preserves food, maintaining the moisture that would normally go away over time. Storing fruits and vegetables in plastic wrap keeps them even fresher.

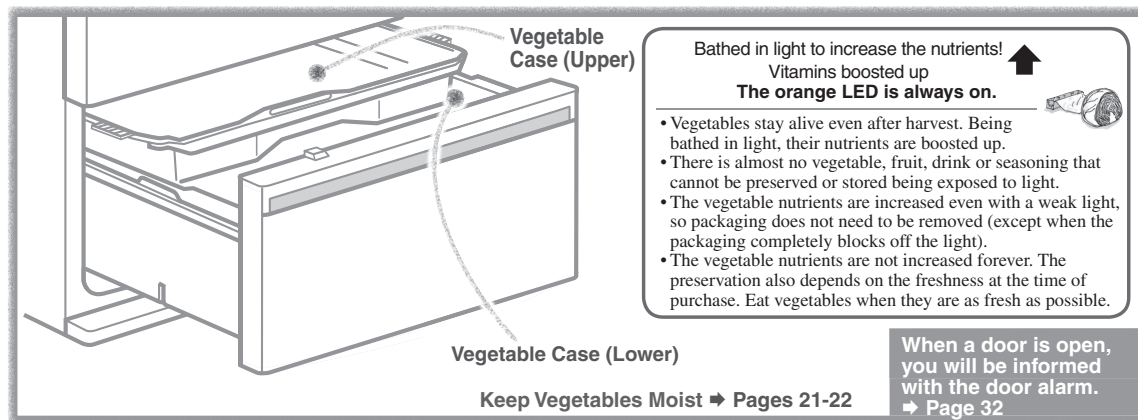

Vegetable Case (Upper)

Vegetable Case (Lower)

Keep Vegetables Moist → Pages 21-22

Bathed in light to increase the nutrients!
Vitamins boosted up
The orange LED is always on.



- Vegetables stay alive even after harvest. Being bathed in light, their nutrients are boosted up.
- There is almost no vegetable, fruit, drink or seasoning that cannot be preserved or stored being exposed to light.
- The vegetable nutrients are increased even with a weak light, so packaging does not need to be removed (except when the packaging completely blocks off the light).
- The vegetable nutrients are not increased forever. The preservation also depends on the freshness at the time of purchase. Eat vegetables when they are as fresh as possible.

When a door is open, you will be informed with the door alarm. → Page 32

Tips

- Do not pile food higher than the height of the vegetable case (lower) or vegetable case (upper).
Food or the vegetable case (upper) may become damaged or the door may not close, causing the accumulation of condensation or lowering the cooling performance.
- Because the vegetable compartment has a high humidity depending on the amount or types of vegetables, frost or condensation may form on the roof of the vegetable compartment or the surface of the cases. When condensation forms, wipe it off with a dry cloth.

Energy Saving Mode



This mode learns each family's method of use and operates with the optimal state for each compartment.



Energy Saving Mode

An appropriate timing is selected for each compartment and the energy saving mode is performed automatically with a slightly high temperature setting.

To Set

- 1 Touch  on the operation panel
- 2 Touch 

The text above the icon will light up.
- 3 Touch 

The settings are finished.

To Cancel the Setting → Page 9

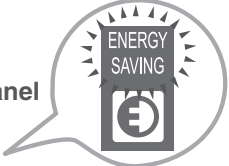

To Confirm with the ECO GUIDE

The refrigerator's ECO level for the last 24 hours is indicated by the number of ★ marks judged from such things as the temperature settings in each compartment and the frequency of opening and closing the doors in "how to use, etc."

Operate the Operation Panel

The compartment display switches each time  is touched.
 You can confirm which compartments are in energy saving mode with the **ECO** display.

Example: When the freezer compartment and the refrigerator compartment are in energy saving mode (ECO level 3)

Display example	★ ★ ★	★ ★ ★ ECO	★ ★ ★	★ ★ ★ ECO
Compartment display	REF	REF	REF	REF
	S-COOL	S-COOL	S-COOL	S-COOL
	ICE VR/★	ICE VR/★	ICE VR/★	ICE VR/★
	FRZ	FRZ	FRZ	FRZ
	VEG	VEG	VEG	VEG

Close the Door

After a door is closed, the ECO GUIDE and  will light up (after about 30 seconds it will turn off).

Example: When the refrigerator compartment and the freezer compartment are in energy saving mode

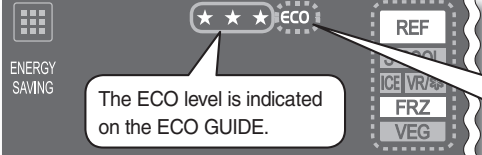

When Energy Saving Mode is set, the compartment in energy saving mode will light up with **ECO**.

The ECO level is indicated on the ECO GUIDE.

When Energy Saving Mode is set, the compartment in energy saving mode will light up with **ECO**.

ECO Lights-Out

In the following cases, energy saving mode will be cancelled and the light will turn off.

- When the doors are frequently opened and closed
- When RAPID COOL is operating
- After defrosting

(After the freezer compartment is sufficiently cold and stable, energy saving mode will automatically restart.)

How to View the ECO GUIDE

ECO level	Operation Panel Display
Level 3	★ ★ ★
Level 2	★ ★
Level 1	★
Level 0	★ — blinking

- At the time of purchase, level 1 is displayed.
- If energy is being saved, the ECO level will increase (it is updated about once every hour).
- The ECO GUIDE is displayed even when Energy Saving Mode is not set.

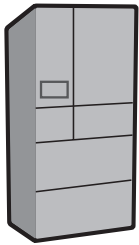

Detail Setting

Performing Temperature Adjustment

The temperature of each compartment can be adjusted.
 Use the refrigerator, freezer, and vegetable compartments set to "M" usually.
 Use the versa compartment in your preferred setting.

Temperature Adjustment

At the time of purchase, the settings are as follows.

Refrigerator, Freezer, and Vegetable Compartments
 "M"
 Versa Compartment
 "SOFT FRZ M"



This is a display example of when the versa compartment is set to "SOFT FRZ M."

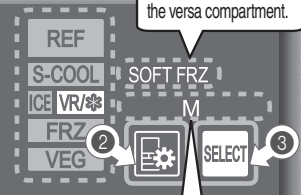

This is displayed when setting the temperature of the versa compartment.

L • M • H

The set temperature lights up.

- 1 Touch on the operation panel
- 2 Repeatedly touch to light up the compartment that you want to set the temperature for.
 The display changes in the order shown in the right each time the button is touched.
 is displayed at the time of purchase.
 When a compartment is displayed, that compartment's temperature setting will also be displayed.
- 3 Repeatedly touch to set the temperature.

In 2 and 3, touching or not performing any operations for about 30 seconds will return the display to its initial state. →Page 8

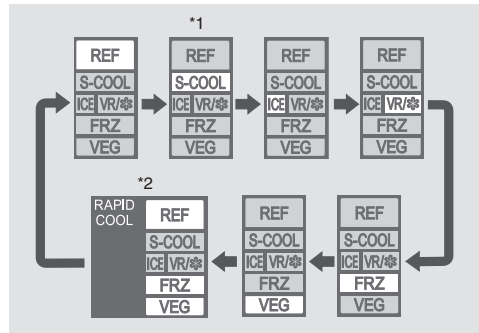

*1 Can only be selected when Supercool chilling is set.

→Page 11

*2 When set to RAPID COOL

→Page 23

ENERGY SAVING

Temperature Adjustment

Refrigerator/Freezer Compartment Temperature

The display changes each time is touched and the temperature can be set to 5 different levels.

Compartment	REF	FRZ
	About 6°C	About -16°C
	About 5°C	About -17°C
	About 3°C	About -19°C
	About 1°C	About -21°C
	About 0°C	About -22°C

High
Average
Low

The freezer compartment temperature is different from the freezing temperature of the versa compartment.

Lower Case (When Supercool chilling is set) Temperature

Can be adjusted to only when Supercool chilling is set.

→Page 11

Make this setting when food freezes.

The display changes each time is touched.

Operation Panel Display	Application
	Normally
	When food freezes When the surrounding temperature is 5°C or less

Performing Temperature Adjustment (Continued)

Ice Making Compartment Settings

The display changes each time **SELECT** is touched.

Operation Panel Display	Application
ICE ↓ ↑	When you want to make ice
RAPID ICE ↓ ↑	When you want to make ice quickly
ICE STOP	When not using the refrigerator for a long time For cleaning When you want to use as a freezer compartment

When you want to make ice quickly (RAPID ICE)

➔ Page 13

For short term storage of frozen food. Not to be used for long term storage of frozen food or ice cream.

Vegetable Compartment Temperature Settings

The display changes each time **SELECT** is touched and temperature can be set to 5 different levels to keep vegetables moist.

Compartment Operation Panel Display	VEG	
L ↓ ↑	About 9°C	High Average Low
L ● ↓ ↑	About 8°C	
M ↓ ↑	About 6°C	
● H ↓ ↑	About 5°C	
H ↓ ↑	About 3°C	
● ● ↓ ↑	Keep Vegetables Moist	

When keeping vegetables moist, the vegetables can be freshly kept for a long time in the temperature suitable for cooling leaf vegetables.

Versa Compartment Temperature

The display changes each time **SELECT** is touched and the temperature can be set to 6 different levels.

Operation Panel Display	Compartment VR/❁	Application
SOFT FRZ	L ↓ ↑ About -5°C	For preserving food containing a lot of moisture Large blocks of low-fat meat For food that is frozen too hard and difficult to cut
	M ↓ ↑ About -7°C	The optimum temperature for Supercool Freezing The food is easy to cut even when frozen. Packs can be frozen as-is.
	H ↓ ↑ About -9°C	For preserving food containing a lot of salt or sugar For food that is difficult to freeze
FRZ	L ↓ ↑ About -12°C	For preserving food containing a lot of salt or sugar
	M ↓ ↑ About -15°C	For preserving food that was frozen at home
	H ↓ ↑ About -18°C	For preserving frozen food and ice cream that were purchased

The freezer compartment temperature is different from the freezing temperature of the versa compartment.

After changing from freezing to Soft-Freezing, it takes some time for the temperature inside the refrigerator to stabilize (about 2 hours).

Notice

- The temperatures described here are measured in the lower centre of the refrigerator after the temperature has stabilized when the surrounding temperature is 30°C and the doors are closed without any food inside. The temperature fluctuates with factors such as food storage conditions and how often the doors are opened and closed.
- Before and after defrosting, the temperature inside the refrigerator may drop or rise temporarily.
- When food freezes in the refrigerator compartment or lower case, set the refrigerator temperature setting to **M** - **L** and the lower case temperature setting (when Supercool chilling is set) to **L**.

RAPID COOL







When storing a large amount of food, protect the food's freshness by rapidly cooling it.

When set: Blinking→Light on
When cancelled: Light on→Blinking

RAPID COOL

Swiftly cool compartments (Refrigerator, Freezer, and Vegetable Compartments) when their doors are opened and closed

To Set







- 1 Touch  on the operation panel
- 2 Repeatedly touch  to display  → Page 21
 will blink.
- 3 Touch 
 will change from blinking to staying lit, and then the setting is finished.

This ends automatically about 2 hours after setting.

It doesn't matter whether you put food in before or after the settings.



To Cancel in the Middle

- 1 Touch  on the operation panel
- 2 Repeatedly touch  to display  → Page 21
 will light up.
- 3 Touch 
 will change from lit to blinking, then will be cancelled.

Temperature Adjustment

RAPID COOL

Notice

- The sound of the refrigerator running gets louder during RAPID COOL, because it is operating at high speed.

Power Save Mode

The cold air in unused compartments is saved, allowing energy to be positively saved.

Power Save Mode

This function reduces freezing capability of the ice making compartment and versa compartment for the purpose of power saving.

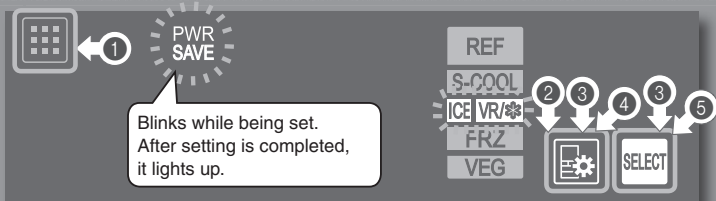

Blinks while being set.
After setting is completed,
it lights up.

If the ice making compartment is set to Power Save Mode, ice making will stop and ice will no longer be able to be stored. Empty the water from the water tank as well as the water and ice from the ice tray and the ice storage box. ➔ Pages 26 - 27

To Set

- 1 Touch on the operation panel
- 2 Repeatedly touch to light up ICE or VR/*.
- 3 Touch and at the same time for at least 3 seconds until the buzzer sounds.
 will blink.
- 4 Repeatedly touch to light up the compartment to set
The lit compartment is set to Power Save Mode.
The display changes in the order shown in the right each time the button is touched.
 - represents a blinking display.
 - Power Save Mode is disabled at the time of purchase.
- 5 Touch
The buzzer will sound and will change from blinking to staying lit, and then the setting is finished.
If the ice making compartment is set, is displayed.
* If 30 seconds pass without touching , the display will return to 2 without performing any settings.

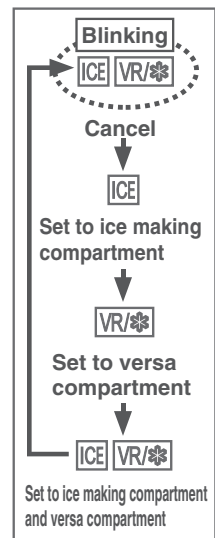

To Cancel the Setting

Example of when cancelling Power Save Mode for the ice making compartment

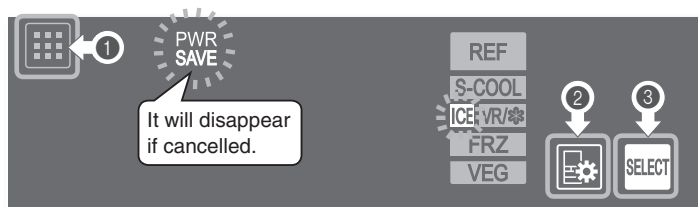

It will disappear if cancelled.

- 1 Touch on the operation panel
- 2 Repeatedly touch to light up the compartment to cancel
- 3 Touch
 goes off when the setting is cancelled.

The setting will also be cancelled during the procedure to enable the setting if the step 5 is performed while and are blinking in the step 4.

Food that Can be Stored in Power Save Mode

In Power Save Mode, food will be preserved between about -10°C and 0°C, so it is well suited to the preservation of foods such as dry goods and grains.

Dry goods.....Coffee beans, seaweeds, nuts, dry noodles (pasta, vermicelli, fine noodles, etc.) etc.

Seasonings.....Salt, sugar, spice powder, etc.

Grains.....Rice, wheat, potato starch, etc.









Confectioneries and cakes.....Dry confectioneries, chocolates, cookies, etc.

Functions that Cannot be Used in Power Save Mode

There are functions that cannot be used when the refrigerator is set to Power Save Mode.

Unusable functions will not light up on the operation panel and will not be operational. To use these functions, cancel

Power Save Mode before operation. ➔ Page 24

Compartment set to Power Save Mode	Versa Compartment
Functions that Cannot be Used	 Supercool freezing  Hot freezing
Operation Panel Display  indicates that it is not lit. Icons that are not lit cannot be used.	    

Successfully Saving Power

Open and close doors as quickly as possible

If doors are opened frequently or are kept open for a long time, cold air escapes and more power is consumed.



Do not cover up air outlets or air inlets

Blocking the flow of cold air can make it difficult for food in the refrigerator to cool down. The temperature around the air outlets can drop, making foods with significant moisture freeze easily.



PWR
SAVE

Don't cram too much food into the fridge

If too much food is crammed into the refrigerator, the flow of cold air can deteriorate, making it difficult for food to cool down.



Cool hot foods before placing them inside

Placing hot foods in the refrigerator will lower the temperature, also affecting the freshness of other foods. (excluding Hot freezing)



Tips

- In Power Save Mode, it is not suitable to store ice, fresh food, frozen food, ice cream, and food frozen at home. Move food from the versa compartment to the freezer compartment in advance.
- Check the items in the compartment before setting.
- When placing food in the ice making compartment, store food below the reference line of the ice storage box (because it may cause an ajar door, malfunction, or damage).

Notice

- Temperature may be lower when the ambient temperature is low, such as during winter, or when the freezer compartment is set to high.

Cleaning the Automatic Ice Maker

To prevent the growth of limescale and mold, clean periodically. Do not use a dishwashing machine, because it may deform the parts. Do not use the following for cleaning.

- Items such as sponges or scrubbers that may damage surfaces
- Cleaners such as alkaline detergents, scouring powder, boiling water, petroleum, or acid

Once a week Water Tank / Water Supply Pump

If mold forms easily in certain types of water, clean about 2 or 3 times a week.

* When not making ice, remove the water.

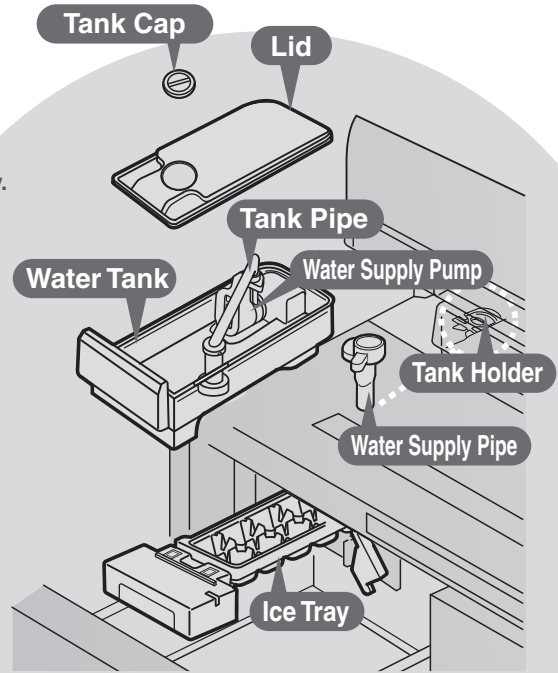

1 Remove the water tank, remove the lid, and wash it.

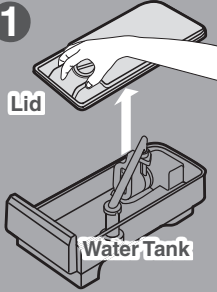

Remove the tank cap by twisting it.

When using bleaching agents to clean the water tank and lid, follow the instructions of the agents.

2 Pull out the tank packing from the water tank.

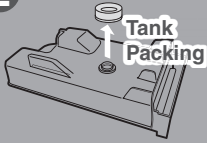

3 Pull out the tank pipe and rotate and remove the water supply pump.

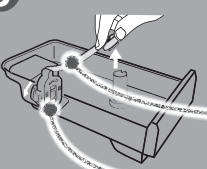

Wash the water tank.

Water Supply Pump

4 Disassemble the water supply pump and wash it.

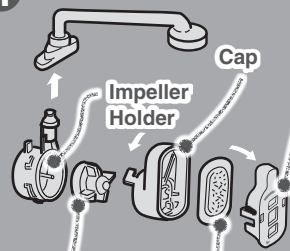

Remove the cap lid while opening the tab.

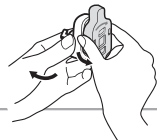

Impeller
The impeller is made from a magnet. Wash it thoroughly to remove any foreign objects.

Leadcleaning Filter
Wash by lightly rubbing.
*Do not use cleaners such as kitchen detergents (neutral), benzene, or bleach. Doing so may result in odors of the ice.

5 Assemble the water supply pump.

1 Fit the filter onto the cap.



2 Fit the cap lid onto the cap.

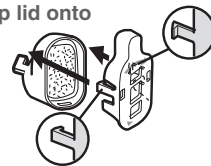

3 Attach the impeller to the impeller holder.

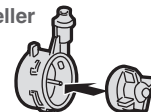

4 Rotate and fix the tab (1) of the cap into the projection (2) on the impeller holder.

Make sure that the impeller is inside.

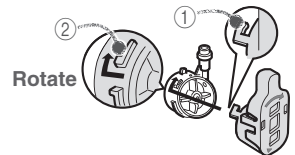

5 Rotate and set the water supply pump onto the water tank.

Align the triangle mark on the bottom of the water tank with the triangle mark on the cap lid and push in while making sure that there is no gap.

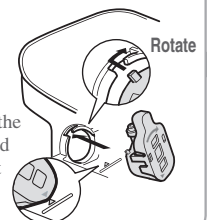

Once a month Water Supply Pipe and Tank Holder

1 **Water Supply Pipe**

Pull out the water supply pipe and wipe the tank holder with a clean cloth.

Do not pour water into the tank holder. Doing so may cause a malfunction.

Tank Holder



2

Disassemble and wash the parts.

Twist and remove the water supply pipe.

White minerals or chlorine accumulation may adhere to the parts, this is not abnormal. Wash off such substances and reuse the parts.

Easier to disassemble/assemble when wetted



3 **Water Supply Pipe**

Follow the procedure in reverse to return the parts to their original positions.

Push in the water supply pipe firmly so there are no gaps.

If there are gaps or looseness, it may cause a malfunction.

Tank Holder

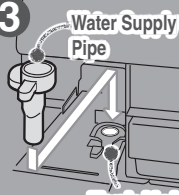

4 **Tank Packing**

Check whether there are any foreign objects between the water supply pipe, tank packing, and tank holder.

Insert it horizontally so that there are no gaps.

Failing to do so may cause noises to occur, ice to not freeze, and may also cause the water in the water tank or food in the refrigerator compartment to freeze.

Horizontally

So that foreign objects do not get inside

Water Supply Pipe



1 to 2 times a year Ice Tray

Before cleaning, make sure to set "Stop Ice Making." → Pages 21 - 22

1

Open the door of the ice making compartment and unlock the ice tray lock lever.

Ice Tray Lock Lever

ICE TRAY will appear on the operation panel.

If the alarm sounds continuously when the ice tray lock lever is unlocked, lock the lever, close the door, wait for the blinking **ICE** to turn off, and then try again.

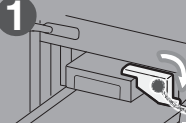

2

Pull the ice tray towards the front and then remove it.

There is a risk of the water spilling. Pull out the tray slowly.

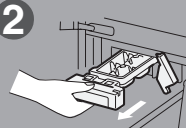

3 **Empty the ice tray and wash it.**

After washing the tray, dry off any moisture.

4 **Attach the ice tray.**

Push in the ice tray until it makes a clicking sound, and then lock the ice tray lock lever.

ICE TRAY will disappear. If the lamp does not disappear, check the position of the ice tray lock lever and the up and down orientation of the ice tray.



When making ice, set the ice making compartment's setting to **ICE**. → Pages 21 - 22

Notice

- If the water supply pipe and tank packing are not installed, they may cause the water in the water tank or food in the refrigerator compartment and slide cases to freeze.
- Replacement is not usually required for the leadcleaning filter. However, it may require replacement in the following cases.
 - When it clogs because something other than water was put in the tank
 - When it has broken
 - When mold has grown

To purchase a new filter, contact the retail store where you purchased the refrigerator.

* If mold forms easily in certain types of water, clean about 2 or 3 times a week.

6 Install the tank pipe.

1 Insert the tank pipe into the water tank.

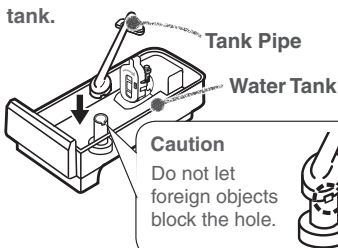

2 Connect the tank pipe to the water supply pump.

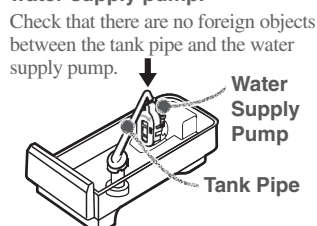

3 Install the tank packing

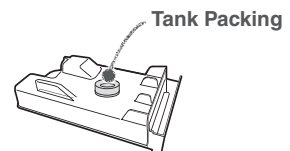

Cleaning Removing and Cleaning the Parts



Remove plug

Remove the power plug before cleaning.
Otherwise an electric shock or injury may result.



Prohibited

Do not disassemble, repair, or alter.
Do not use while parts are damaged.
Doing so may cause injury, electric shock, or fire.

* After cleaning, wait at least 10 minutes before reinserting the power plug into the socket.
If you insert the plug immediately, there will be an overload on the machine.

How to Clean Q&A



Q. What should I do if I notice the refrigerator is dirty?

A. Before the dirt becomes hard, wipe it off.

- Wipe with a soft cloth soaked in warm water.
- For stubborn dirt, wipe using water mixed with a weak concentration of kitchen detergent (neutral).
- Especially in the case of oil stains and citric fruit juice, wipe it off immediately.
- If dirty door packing is ignored, it can be damaged and cause cold air to leak. After wiping with a soft wet cloth, if there is still moisture, finish wiping with a dry cloth.

Q. Can the shelves, cases, and pockets be removed?

A. For information on which parts can be removed,
refer to ➔ Pages 29 - 30 .

Q. What should I do with doors and shelves made of glass?

A. Wipe with a soft cloth soaked in warm water.

- If a door or shelf made of glass has cracked or shattered, do not touch the broken glass, but contact the retail store where you purchased the refrigerator immediately.
- Magnets will not adhere to a glass door.

Tips

Do not use the following items.

Alkaline or low alkaline kitchen detergents, scouring powder, powdered soap, alcohol, benzene, thinner, petroleum, acid, scrubbers, boiling water, or similar substances.

Doing so may cause the plastic parts (such as the door handles, caps, cases, etc.) to split, or damage or rust the glass doors, shelves, or painted surfaces.



Power Plug

For safety, clean the power plug and cord periodically.

- 1 Remove the power plug from the socket.
- 2 Check for damage or abnormal heating on the power plug and cord.
- 3 Remove any dust from the power plug and surrounding area, and then wipe with a dry cloth.
- 4 Firmly insert the power plug into the socket.

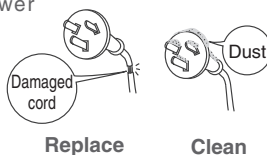

Replace

Clean



Follow the instructions

Remove dust periodically from the power plug.

Dust may cause insulation failure, resulting in fire.

Refrigerator Rear Side and Floor

This is a place where, because of the convection current of the air, dust tends to gather and can easily turn black. Also for the purpose of saving energy, clean periodically.

- 1 Remove the adjustable support cover.
- 2 Turn the adjustable supports to raise them from the floor, and pull out the refrigerator.
We recommend laying out protective material on the floor to prevent the floor from being damaged. Also, be careful not to injure yourself.
- 3 Remove dust from the refrigerator's rear side, the wall, and floor, and wipe off all dirt.
- 4 Check for water dripping on the floor.

Dust, etc.

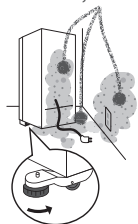

Prohibited

Do not put your hands under the refrigerator.

It may cause injury.

When attaching parts, use the backward procedures of removal.

Glass Shelf (Upper) (Middle) (Lower)

- 1 Lift the front of the shelf using both hands.
- 2 Pull out to the front.



- 3 Using the gap between the refrigerator compartment and door, rotate the glass shelf (upper) and remove from the refrigerator.

*The illustration is of the glass shelf (upper). Remove the glass shelves (middle) and (lower) in the same manner.

*Remove the glass shelf (lower), with the partition attached, after you have removed the glass shelf (middle) and slide glass shelf.

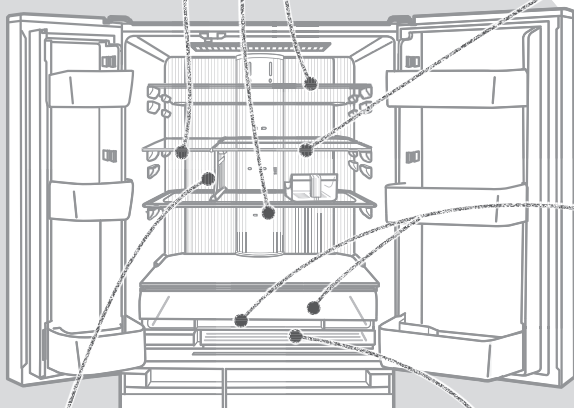

Partition

- 1 Remove the glass shelf (lower) and place it on a surface such as a stand.
 - 2 Press the glass shelf (lower) down with one hand.
 - 3 Pull in the direction indicated by the arrow.
- * The shelves are firmly installed.

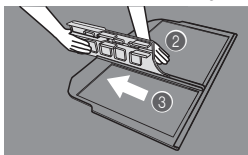

Lower Case

- 1 Fully pull out the lower case.
- 2 Lift the lower case out to the front.

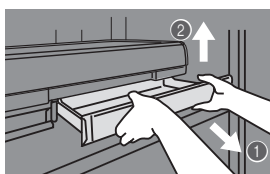

Follow the instructions

Be careful when attaching and removing the glass shelf.

If it is attached improperly, it could come loose and fall, causing injury.

Slide Glass Shelf (Front) (Back)

- 1 Remove the slide glass shelf (front) using the protruding parts in the front and back along with the grooved parts.

Protruding Part

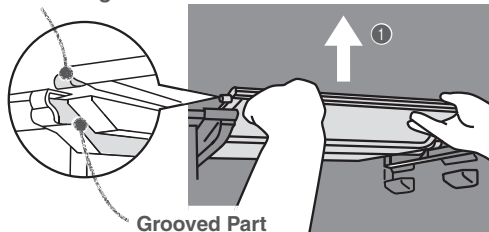

- 2 Pull the slide glass shelf (back) out to the front while holding the front with both hands.

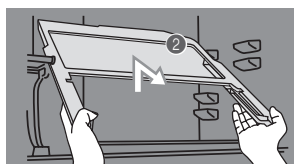

Upper Case / Upper Case Cover

- 1 Lift the upper case cover.
- 2 Press the position indicated with Δ on the right and remove.

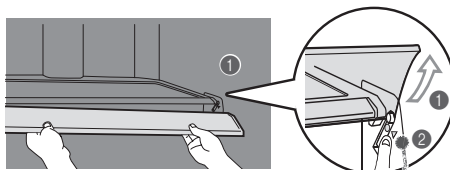

Δ position

- 3 Fully pull out the upper case and lift the front of the upper case until the bottom can be seen.

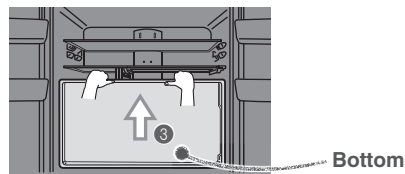

- 4 While tilting the upper case to your side, pull it out.

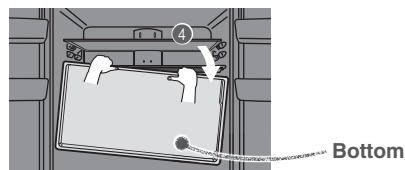

* When it is difficult to remove, remove the upper case after removing the adjustable pocket.

Cleaning

Cleaning Removing and Cleaning the Parts (Continued)

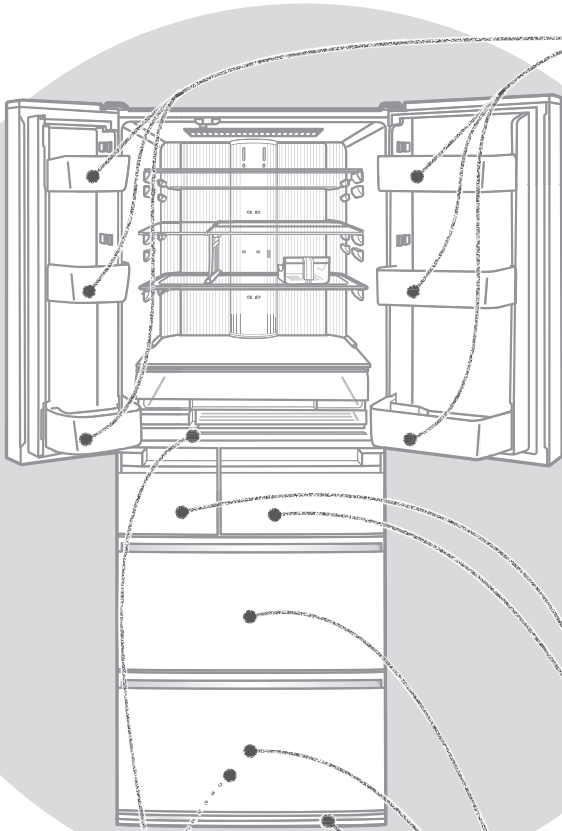

Adjustable Pocket (Large) (Small) / Bottle Pocket (Large) (Small)

- 1 Lift up the left and right of the pocket alternately.
* The pockets are firmly installed.
- 2 Pull out to the front.

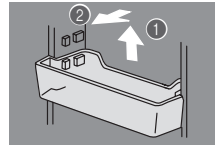

Adjustable Pocket

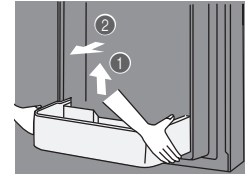

Bottle Pocket



Follow the instructions

Be careful when attaching and removing the pocket.

If it is attached improperly, it could come loose and fall, causing injury.

Recessed Portion of the Drip Gutters

Wipe off any dirt, dripping or condensation.

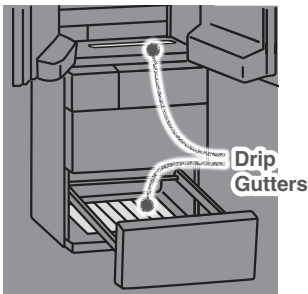

Ice Making Compartment and Versa Compartment Case

- 1 Fully pull out the door.
- 2 Lift the case out to the front.

* The illustration represents the versa compartment. Remove the ice making compartment in the same manner.

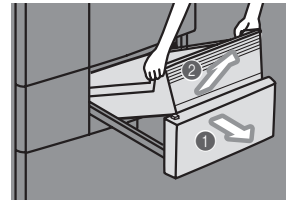

Freezer Compartment and Vegetable Compartment Case

- 1 Fully pull out the door.
- 2 Lift the upper case out to the front.

- 3 Pull out while slightly lifting up the door, and then tilt.
- 4 Lift the lower case out to the front.

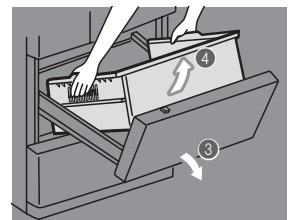

* The illustration represents the freezer compartment. Remove the vegetable compartment in the same manner.

Adjustable Support Cover

- 1 Pull the left and right sides of the support covers to the front to remove them.

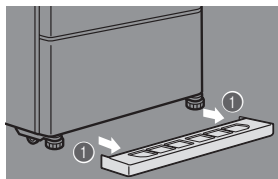



Other Issues (Power Outages, Child Safety Lock, Setting Reset, When **D** Lights Up)

Power Outages



- Minimize the frequency of opening the doors, and avoid adding more food.
- Operation panel settings other than the temperature settings may change. Check the settings. (Child Safety Lock, etc.)

To Prevent Accidental Button Operation (Child Safety Lock)

Locks the operation panel to prevent accidental icon operation by children.



- 1 Touch  for about 5 seconds or more when the door is closed (until the buzzer sounds).
 lights up when the setting is finished.
 - Setting cannot be changed during Child Safety Lock.

To Cancel







- 1 Again, touch  for about 5 seconds or more when the door is closed (until the buzzer sounds).
 goes off when the setting is cancelled.

To Reset Settings

Returns the settings to their initial conditions (at the time of purchase), for example if you have forgotten the settings.

- 1 Touch  to light up an icon.
- 2 Touch  for about 10 seconds (until the buzzer sounds twice).

The following settings will be reset.



- | | | |
|--|--|--|
| • Energy Saving Mode  | • Supercool chilling  | • Supercool freezing  |
| • Hot freezing  | • RAPID ICE  | • RAPID COOL  |
| • Power Save Mode  | | |

- The temperature setting of the versa compartment (Freezing and Soft-Freezing) does not change.
- The “ICE STOP” setting for ice making will not be reset.

When **D** Lights Up

When **D** lights up, the refrigerator is in demonstration mode. The refrigerator does not cool in this mode. Contact the retail store where you purchased the refrigerator, or cancel the demonstration operation with the following procedure.

To Cancel

- 1 Keep the doors of the versa compartment open.
- 2 Light up the icons and press , , and  at the same time for at least 5 seconds.
- 3 Check that **D** is turned off.
 - The demonstration mode was not cancelled if it lights up.

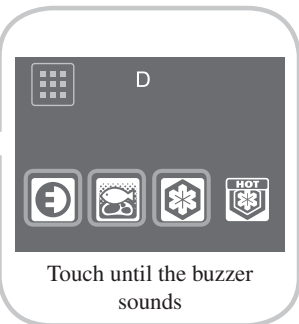

Cleaning

Trouble-shooting

Other Issues (Door Alarm, Mark, When Not Using the Refrigerator for a Long Time)

When the Door Alarm Sounds and the Interior Light of the Refrigerator Compartment Blinks (Door Alarm)

The door alarm (with alarm sound, interior light, and compartment display) is activated when a door is open for 1 minute or longer.

The pattern of the door alarm sound and the action of the interior light and compartment display area are as follows depending on how long the door has been left open.

Time for which the door left open	1 minute	2 minutes	3 minutes	4 minutes	5 minutes or longer	60 minutes or longer
Alarm sound	4 short beeps, then 2 beeps	4 short beeps, then 3 long beeps	4 short beeps, then 4 long beeps	After 4 short beeps, Continuous long beeps	Continuous short beeps	
Interior light	On			Blinks twice per minute		Off
Compartment display area	The compartment display area will blink in synchronization with the alarm sound					

- Check that the doors are not left ajar or do not have any food trapped (the packing, the back of the drawer cases). (Check at least once a month.)
- All doors have an opening and closing sensor.
- Check the refrigerator compartment door rotating partition. ➔ **Page 10**



Compartment display area
(Operation panel)

Blinks in synchronization with the alarm sound.

Example: When the doors of the ice making compartment and freezer compartment are open

When the Alarm Cannot be Turned Off

Check that there are no gaps between the door.

When the alarm cannot be turned off, there may be a malfunction and an inspection is required. Contact the retail store where you purchased the refrigerator.

To Stop the Alarm (Continuous Short Beeps)

The alarm can be temporarily stopped in the time before the refrigerator is repaired.

Press  for at least 5 seconds.

* If performing the above operation does not turn off the alarm, or the alarm periodically sounds, check peripheral machinery as well.

When the Mark Blinks Rapidly (About 5 Times per Second)

When the refrigerator will not cool, there may be a malfunction and an inspection is required.

Contact the retail store where you purchased the refrigerator.

When Not Using the Refrigerator for a Long Time (When the Power Plug Is Unplugged)

① Set to the "STOP" ice making mode. ➔ **Pages 21 - 22**

- Check that  is lit.

② Remove the power plug.

③ Empty any water or ice from the water tank, ice tray, and ice storage box and clean.

Wash the water tank, water supply pump, tank pipe, tank cap, lid, water supply pipe, ice storage box, soundproof mat, ice tray and ice server, dry them completely, and then return them to their original positions.

➔ **Pages 26 - 27**

- Do not dispose of the soundproof mat.

④ Clean the interior of the refrigerator and open the doors for 2 to 3 days to dry the inside.

* If the refrigerator is not dried sufficiently, it may cause mold, odors, or refrigerant (gas) leaks due to condenser corrosion.

Notice

- Wash the water tank, water supply pipe, and ice tray before making ice for the first time, or if you have not made ice for more than a week. Odors or dust may be adhering to the parts.

Other Issues (To Move or Transport the Refrigerator)

To Transport the Refrigerator

- 1 Empty any water or ice from the water tank, ice tray, and ice storage box. → **Pages 26 - 27**
- 2 Wear protective gear (gloves).
- 3 Remove the adjustable support cover, and then rotate and raise the adjustable supports. → **Page 7**
- 4 Remove the power plug.

- 5 Lay towels under the drainage port and the lower rear edge of the refrigerator, and position a container or tray with a height of about 3 cm on the towels to collect the water.

* The towels prevent floor damage, and water from being spilled on the floor.

- 6 Tilt the refrigerator slowly to the rear by about 30 degrees, and drain the water from the evaporation tray via the drainage port on the lower rear side. (The evaporation tray is not visible from the outside.)

* Because the refrigerator is heavy, the work must be performed by at least 4 people.

* The work must not be performed by small children or people who are not capable of doing heavy work. Ask a specialist transportation company.

- 7 4 or more people should hold the hand-holds on the bottom and the upper part of the rear side and the hand-holds on the lower inside part of the front side and the upper side of the rear, and carry the refrigerator slowly.

- Do not lay down the refrigerator on its side. (The compressor may be damaged.)

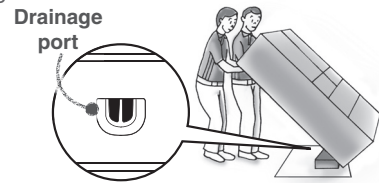

Bottom handles

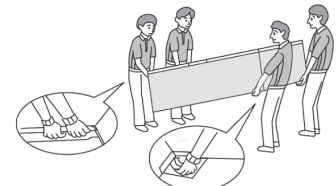

Front lower inside

Hand-holds on the rear upper side

When the Transportation Time Is Long, for Example When Moving House

- Frost from the condenser inside the freezer compartment will melt, and may spill water when the refrigerator is transported. It may take 1 day to defrost after unplugging the power plug.



Prohibited

Do not damage the refrigerator's refrigerant circuit (pipes).

Because combustible refrigerant is used, this may result in fire or an explosion.

Trouble-shooting

To Move the Refrigerator in Forward and Backward Directions

- 1 Remove the adjustable support cover, and then rotate and raise the adjustable supports. → **Page 7**
- 2 Lay protective material under the casters and rear supports to prevent damaging the floor.
- 3 Move the refrigerator in the forward and backward directions.

* Moving in any direction other than forward and backward may damage the floor. Please make sure to lay protective material such as a plate or board on the floor.

Other Issues (Condensation Prevention Heater Setting, Temperature Fine Adjustment Mode)

To Control the Temperature More Precisely (Temperature Fine Adjustment Mode)

The temperature can be set to 19 different levels for the refrigerator compartment and freezer compartment, while it can be set to 24 different levels for the versa compartment (5 levels when set to Soft-Freezing and 19 different levels for Freezing).

- When temperature fine adjustment mode is set, the compartment display blinks about every 10 seconds.

Setting the Temperature Fine Adjustment Mode

- 1 Touch to light up icons.
- 2 Touch and select the compartment you would like to set to temperature fine adjustment mode.
- 3 Touch for at least 5 seconds (until the buzzer sounds).
 - The refrigerator compartment, freezer compartment, and versa compartment can all be set with a single operation.

To Cancel

The same operation as above.

- If the setting is reset, it will be cancelled.

Performing the Temperature Fine Adjustment

- 1 Touch to light up icons.
- 2 Touch to select the compartment to perform temperature fine adjustment.
- 3 Repeatedly touch to perform temperature fine adjustment.

Display Example: When the refrigerator compartment is set to Temperature Setting 5.

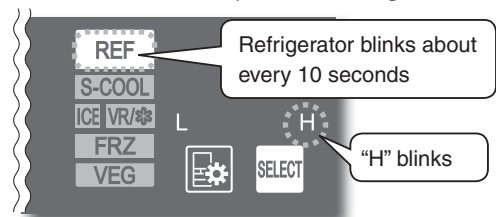

Refrigerator Compartment / Freezer Compartment / Versa Compartment (Freezer Setting)

	Temperature setting
1	L
2	L
3	L
4	L
5	L
6	L
7	L

8	L
9	L
10	M
11	L
12	
13	
14	
15	L

16	
17	M
18	
19	

Versa Compartment (Soft-Freezing Setting)

	Temperature setting
1	L
2	L
3	M
4	
5	H

* represents a blinking display.

* The versa compartment can be consecutively set to the Soft-Freezing setting and the Freezing Setting.

Troubleshooting

Before contacting MITSUBISHI ELECTRIC SERVICE CENTRE or its service agent or making a repair request, check the following.

If the problem persists, contact the retail store where you purchased the refrigerator as soon as possible.

Frequently asked questions in the initial period and in summer

The refrigerator does not cool at all!

- The refrigerator takes time to cool when you first start using it. In summer, it may take up to 24 hours for the inside to be fully cooled. → **Page 7**
- If **D** is shown on the operation panel, cancel demonstration mode. → **Page 31**
- Check if the power plug is disconnected or the circuit breaker has tripped.

The outer walls heat up!

- The outer walls heat up significantly (to about 50 to 60°C) immediately after installation and in summer. This is because the heat discharging and condensation prevention pipes are located on the sides and the top of the refrigerator. They are required for cooling and the heat is not an abnormality.
- The refrigerator compartment rotating partition also has a condensation prevention heater that heats up.
- A heat discharging fan is located under the refrigerator. Warm air may be discharged from here.

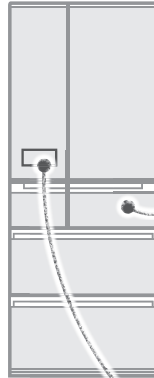
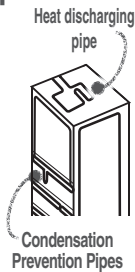

In Versa Compartment...

Ice cream melts

- For storing ice cream and frozen foods, set to "FRZ" "H". → **Pages 21 - 22**

Soft-Freezing is set at the time of purchase.

Food does not quickly freeze

- With Soft-Freezing, food freezes at about -7°C, so it may take up to about 24 hours for food to completely freeze.
- Supercool freezing takes time (about 8 to 9 hours) to uniformly freeze food from the core.

Soft-Freezing freezes food

- Food appears to freeze just as when it freezes in the freezer.



The operation panel turns off automatically!

- If 30 seconds pass without any operation panel button operations, the display turns off. When lighting, touch . → **Page 8**

	Problem	Check	Explanation and Action
Cooling Performance	Does not cool well Not much ice is made Ice melts	① Has enough time passed after installation?	It takes 4 to 5 hours for the refrigerator to cool, and may take 24 hours in summer to fully cool.
		② Is the temperature setting set to "L"? Is the compartment set to Power Save Mode?	Set to "M" or "H", or set the versa compartment to "FRZ·H" or to the setting of your liking. → Pages 21 - 22 Cancel Power Save Mode. → Page 24
		③ Is the flow of cold air being blocked? Are the doors being opened frequently, or left ajar? Is food blocking them?	Make space between foods and remove any food that is sticking out of shelves or touching the ceiling of the drawers. Avoid opening and shutting the door for a while.
		④ Is heat discharging being blocked? Check if there is no gap around the refrigerator and the refrigerator is exposed to direct sunlight.	Check that there is enough space around the refrigerator and that it is properly installed. → Page 6
	Food freezes in the refrigerator and vegetable compartments	① Is the temperature on the operation panel set to "H"?	Set the temperature to "M". Also, the temperature with each setting may temporarily decrease.
		② Is food with a lot of moisture stored at the rear of the shelf?	Place drinks and food containing a lot of water, such as tofu, vegetables and fruits, at the front of the shelf or in a door pocket.
		③ Is the surrounding temperature 5°C or less?	Food in the refrigerator compartment or vegetable compartment may freeze. Freezing is less likely when the temperature settings are set to "L". → Pages 21 - 22
		④ Is the water supply pipe installed correctly without any gaps or looseness?	If there are foreign objects loosening the pipe or if there is a gap, strong cold air can flow into the refrigerator compartment. Make sure that it is securely set. → Page 27
Supercool chilling	Food in the lower case freezes	① Is the surrounding temperature 5°C or less?	Set the temperature of the lower case (when Supercool chilling is set) to "L". → Page 21
		② Is the refrigerator compartment's temperature set to "H"?	Set the temperature of the refrigerator compartment to "M" or "L", or set the temperature of the lower case (when Supercool chilling is set) to "L". → Page 21
		③ Have you placed easily frozen food containing a considerable amount of moisture in the compartment?	Place food containing a lot of water at the front of the refrigerator compartment or in a door pocket.
		④ Are you piling frozen food onto other food?	Food that touches frozen food may freeze.



Trouble-shooting

Troubleshooting (Continued)

	Problem	Check	Explanation and Action
Versa Compartment	Food in the versa compartment melts	① When storing ice cream and frozen foods, did you set the refrigerator to “FRZ•H”?	“SOFT FRZ”, “FRZ•L”, and “FRZ•M” are higher temperature settings. Set to “FRZ•H”. ➔ Pages 21 - 22
		② Did you set Hot freezing after placing hot food inside? 	When placing hot food in the compartment, use Hot freezing. ➔ Page 15 
		③ Is the versa compartment set to Power Save Mode?	Cancel Power Save Mode. ➔ Page 24
		④ When placing hot food in the compartment, did you place it away from other food?	Frozen food may thaw if it makes contact with hot food. Leave space.
		⑤ Is food piled up in the upper area?	Leave a gap so that cold air can flow to the ceiling and between food.
		⑥ Has enough time passed after installation?	The refrigerator takes time to cool completely.
Versa Compartment	Soft-Freezing freezes food too hard	① Is the versa compartment set to “FRZ”?	Set the versa compartment to “SOFT FRZ”. ➔ Pages 21 - 22
		② Does the food contain a lot of moisture?	Foods containing a considerable amount of moisture may freeze too hard. We recommend leaving the food for about 5 to 15 minutes, placing the other hand on the back of a knife, and cutting the food by pushing on it. Also, use the setting “SOFT FRZ•L”.
		③ Is food freezing the same way as with “Freezing”?	Food appears to freeze in the same way as with “Freezing”.
Automatic Ice Making	Cannot make ice Water in the tank stays at the same level	① Has enough time passed after installation?	It takes 4 to 5 hours for the refrigerator to cool, and 24 hours or more in summer to make ice.
		② Has food, the ice server, or another object been left in the ice storage box?	Remove food or other objects from the ice storage box. The ice storage box is judged to be full of ice. Also, spread the ice out flat all the way to the front.
		③ Is the ice making setting for the ice making compartment set to “ICE STOP”?	Set the ice making compartment's setting to ICE . ➔ Pages 21 - 22
		④ Are the ice tray and ice tray lock lever installed correctly?	Set the ice tray lock lever to the correct position and check the installation status of the ice tray. ➔ Page 27
		⑤ Is the water supply pipe installed correctly in the tank holder area?	Remove any foreign objects creating gaps and install the pipe so that it is not loose. ➔ Page 27
		⑥ Are the water supply pump and tank pipe installed correctly onto the water tank?	Check that they are correctly installed. In particular, ensure that the opening of the tank pipe inside the tank is installed firmly to the tank. ➔ Pages 26 - 27
		⑦ Is the ice making compartment set to Power Save Mode?	Cancel Power Save Mode. ➔ Page 24
Automatic Ice Making	Water tank or water supply pipe freezes	① Are the water supply pipe and water tank installed to the refrigerator without any gaps? Additionally, is the tank pipe installed to the water tank without any internal gaps?	Check the installation around the water tank. If there are gaps, the cold air may escape and water may freeze. ➔ Pages 26 - 27
Automatic Ice Making	Ice is small or joined together	① Has ice been stored inside the ice storage box for a long time?	Ice stored inside the ice storage box for a long time may shrink or join together (due to a phenomenon called sublimation). When not using ice, it is recommended that you remove the water and stop the ice making.
		② Is the ice making compartment set to Power Save Mode?	Cancel Power Save Mode. ➔ Page 24

	Problem	Check	Explanation and Action
Sound	There is a rattling sound	① Are any nearby objects in contact with the refrigerator?	Leave space around the refrigerator. When objects or walls are in contact with the refrigerator, sounds may be heard.
		② Make sure that the water tank and water supply pipe are properly installed.	Push in the water tank until it touches the rear side. If it is out of position, the sound of the water supply pipe can grow loud. If there are any gaps or looseness, the water may freeze, causing sounds to be heard.
	Loud noises Worrisome noises (Noises described on the right are normal)	① The noise gets louder suddenly or the tone changes.	Immediately after beginning use, when the weather is hot, when the doors are frequently opened and closed, and in similar situations, the refrigerator switches to high-speed operation and cools with high power.
		② A whistling sound is made after closing a door.	This is the sound of the cooling fan motor starting.
		③ A whipping or dripping sound is sometimes heard from inside the refrigerator after a door is opened.	This is the creaking sound as warm air enters and expands the plastic.
		④ Sometimes the sound of flowing or boiling water can be heard.	This is the sound of the refrigerant (gas) flowing.
⑤ A rattling or squeaking sound is made sometimes (every 1 to 2 hours).	This is the sound of the automatic ice maker. Even when there is no water in the water tank, the automatic ice maker and pump make a sound about every 100 minutes.		
⑥ After turning on the power, a thumping or creaking sound may be heard in the ice making "ICE STOP" mode (every 1 to 2 hours).	This is the sound of the operation check. The check is performed even in the "ICE STOP" ice making mode.		
Door	Doors do not close Doors open easily	① Is a door making contact with food or a case? Is too much food packed inside?	Store food so that the door does not make contact with the food when closed. In the refrigerator compartment, store food on the shelves and in the drawer doors store food so that it does not make contact with the ceiling when doors are shut and opened.
		② Has food fallen behind a case in a drawer door, or is the power cord or another object trapped between the refrigerator and a door?	Remove any objects. Make sure that the door does not trap objects such as food, power cords or plastic bags.
		③ Is the refrigerator installed stably? Are the adjustable supports making contact with the floor?	Lower the adjustable supports to raise the front side slightly and make the doors easier to close. ➔ Page 7
	The alarm will sound	① Check if the doors are closed.	Refer to "When the door alarm sounds" and "When the alarm cannot be turned off". ➔ Page 32
Operation Panel	The operation panel does not respond	① Is  lit?	Cancel the Child Safety Lock. ➔ Page 31
		② Are the user's fingers or the operation panel wet or dirty?	Wipe off the moisture and dirt on the operation panel and fingers.
		③ Are you wearing gloves on your hands or sticking plaster on your fingers during operation? Are you operating with your fingernails?	Touch the operation panel with your finger directly.
		④ Are you repeatedly touching it?	Let your finger off the operation panel once and then touch it again. It will respond when you let your finger off.
		⑤ Are seals and tapes put on the operation panel?	Remove the seals and tapes.
	Reacts without a touch	① Are there any towels, plastic bags, papers, etc. over the operation panel?	Remove the towel, plastic bag, paper, etc.
	Some icons do not light up	① Is it set to Power Save Mode?	The icons that cannot be set during Power Save Mode are off. ➔ Page 25
	ICE is blinking and won't go off	① Is the ice tray lock lever not locked?	If you release the ice tray lock lever while the ice tray is operating, ICE will blink. Lock the ice tray lock lever and close the ice making compartment's door.
Condensation/ Frost	Condensation forms on the outer walls and inside the refrigerator Frost forms in the freezer compartment Water drips onto the floor	① Are the doors being opened frequently, or are there any gaps?	Close the doors so that there are no gaps. When moisture in the air cools, it forms frost or condensation. When there is high humidity, condensation or frost will form even in very small gaps. Regarding the Vegetable Compartment ➔ Page 19
		② Is the humidity high, for example is it raining?	Condensation may form temporarily. Wipe off with a dry cloth. Condensation may cause frost to form in the freezer compartment. Please minimize the time when doors are kept open.

Troubleshooting (Continued)

	Problem 	Check 	Explanation and Action
Others	There are lines like scratches on the clear parts	① Is it a thin line without level difference on its both sides?	This is a mark created at the time the plastic is molded. It is created at the joint where resin flows. This is not a flaw.
	There are holes in the door and the refrigerator walls	① Are there small holes in the door or in the refrigerator walls?	These are holes that let air escape for the injection of foam heat insulating materials in the manufacturing process. These are not flaws or abnormalities.
	The surface of the sides or doors is warped	① Does the light reflected on the surface appear distorted?	Warping and surface waviness occurs in the manufacturing process. When light hits the surface, it may appear warped, but this is not an abnormality.
	Noise interferes with televisions or other devices	① Is the refrigerator installed near an electronic device such as a television?	Install the refrigerator away from electronic devices such as televisions.
		② Is the power to the refrigerator supplied from a socket near the entry hole of the antenna cable?	Use separate power. When using a 2 pin plug, use grounding.
There is a bothersome smell (Food / Ice)	① Have you placed food with strong odor inside the refrigerator without sealing it in a container?	Store food with strong odor in packaging. The odor may not be removed with a deodorizing apparatus.	
	② Do you periodically clean the water tank?	Clean periodically. ➔ Pages 26 - 27	

Specifications

■ This appliance is designed for use in Australia and New Zealand only and cannot be used in any other country. No servicing is available outside of Australia and New Zealand.

	Food storage compartment type	Gross volume (litres)	Storage volume (litres)
Refrigerator compartment	Special (unfrozen food)	377	337
Ice making compartment	Short term frozen food	25	4
Versa compartment	Short term frozen food	56	28
Freezer compartment	Freezer	151	81
Vegetable compartment	Cellar	134	93
	Total volume	743	543

	Parts	Quantity
Refrigerator compartment	Glass Shelf (Upper)	1
	Glass Shelf (Middle)	1
	Glass Shelf (Lower)	1
	Partition	1
	Slide Glass Shelf (Front)	1
	Slide Glass Shelf (Back)	1
	Upper Case Cover	1
	Upper Case	1
	Lower Case	1
	Water tank (with leadcleaning filter)	1
	Adjustable Pocket (Large)	2
	Adjustable Pocket (Small)	2
	Egg Tray	1
	Egg Shelf	1
Bottle Pocket (Large)	1	
Bottle Pocket (Small)	1	
Ice making compartment	Ice Tray	1
	Ice Storage Box	1
	Soundproof Mat	1
	Ice Server	1
versa compartment	Versa compartment case	1
	Aluminum Tray	1
Vegetable compartment	Vegetable Case (Upper)	1
	Vegetable Case (Lower)	1
Freezer compartment	Freezer Case (Upper)	1
	Freezer Case (Lower)	1
	Adjustable support cover	1

Trouble-shooting

- This refrigerator uses flammable foaming gas for insulation.
Please deliver the unit to specialized industrial waste dealer when you do away it.
Please follow the rules in your country.
- **WARNING** - Do not use mechanical devices or other means to accelerate the defrosting process, other than those recommended by the manufacturer.
- **WARNING** - Do not use electrical appliances inside the food storage compartments of the appliance, unless they are of the type recommended by the manufacturer.
- **WARNING** - Just in case of having damaged the refrigerant circuit, do not use electric items or fire equipments near by, and open the window to ventilate the room. And contact the retail store at which you purchased it or the following MITSUBISHI ELECTRIC SERVICE CENTRE.
- The refrigerator contains flammable refrigerant (R600a: isobutane).
- The refrigeration system behind and inside the refrigerator contains refrigerant.
Do not allow any sharp objects to come into contact with the refrigeration system.
- Do not block the openings on the circumstances of the refrigerator.
- The user manual should be handed over to any person who would use or handle the refrigerator whenever the refrigerator would be transferred to another location and delivered to a recycling plant.
- The appliance is not intended for use by young children or infirm persons without supervision.
- Young children should be supervised to ensure that they do not play with the appliance.

R600a Refrigerant Warning

- This appliance contains a small quantity of R600a refrigerant which is flammable.
- During transportation and installation, ensure that the tubing of the refrigerant circuit is not damaged.
- Leaking refrigerant can ignite and may damage the eyes.
- In the event any damage does occur, avoid exposure to open fires and any device which creates a spark.
Disconnect the appliance from the mains power.
- Thoroughly ventilate the room in which the appliance is located for several minutes.
- Notify Mitsubishi Electric Australia Pty Ltd. for necessary action and advice.
- The room for installing the appliance must be at least 1 cubic metre per 8 grams of refrigerant.
The refrigerant quantity contained in this appliance is noted on the Rating Label of the appliance.
- If your Mitsubishi Electric Refrigerator should require service, please contact Mitsubishi Electric Australia Pty Ltd see back page of this user manual for contact details.

NOTE: MITSUBISHI ELECTRIC AUSTRALIA PTY LTD. DO NOT ALLOW SERVICE TO THE REFRIGERATION CIRCUIT OF THIS APPLIANCE.



If an abnormality or malfunction occurs, stop operation immediately and contact the retail store where you purchased the refrigerator or a MITSUBISHI ELECTRIC SERVICE CENTRE or its service agent.

SOLE AGENT in Australia

MITSUBISHI ELECTRIC AUSTRALIA PTY LTD.

(Incorporated in New South Wales) ABN 58 001 215 792

New South Wales:

348 Victoria Road, Rydalmere NSW 2116 Ph: (02) 9684 7777, Fax: (02) 9898 0484

Queensland:

Da Vinci Business Park, Building 101, 2A Boronia Road, Brisbane Airport QLD 4008

Ph: (07) 3623 2000, Fax: (07) 3860 6761

South Australia / Northern Territory:

Suite 1, 224 Glen Osmond Road, FULLARTON SA 5063 Ph: (08) 8338 1001, Fax: (08) 8338 0501

Western Australia:

Unit 5, 329 Collier Road, Bassendean WA 6054 Ph: (08) 9377 3400, Fax: (08) 9377 3499

Victoria / Tasmania:

Suite 2, 10 Compark Circuit, Mulgrave VIC 3170 Ph: (03) 9535 7800, Fax: (03) 9535 7801

SOLE AGENT in New Zealand

BLACK DIAMOND TECHNOLOGIES LIMITED (BDT)

Wellington Office (Head Office)

1 Parliament Street, Lower Hutt, PO Box 30772, Lower Hutt 5040 Ph: (04) 560 9147, Fax: (04) 560 9133

Auckland Office

Unit 1, 4 Walls Road, Penrose, PO Box 12726, Penrose, Auckland 1061 Ph: (09) 526 9347, Fax: (09) 526 9348

Christchurch Office

44 Halwyn Drive, Hornby, PO Box 16904, Hornby, Christchurch 8441 Ph: (03) 341 2837, Fax: (03) 341 2838

MITSUBISHI ELECTRIC CORPORATION