



Refrigerator-Freezer

MODEL

**MR-EX655W-N-A (230-240V)**

**MR-EX562W-N-A (230-240V)**

---

## OPERATING INSTRUCTIONS



**R600a**

# Function Overview

Complicated controls  
become easy with a touch panel!

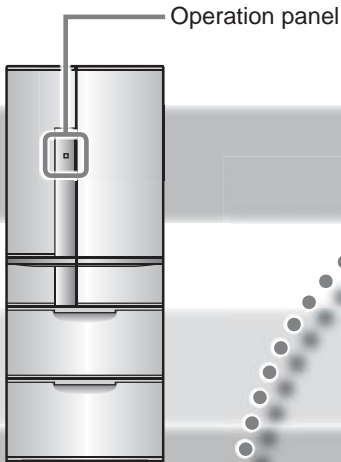

If you touch the operation panel, icon will be displayed. You can select the setting that you prefer.



Want to Rapid cool bulk shopping



Want to Keep vegetables moist



Want to Cool drinks quickly



Power Saving



Want to make ice quickly



Want to stop making ice



Want to store food with Soft-Freezing



Freeze to savory taste (Supercool Freezing)



Check the power-saving condition

# Contents

	Page
Safety Precautions	4-5
From Installation to Operation	6-7
Placing Food Inside	8-9
Refrigerator Compartment	10
Versa, Freezer, and Vegetable Compartments	11
Ice Making Compartment (Automatic Ice Maker)	12-13
How to Use the Operation Panel	14
Rapid Cool Bulk Shopping, Keep Vegetables Moist, Cool Drinks Quickly	15
Power Saving	16
Changing the Setting of the Ice Making Compartment	17
Changing the Setting of the Versa Compartment	18-19
Tips for Supercool Freezing Soft-Freezing	20-21
Setting the Details <small>(The temperature setting change) (Power Save Mode)</small>	22-25
Cleaning the Automatic Ice Maker	26-27
Removing and Cleaning the Parts	28-29
Other Issues	30-33
Specifications	34
Troubleshooting	35-37

Before Use

Placing Food Inside

Operation

Cleaning

Troubleshooting

▶ Page 14

▶ Page 15

▶ Page 16

▶ Page 17

▶ Page 18

▶ Page 19

▶ Page 16

- This refrigerator is manufactured for refrigerating and freezing foods in general households. For industrial use, please use a commercial refrigerator.
- The material names are indicated on the main plastic parts to facilitate recycling.
- Illustrations for MR-EX655W are used in explanations.

# Safety Precautions

Before Use

The danger and degree of danger caused by improper handling are categorized and described with the following indicators.

## Warning

Improper handling that can result in death or serious injury.

## Caution

Improper handling that can result in personal injury or damage to your house, household furnishings, etc.

■ Meaning of symbols.



Never do



Never touch



Never attempt to disassemble, repair or alter



Never expose to water



Never touch with wet hands



Be sure to follow the instructions



Be sure to remove the power plug from the socket



If an abnormality or malfunction occurs, stop operation immediately and contact the retail store where you purchased the refrigerator or a Mitsubishi Electric Maintenance Service or Customer Service representative.

Placing Food Inside

Operation

Cleaning

Troubleshooting

## Installation

### Leave space around the refrigerator.

If refrigerant leaks, it may accumulate and catch fire or explode.

▶ Page 6



Leave space

### Anchor the refrigerator to a strong wall or post to protect against damage during earthquakes.

The refrigerator may tip over and cause injury.

▶ Page 7



Prevent tipping

### Do not install the refrigerator outdoors or in places exposed to water or excessive humidity.

Water may cause insulation failure, resulting in an electric shock or fire.

▶ Page 6



Water prohibited

### Use a dedicated outlet for the power supply that meets the rating specified on the rating label. (The rating label is located on the door-liner of the refrigerator compartment.)

Using extension cords and plugging too many leads into a single socket can cause heat build-up or fire.

▶ Page 6



Only use an outlet that meets the specified rating.

### If the power cord is damaged, call our MITSUBISHI ELECTRIC SERVICE CENTRE for the replacement.

If the power cord is damaged, purchase a new cord from MITSUBISHI ELECTRIC SERVICE CENTRE. Make sure that the power cord is designed for this model. Power cords should only be replaced by a qualified person.

▶ Page 6



Service Call

### Insert the power plug with the cord facing down, and fully insert the prongs

Inserting the plug upside-down places stress on the cord and may cause heat generation or fire.



Cord facing down

## Power and power plug

### Remove the power plug before cleaning.

Otherwise an electric shock or injury may result.



Remove plug

### Do not crush the power plug with the rear of the refrigerator.

Do not damage the power cord.

Pressing, folding, bundling or placing heavy objects on the power cord may cause an electric shock or fire.



Prohibited

### Do not use damaged cords or plugs, or loose sockets.

Doing so may cause an electric shock or fire.



Do not use

### Do not pull the cord when unplugging the power plug.

The cord may be damaged, resulting in an electric shock or fire.



Prohibited

### Remove dust periodically from the power plug.

Dust may cause insulation failure, resulting in fire.



Remove dust

### Do not plug in or out the power plug with wet hands.

Doing so may cause an electric shock.



Wet hands prohibited

## Installation and transportation

Anchor the refrigerator to a strong and level floor by adjusting the adjustable supports.

Otherwise, the refrigerator may move and cause injury.

▶ Pages 6 - 7

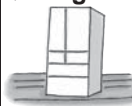

Install level

Use the transportation hand-holds when transporting the refrigerator.

Holding other parts may result in injury.

▶ Page 31



Use the hand-holds

Be careful not to damage the floor or injure yourself when moving the refrigerator.

Lay a protective sheet on the floor and move the refrigerator slowly.



Use protective material

























Do not pack in excessive amounts of food.











Do not pull the shelves with excessive force. Food may fall and cause an injury













Prohibited

# Warning

Operation		
<p><b>Do not place water containers on top of the refrigerator.</b> Exposing electrical parts to water may cause an electric shock or fire.</p>   <p>Water prohibited</p>	<p><b>Do not use electrical appliances inside the refrigerator.</b> The refrigerant gas leaking into the compartment with sparks from an electrical contact may cause fire and explosion.</p>   <p>Prohibited</p>	<p><b>Do not place volatile, inflammable objects inside the refrigerator.</b> Benzene, cosmetics and hair dressing products may catch fire or explode.</p>   <p>Do not store</p>
<p><b>Do not place objects on top of the refrigerator.</b> Objects may fall when the doors are opened or closed and cause injury.</p>   <p>Prohibited</p>	<p><b>Do not store chemicals or scientific specimens in the refrigerator.</b> Substances that require strict control must not be stored in household refrigerators.</p>   <p>Do not store</p>	<p><b>Do not hang from the door or handle. Do not climb on an open door. Do not apply a heavy load.</b> The refrigerator may tip over and cause injury.</p>   <p>Prohibited</p>
<p><b>Do not touch the mechanical area of the automatic ice maker (area above the ice tray).</b> Doing so may result in injury.</p>   <p>Do not touch</p>	<p><b>Do not damage or drive screws into the refrigerator's refrigerant circuit (pipes).</b> Because combustible refrigerant is used, this may result in fire or an explosion.</p>   <p>Prohibited</p>	<p><b>If you notice a gas leak, do not touch the refrigerator. Open windows to ventilate.</b> Sparks from an electrical contact may cause an explosion or fire.</p>   <p>Ventilate</p>
<p><b>Do not wash with water or spill soup or juice onto the refrigerator.</b> Water or other liquid may cause an electric shock or fire. Wipe off any liquid immediately.</p>   <p>Water prohibited</p>	<p><b>Do not use combustible sprays near the refrigerator.</b> Sparks from an electrical contact may cause an ignition and fire.</p>   <p>Do not use</p>	<p><b>Do not use in a shed or garage.</b> Small animals may damage the electrical wiring and cause an electric shock or fire.</p>  <p>Do not use</p>
<p><b>When the doors are opened or closed, beware not to hit any furniture</b> The door or furniture may be damaged and cause any injury.</p>  <p>Prohibited</p>		

Malfunctions and long-term storage	When Recycling
<p><b>If the refrigerant circuit (pipe) is damaged, do not touch the refrigerator and avoid using flames. Open windows to ventilate.</b> If the refrigerant circuit is damaged, contact the retail store.</p>   <p>Ventilate</p>	<p><b>For storage, make sure to pull out and remove the door seal.</b> There is a possibility of a child getting trapped in the refrigerator during storage.</p>   <p>Remove door seal</p>
<p><b>Do not disassemble, repair or alter. Do not use while parts are damaged.</b> Doing so may cause injury, electric shock or fire.</p>   <p>Do not disassemble</p>	<p><b>When not using the refrigerator for a long time, unplug the power plug and open the doors to dry the refrigerator.</b> If the refrigerator is not dried sufficiently, refrigerant may leak due to condenser corrosion and cause a fire or explosion.</p>   <p>Remove plug</p>  <p>Dry</p>
	<p><b>Contact the retail store or municipal government for details about correct refrigerator disposal.</b> Improper disposal may cause refrigerant leaks, resulting in a fire or explosion if exposed to a flame.</p>  <p>Dispose properly</p>

# Caution

Operation				
<p><b>Do not touch food or containers in the freezer compartment with wet hands.</b> It may cause a cold injury.</p>   <p>Wet hands prohibited</p>	<p><b>Do not place glass bottles in the freezer, ice making and versa compartments.</b> The bottle may break if the liquid inside freezes, causing an injury.</p>   <p>Do not store</p>	<p><b>Do not put your hands or feet under the refrigerator.</b> The steel plates or other parts may cause injury.</p>   <p>Do not touch</p>	<p><b>Do not eat food that is discolored or has a bad odour.</b> It may result in food poisoning or illness.</p>   <p>Prohibited</p>	<p><b>Observe the following when opening and closing the doors.</b></p> <ul style="list-style-type: none"> <li>• Do not open or close the doors when another person is touching the refrigerator.</li> <li>• Do not put your fingers on the top edge of a drawer-type door while closing it.</li> <li>• Do not open or close the doors with excessive force. (Food may fall out and cause injury.)</li> <li>• Be careful not to trap your fingers or any other part of your body.</li> <li>• Be careful not hit a part of your body.</li> <li>• Do not trap your feet with the bottom drawer. (Danger of your toes caught by the drawer.)</li> </ul>   <p>Prohibited</p>

Before Use

Placing Food Inside

Operation

Cleaning

Troubleshooting

# From Installation to Operation

Before Use

Placing Food Inside

Operation

Cleaning

Troubleshooting

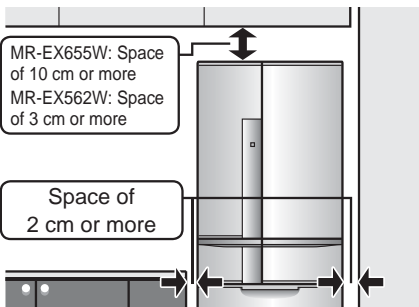

Dedicated outlet that meets the specified rating.

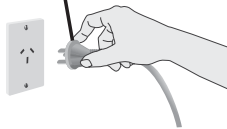

Turn on the power of the refrigerator as soon as possible.  
The refrigerator will not be damaged even if you turn on the power immediately after the installation.

## 1 Installation

Install the refrigerator at:

- **A place with good ventilation and not exposed to direct sunlight or hot air**  
To keep good cooling performance and reduce power costs.

- **A place with low humidity**  
To prevent it from rusting, electric shock and fire.

- **A strong and level place**  
To prevent vibration, noise, and ajar or tilting doors.  
To prevent deformation or discoloration of the floor materials due to the weight or heat.

(If the refrigerator supports may sink into the floor, lay a strong plate or board underneath.)

- **A place away from other devices**  
To prevent noise or video interference with devices such as televisions.

- **There should be space of 2 cm or more on the left and right of the refrigerator, and 10 cm or more (MR-EX655W), or 3 cm or more (MR-EX562W) from the ceiling.**  
To allow heat to dissipate from the top and the sides of the refrigerator.

**Use in hot spring areas**

Corrosion control treatment may be required for the refrigerant circuit (pipe) due to generation of corrosive gases. Contact the retail store where you purchased the refrigerator.

**Warning**

**Do not obstruct the refrigerator vents or the space around the refrigerator. If refrigerant leaks, it may accumulate and catch fire or explode.**

## 2 Connect the power supply

\*Connect power supply soon after installing the refrigerator

### ● Use a dedicated outlet

Use a dedicated outlet for the power supply that meets the rating specified on the rating label. (The rating label is located on the door-liner of the refrigerator compartment.)

**Warning**

**Using outlets that do not meet the specified rating or plugging in too many leads into a single socket can cause heat buildup or fire.**

- **The refrigerator will not be damaged even if the power is supplied soon after installation. It takes a while for the refrigerator to cool, therefore supply power as soon as possible.**

### ● Electrical Connections

**Make sure this unit is properly grounded.**

- The refrigerator should always be plugged into its dedicated electrical outlet.

This will provide the best performance and prevent electrical circuits from being overloaded and causing a fire.

Make sure that the electrical outlet provides the proper voltage. Extension cords are not recommended.

- If your refrigerator is installed in the high humidity location, not only ground connection but also installation of the earth leakage breaker is recommended.

- If the power cord is damaged, purchase a new cord from MITSUBISHI ELECTRIC SERVICE CENTRE. Make sure that the power cord is designed for this model, in order to avoid a hazard.

- Power cords should only be replaced by a qualified person.

**The outside of the refrigerator and the rotating partition get hot.**

- Heat dissipation causes the temperature to rise to about 50 to 60°C or even higher when operation is first started, and during the summer.

- The rotating partition may get hot when heated by the heater.



Rotating partition

**It takes time for cooling even after turning on the refrigerator.**

- Wait until the refrigerator has been fully cooled before storing non-cooled food or ice cream.
- Do not open the doors more than necessary, and close them as soon as possible.

**When making ice for the first time**

When the weather is hot in summer, it may take more than 24 hours.

### Bottom front of refrigerator

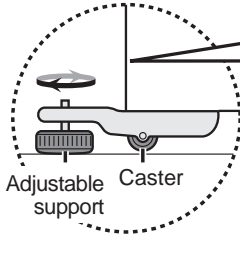
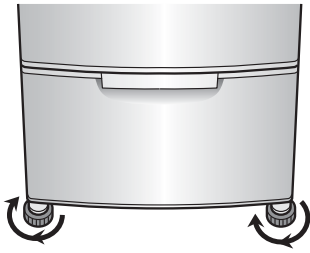

Turn the adjustable supports in the arrow direction until they touch the floor.

**Caution**  
If the supports are not adjusted properly, the refrigerator may move and cause injury.

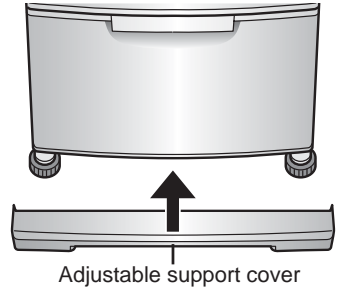

Adjustable support cover

## 3 Adjustment and anchoring

(To prevent vibration, noise, movement, and doors left ajar)  
Turn and lower the adjustable supports until they touch the floor and the front casters are raised from the floor to fix the refrigerator.

- Preventing doors from being left ajar
- Adjusting a tilted door or unevenness

Adjust the supports to make the refrigerator level. If the front of the refrigerator is slightly raised, the doors are easier to close.

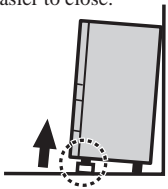

Adjust the adjustable supports as shown in the figures below.

The right door tilts down

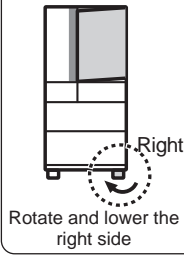

The left door tilts down

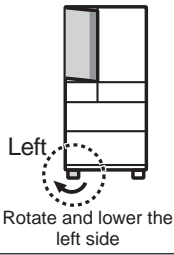

If the installation location is not level or the supports sink after a few days of installation due to the weight of the food, the doors may appear tilted. Readjust the supports.

\* More than 100 kg of food can be stored in the refrigerator.

- If the door is still tilted after adjustment of the supports

When installing the refrigerator in the corner of a room, one of the rear supports may sink, causing the refrigerator to tilt. If this happens, use a caster support or strong board for adjustment. (Normally, use a board with a thickness of 2 to 3 mm.)

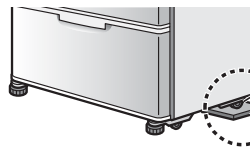

Rear support  
Caster support or strong board

## 4 Adjustable support cover

The adjustable support cover is stored inside the refrigerator compartment at shipment.

- Installing the adjustable support cover

Fully insert the adjustable support cover horizontally until it touches the rear side.

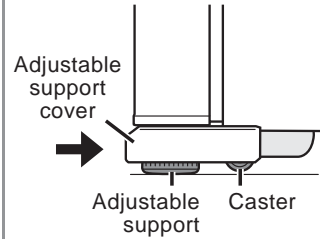

Adjustable support cover  
Adjustable support Caster support

### The operation noise gets louder immediately after installation.

Immediately after installation, when the weather is hot, the doors are frequently opened or closed, or any similar situation; the operation noise will get louder because the refrigerator will switch to high-speed operation to cool with high power.



### Do not damage the refrigerant circuit (pipes) or drive screws into it.

Although flammable refrigerant is used, the refrigerant circuit is hermetically sealed and normally leaks will not occur.

#### Warning

- Should the refrigerant circuit be damaged:
1. Do not use flames or electrical appliances nearby.
  2. Open the windows to fully ventilate the room.

Then, contact the retail store where you purchased the refrigerator.

### Prepare for earthquakes (for areas prone to earthquakes)

Pass 2 strong belts through the hand-holds on the top rear of the refrigerator and anchor them to a strong location, such as wall or post.

#### Warning

The refrigerator may tip over and cause injury.

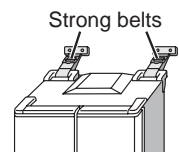

# Placing Food Inside

Before Use

Placing Food Inside

Operation

Cleaning

Troubleshooting

You are now a skillful storage organizer♪  
Get the most out of your refrigerator to make cooking more fun and dishes tastier!

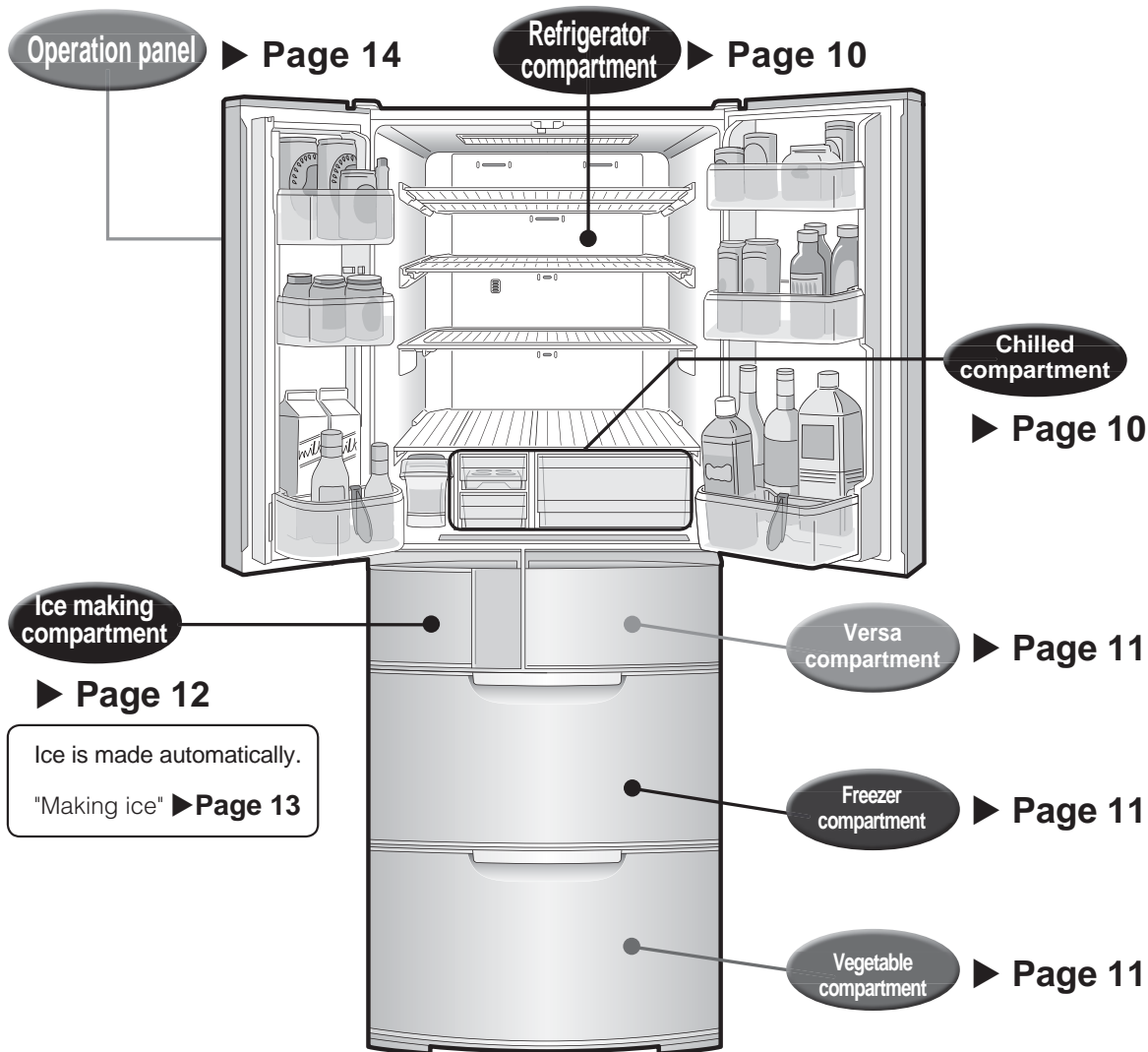

## Approximate temperature setting

Use the refrigerator, freezer, and vegetable compartments set to "M" usually.  
Use the versa compartment in your preferred setting.

- Initial settings (at time of purchase): refrigerator, freezer, and vegetable compartments "M", versa compartment "Soft-Freezing, M"

Note

- The temperatures described here are measured in the lower centre of the refrigerator after the temperature has stabilized when the surrounding temperature is 30°C and the doors are closed without any food inside. The temperature fluctuates with factors such as food storage conditions and how often the doors are opened and closed.
- Plastic may have odours when you first start using the refrigerator. Ventilate the room to prevent odours from being contained, just in case. Odours will gradually disappear.

\*Illustrations for MR-EX655W are used in explanations.

\*The MR-EX562W has only a single two-way flexishelf. ▶ Page 10





**Refrigerator compartment**

About 0°C to 6°C

- Food that are used daily
- Keep eggs in the chilled egg compartment
- Food you do not want to freeze

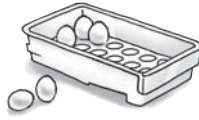

Wrap foods that have strong odour thoroughly before storage

**Food that transfers odours easily**

Rakkyo, dried fish, natto, miso, beef, takuan, sardines, kimchi, jiaozi, etc.

**Food to which odours may easily be transferred**

Puddings, rice, potato salad, tofu, bread, milk, cake, etc.

**Chilled compartment**

About -3°C to 3°C

- Dairy products: Yoghurt, cheese, etc.
- Fish paste products: Steamed fish paste, fish cake, etc.
- Processed food: Ham, sausages, etc.
- Fresh food: Meat, fish, shellfish, etc.



Before Use

Placing Food Inside

**Versa compartment**

Soft-Freezing: About -9°C to -5°C (Can be changed to freezing)

- Cooked rice
- Curry
- Sauces



- Blocks of meat
- Ground meat
- Cutlets, cod roe

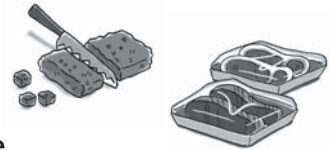

Tips for Supercool Freezing and Soft-Freezing

▶ Pages 20 - 21

Operation

**Freezer compartment**

About -22°C to -16°C

- Frozen food
- Ice cream
- Food frozen at home
- Bread



If you store the food that is Supercool Freezing in the freezer compartment, it can be stored for a long time without losing its taste and texture.

Cleaning

**Vegetable compartment**

About 3°C to 9°C

- Vegetables
- Fruit
- Drinks



The water that evaporates from the food is kept inside the compartment to maintain the moisture. Storing fruit and vegetables in plastic wrap keeps them even fresher.



Troubleshooting

**Caution**

- Do not stack food higher than the case. The food will be caught at the rear of the case and may leave the door ajar.



# Refrigerator Compartment

Before Use

Placing Food Inside

Operation

Cleaning

Troubleshooting

## Refrigerator compartment

### The MR-EX562W has different specifications:

- There is only a single two-way flexishelf.
- The lower (short) adjustable pockets (large and small) are 32 mm smaller.
- The upper adjustable pockets (large and small) are non-adjustable.

### Two-way flexishelf

If you take out the partitions, the shelf will be wide. If you insert the partitions, you can store high objects in the lower shelf.

### Adjustable pocket (small)

Vertically adjustable to 2 positions

### AUTO Shelf

Move the lever to the left or right to adjust the space between the shelves.

### Small item holder

### Bottle pocket (small)

### Rotating partition

Do not close the door while the rotating partition is opened out to the front.

If you open or close the doors with force, the rotating partition may open to the front. Open and close the doors slowly. (Otherwise it may be damaged.)

### Air outlet

The interior light uses 10 LEDs.

If food with a high water content is placed near the air outlets, it may freeze.

► Page 35

### Adjustable pocket (large)

Vertically adjustable to 2 positions

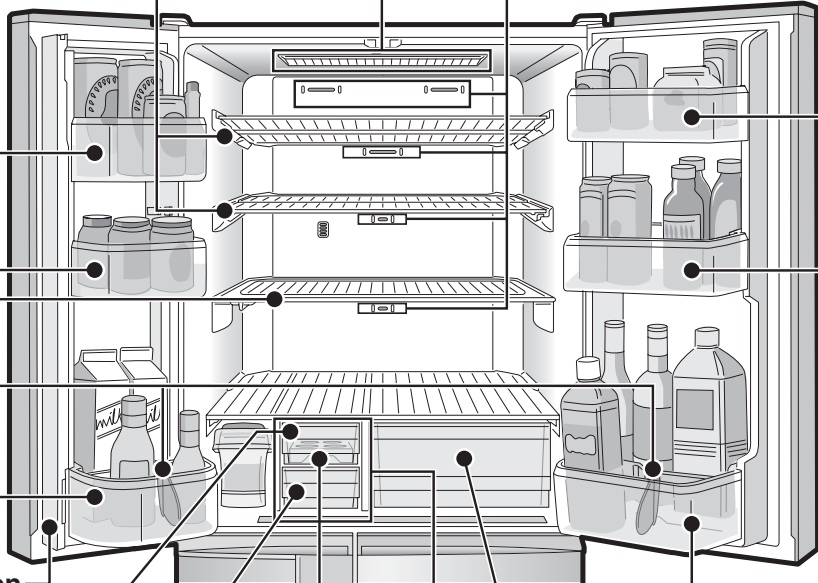

### Egg shelf

### Small item case (lower)

### Small item case (upper)

### Bottle pocket (large)

Chilled (-3 to 3°C)

### Chilled Egg compartment

### Slide chilled case

Store food such as meat, fish, processed food (fish cake, ham, etc.) and yoghurt.



- Cannot adjust the temperature.
- Do not store food that is easy to be frozen.



Do not leave food hanging over shelves or pockets. Do not place glass bottles that cannot fit all the way to the bottom at the front of the bottle pocket.



Do not attach a case that you purchased separately onto the outside of a pocket.



Do not close the door while food is in front of the slide chilled case or the small item case.



Fully stow away the cases.

It may keep a door ajar and reduce the cooling performance, or food may fall and cause an injury or damage to a case or lid.

### Auto closer

With the door of refrigerator room open at an angle of about 20 degrees or less, the door closes automatically.

- The auto closer is not intended to automatically close doors kept open slightly (doors left ajar). The door may stop before closing completely if you swing close the door too softly.
- The amount of food inside the compartment may affect the closing speed.

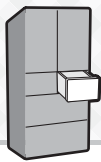

## Versa Compartment

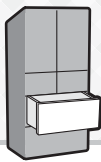

## Freezer Compartment



## Vegetable Compartment

### Versa compartment

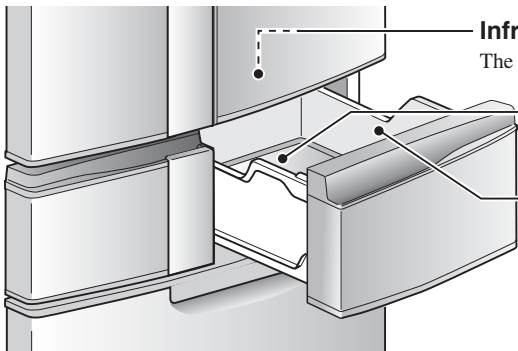

#### Infrared sensor

The food temperature is detected with an infrared sensor.

#### Aluminum tray

The cold tray quickly cools the food.

#### Versa case

#### Caution

Do not stack food higher than the case.

- The door may not be closed.
- Food may be thawed.
- Food may be damaged.

### Freezer compartment

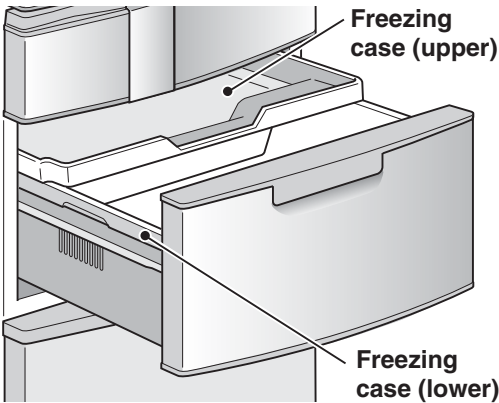

#### Freezing case (upper)

#### Freezing case (lower)

#### Caution

Do not place tall objects in the freezing case (lower).

- Food or the freezing case (upper) may be damaged.
- The door may not be closed.

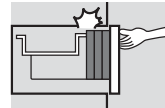

Do not put in plastic drink bottles other than those meant for freezing. Do not place glass bottles in freezer.

- The frozen contents may break the bottle.

▶ Page 5

### Vegetable compartment

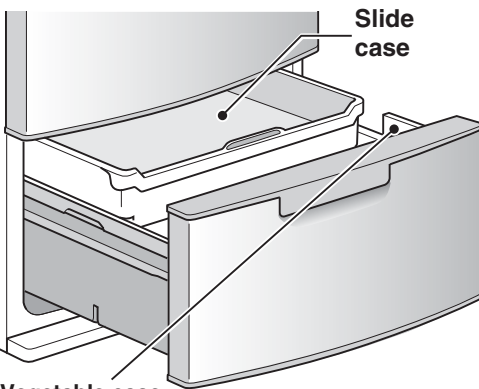

#### Slide case

#### Vegetable case

Bathed in light to increase the nutrients! Vitamins boosted up   
**The orange LED is always on.**

**Storing fruit and vegetables in plastic wrap keeps them even fresher.** 

- Vegetables stay alive even after harvest. Being bathed in light, their nutrients are boosted up.
- There is almost no vegetable, fruit, drink or seasoning that cannot be preserved or stored being exposed to light.
- The vegetable nutrients are increased even with a weak light, so packaging does not need to be removed (except when the packaging completely blocks off the light).
- The vegetable nutrients are not increased forever. The preservation also depends on the freshness at the time of purchase. Eat vegetables when they are as fresh as possible.
- Because the vegetable compartment has a high humidity, fogging or condensation may form on the roof of the vegetable compartment or the bottom of the cases. Condensation forming on the bottom may make the case dirty, so wipe it off with a dry cloth.

\*The orange LED is equipped to the MR-EX655W only (not equipped to the MR-EX562W).

#### Caution

Do not stack food higher than the case.

- Food or the slide case may be damaged.
- The door may not be closed.

Because the vegetable compartment has a high humidity depending on the amount or types of vegetables, frost or condensation may form on the roof of the vegetable compartment or the surface of the cases.

When condensation forms, wipe it off with a dry cloth.

Before Use

Placing Food Inside

Operation

Cleaning

Troubleshooting

• When a door is open, you will be informed with the door alarm, interior light, and compartment display area. ▶ Page 32

\*Illustrations for MR-EX655W are used in explanations. Depending on the refrigerator model, the capacity, dimensions and shape may differ, but usage is the same.

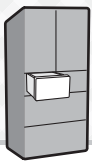

# Ice Making Compartment (Automatic Ice Maker)

## Ice making compartment

Before Use

Placing Food Inside

Operation

Cleaning

Troubleshooting

**Water tank cap**

**Water tank lid**

The lid can be set on the tank in both directions, facing the front or rear.

**Water tank (about 1.2 L)**

**Tank Pipe**

**Water supply pump**

**Optical catalyst and lead-cleaning filter**

**Ice tray**

It can be removed for cleaning.

**Ice making compartment label**

**Ice server**

**Water tank setting position line**

This is the guideline for the water tank setting position.

Push in the water tank until it makes contact with the inner side. Make sure that the line can be seen in front of the water tank.

**Water supply pipe**

**Ice tray lock lever**

**Soundproof mat**

Reduces the sound of dropping ice. Do not dispose of it.

**Ice storage box**



## Ice making precautions

Do not place objects at the rear of the ice storage box.

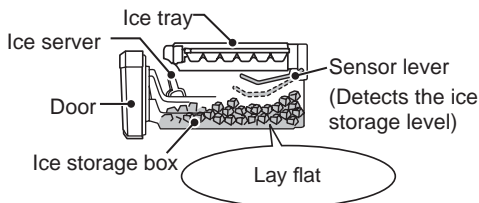

- Store food lower than the red line of the ice making compartment label (because it may cause an ajar door, malfunction or damage). Set the ice making compartment to "STOP" mode when storing food.

► **Page 17**

- The level of the ice storage is checked automatically by the sensor lever, and ice making is stopped when the ice reaches a certain level (about 80 to 140 ice cubes). To detect the ice storage level correctly, make sure that the ice is flat and that the ice server is kept in its storage position in the front right of the ice storage box.

**Caution**

- Clean the ice maker periodically to ensure that the ice is pure and delicious.

► **Pages 26 - 27**

- Do not pour anything other than cold water into the water tank, such as warm water, juice, tea, soft drinks, or other liquids (the tank can resist heat up to 60°C).

Pouring anything other than cold water into the tank may cause damage.



- Do not pour water directly into the ice tray to make ice. Unfrozen water in the ice tray may fall into the ice storage box, and the ice may join not forming cubes.
- When ice is made using water with a high mineral content, such as mineral water, white deposits (white crystals) may form in the ice. This is the crystallized mineral content and is not harmful.

## 1 Check that **ICE TRAY** is not displayed.

- Check this after touching  to light up the display.
- If the lamp is on, insert the ice tray and lock the ice tray lock lever. Inserting ice tray ► [Page 26](#)

## 2 Remove the water tank from the refrigerator compartment.

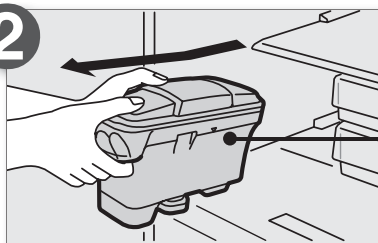

**Water tank**

When using it for the first time, or if you have not made ice for more than a week.

- Wash the water tank, water supply pipe, and ice tray. Odours or dust may be adhered to the parts. [How to wash](#) ► [Page 26](#)

Hold the tank with both hands.

## 3 Slide the water tank cap and pour water into the water supply port up to the full position.

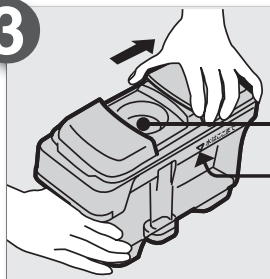

**Water supply port**

**Full position**

**Do not pour water above the full position.**

- If water is filled beyond the full position, water may spill when you carry or tilt the tank. Further, it may cause the water channels in the ice tray to freeze, and the ice to join together or form a protrusion.

WARNING-Fill with potable water only.

## 4 Close the water tank cap, return the water tank to its original position, and close the door of the refrigerator compartment.



Carry the water tank with both hands and insert it horizontally until it makes contact with the rear side.

- Check that there are no foreign objects between the tank holder and the water supply pipe area. It may cause freezing.

**How to check** ► [Page 26](#)

- Push in the water tank until it touches the rear side. Setting the water tank incorrectly may prevent ice from forming.

**The ice making time for a single batch is about 2 hours.**

When you want to make ice quickly ► [Page 17](#)

### Caution

- If **ICE** of the compartment display blinks. Ice tray is operating. Do not remove the ice tray while it is operating. Doing so may cause injury. If you release the ice tray lock lever while the ice tray is operating, you will be alerted by a repetitive buzzer.

### About the ice



- About 10 to 12 ice cubes can be made each time. The ice cube size and the number of ice cubes in one batch depend on various factors, such as the amount of water in the water tank.
- If the ice is stored in the ice storage box for a long time, the ice cubes may join together or shrink (due to a phenomenon called sublimation).
- If you try to crush ice that has joined together, be careful not to injure your hands.



# How to Use the Operation Panel

Before Use

The operation panel is a touch-style panel operated by touching the operation items with a finger.

- To save power, all displays other than  are usually turned off (It turns off if there is no operation for about 30 seconds).
- To check the setting status, touch  to light up the display.
- The blue light at the top left corner of the  "Soft-Freezing" icon lights up at the time of purchase.

Placing Food Inside

Operation

Cleaning

Troubleshooting

## 1 Touch .

- When you keep the door of the refrigerator open, touch  for about 1 second (until the buzzer sounds once).

## 2 Touch the icon that you prefer from the icon list.

- When you touch an icon by mistake, touch . The display returns to the previous state.

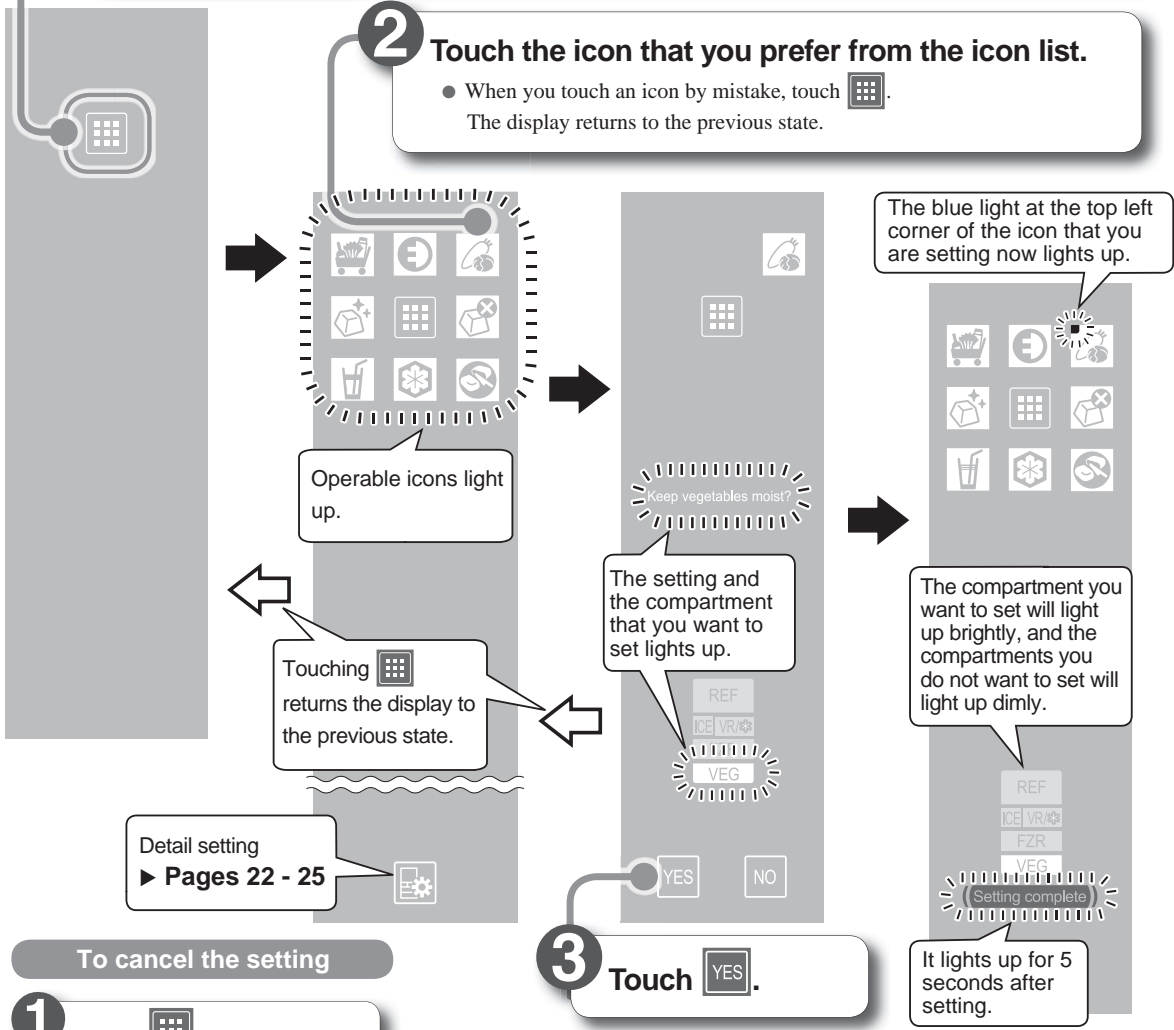

### To cancel the setting

#### 1 Touch .

#### 2 After touching the icon that you want to cancel, touch .

#### 3 The blue light at the top left corner of the icon turns off. Example: → .

**Note**

- Operate this operation panel with a finger.
- In the following cases, it may not operate properly.
  - When the operation panel or fingers are wet or dirty
  - When operating with gloves or band-aid on
  - When using a sharp object to operate it
- If the display does not change even though you are touching an item, touch the item again after moving away your finger once. If the interval between each touch is too short, it may be misdetected (as a continuous touch). Detecting sensitivity does not change even if an item is touched hard.
- The response may vary, depending on the surrounding temperature, humidity, the health condition of the person who operates it, and the operating condition of neighboring electric appliances.

# Rapid Cool Bulk Shopping Keep Vegetables Moist

## Cool Drinks Quickly

### Rapid Cool Bulk Shopping

Automatically select the compartment whose door was opened and closed, and then cool it down quickly.

**1** Touch  → Rapid cool bulk shopping? will be displayed.

**2** Touch .

 (Setting complete) is displayed, the blue light at the top left corner of the icon lights up, and then the setting is finished.

- This stops automatically about 2 hours after setting.



Usable in the refrigerator, freezer, and vegetable compartments.

### Keep Vegetables Moist

The vegetables can be freshly kept for a long time in the temperature suitable for leaf vegetables.

**1** Touch  → Keep vegetables moist? will be displayed.

**2** Touch .

 (Setting complete) is displayed, the blue light at the top left corner of the icon lights up, and then the setting is finished.



Usable in the vegetable compartment.

### Cool Drinks Quickly

Quickly cool down drinks or food in the refrigerator compartment.

**1** Touch  → Cool drinks quickly? will be displayed.

**2** Touch .

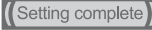
 (Setting complete) is displayed, the blue light at the top left corner of the icon lights up, and then the setting is finished.

- This stops automatically about 2 hours after setting.



Usable in the refrigerator compartment.

Before Use

Placing Food Inside

Operation

Cleaning

Troubleshooting

# Power Saving

## Set Energy Saving Mode (ECO MODE)

An appropriate timing is selected for each compartment and the power-saving mode is performed automatically. With the power saving operation, the temperature of the compartment is set a little higher while compartment operations are performed.

- Power-saving is canceled for compartments with doors that are frequently opened and closed, as well as the compartments on the fast cooling setting.

**1** Touch . → Energy Saving Mode? will be displayed.

Usable in all compartments.



**2** Touch .   
 (Setting complete) is displayed, the blue light at the top left corner of the icon lights up, and then the setting is finished.



- As for the compartment in power saving mode, **ECO** lights up.
- If 30 seconds pass without any operations, the display turns off.



### Check the power-saving condition.

When checking the power saving conditions of each compartment, touch   to switch the display area by compartment and you can check the compartment in power-saving mode by the **ECO** display.

Example: When the freezer compartment and the refrigerator compartment are in power-saving mode (ECO level 2)

Display example	★ ★	ECO ★ ★	★ ★	ECO ★ ★
Compartment display				

**ECO** lights up to indicate the compartment in power-saving mode.



### ECO GUIDE

The ECO Level of the previous 24 hours is determined by factors such as the temperature settings of the compartments and the frequency of opening and closing the doors, and is indicated by the number of ★ marks.

ECO level	Level 0	Level 1	Level 2	Level 3
ECO GUIDE				

\*  represents a blinking display (such as when the doors are opened and closed frequently or the surrounding temperature of the refrigerator is hot).

- The ECO Level is indicated in 4 levels from 0 to 3. (Eco-friendly use can save power and increase the ECO level.)
- The ECO Level is updated about once every hour. (If there is no change in the ECO Level, the number of the ★ mark does not change.)
- At the time of purchase, level 1 is displayed.
- The ECO GUIDE is displayed even when Energy Saving Mode is not set.
- After a door is closed, the ECO GUIDE and the **ECO** display light up for about 30 seconds (then they go off).
- When Energy Saving Mode is set, the compartment in power saving mode will light up.

\*Even though Energy Saving Mode is set, the display does not light up if the compartment is not on the power-saving mode.



### How can I increase the ECO level?

#### Set Energy Saving Mode

When the temperature inside the refrigerator is stable, the power-saving operation is performed automatically. This is not set initially.

#### Set Power Save Mode

Performs the power-saving operation by reducing refrigerating capacity. This mode can be set for the ice making and versa compartments. ▶Pages 24 - 25

#### Set the temperature relatively high

By setting the temperature of each compartment relatively high,

power consumption can be reduced. We also recommend setting the versa compartment to Soft-Freezing.

#### Do not open the doors more than necessary, and close them as soon as possible

If doors are opened frequently or are kept open for a long time, cold air escapes from the refrigerator and more power is consumed.

- Even when a door is open only slightly, it can cause frost or condensation, reduce the cooling performance, or generate water drips.







# Changing the Setting of the Ice Making Compartment



When the blue light does not light up on either icon, the compartment is in the regular ice making mode.

- Regular ice making is set at the time of purchase.



## Making ice quickly (quick ice making)

The ice making time for a single batch is 60 to 80 minutes.

**1** Touch . → **Rapid ice making?** will be displayed.

**2** Touch **YES**.  
**(Setting complete)** is displayed, the blue light at the top left corner of the icon lights up, and then the setting is finished.

- Setting the compartment to "quick ice making" cancels "stop ice making."



Makes ice quickly.

### About quick ice making

- In the following cases, quick ice making is stopped automatically.
  - When the ice storage box is full (about 80 to 140 ice cubes)
  - When there is no water in the water tank
  - When about 10 hours have passed in quick ice making mode
 The blue light at the top left corner of the icon turns off.
- Example: →
- The sound of the refrigerator running gets louder during fast cooling, because it is operating at high speed.
- It may take more than 24 hours to make ice immediately after installation, even in quick ice making mode.
- When quick ice making is performed, the ice may split or crack because the freezing is performed quickly.

### Approximate ice making time

Quick ice making: 60 to 80 minutes Regular ice making: about 2 hours

- The ice making time is the approximate time for a single batch (10 to 12 ice cubes).
- In addition to the surrounding temperature, water type, and water volume and temperature in the water tank, ice making times may vary with the following conditions, and be longer than those described above.
  - In winter or at other times when the surrounding temperature is low
  - When the doors are frequently opened and closed
  - When the freezer compartment is set to "L"
  - When setting to Energy Saving Mode ▶ **Page 16**
  - When the ice tray is pulled out and reinserted during ice making
- When **PWR SAVE** is displayed, ice cannot be made. Cancel the setting. ▶ **Page 24**



## Stopping ice making (stop ice making)

Select this setting when not making ice for a long time or cleaning the ice making compartment.\*1

**1** Touch . → **Stop making ice?** will be displayed.

**2** Touch **YES**.  
**(Setting complete)** is displayed, the blue light at the top left corner of the icon lights up, and then the setting is finished.

- Setting the compartment to "stop ice making" cancels "quick ice making."

When you want to make ice again—

Touch and **NO** in order.

- The blue light at the top left corner of the icon turns off and the compartment is set to the regular ice making mode. →



Stops making ice.

\*1: For short term storage of frozen food. Not to be used for long term storage of frozen food or ice cream.



# Changing the Setting of the Versa Compartment

Before Use



When the blue light at the top left corner of the icon is not on, the versa compartment is set to freezing.



When the blue light at the top left corner of the icon lights up, the versa compartment is set to Soft-Freezing.

- Soft-Freezing is set at the time of purchase.
- "Tips for Supercool Freezing and Soft-Freezing" ► **Pages 20 - 21**

Placing Food Inside



## Setting Soft-Freezing

■ When the versa compartment is set to freezing

1

Touch

Now **Normal freezing** and **Soft-freezing** are displayed in order.  
Select the setting above



The setting can be switched between Soft-Freezing and freezing.

2

Touch **YES**.

**(Setting complete)** is displayed, the blue light at the top left corner of the icon lights up, and then Soft-Freezing is set.

- Soft-Freezing **M** is the initial setting. ► **Page 23**
- Touching **NO** sets the compartment to freezing.

Operation

Cleaning



## Setting Freezing

■ When the versa compartment is set to Soft-Freezing

1

Touch

Now **Soft-freezing** and **Normal freezing** are displayed in order.  
Select the setting above

2

Touch **YES**.

**(Setting complete)** is displayed, the blue light at the top left corner of the icon lights up, and then it will be set to freezing.

- Freezing **M** is the initial setting. ► **Page 23**
- Touching **NO** set the compartment to Soft-Freezing.

Troubleshooting



## Setting Supercool Freezing

Food can be frozen without losing its taste and texture by using the "Supercool Freezing" mode.

After supercool freezing, store the meat and fish with Soft-Freezing so that you can easily cut them.

• "Tips for Supercool Freezing and Soft-Freezing" ► Pages 20 - 21

1

Check if the blue light at the top left corner of  is on.

- Supercool freezing cannot be performed during the freezing setting. Switch the versa compartment setting to Soft-Freezing. ► Page 18
- Touch  to light up the blue light at the top left corner of the icon, and then wait until the temperature stabilizes (after about 2 hours) before performing 2 operation.



Usable in the versa compartment.

2

Store food in the versa compartment and touch .

3

Touch .

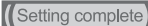
 is displayed, the blue light at the top left corner of the icon lights up, and then the setting is finished.



- If  is touched, the setting is canceled.

• **Supercool freezing finishes automatically after about 3 to 12 hours.** (The time varies depending on the amount, temperature and type of food.)

After supercool freezing finishes, the food is stored with Soft-Freezing. (Meat, fish, etc. can be stored for 2 to 3 weeks.)

• If you want to store the food for a long time, move it to the freezer compartment after supercool freezing has finished. (Meat, fish, etc. can be stored for about 1 month.)

### Note

- When a display other than  turns off during supercool freezing,  lights up.
- The door of the versa compartment can be opened and closed even during supercool freezing.
- You can use supercool freezing even when other foods are still inside.
- Supercool freezing cannot be performed during Power Save Mode or the freezing setting.
- Even after supercool freezing has finished, the food may not be completely frozen. (With supercool freezing and Soft-Freezing, food is frozen at about -7°C, so it takes about 24 hours for the food to freeze completely.)
- When adding foods to be stored, refrain from opening the doors often.
- Supercool freezing may not be possible or the degree of freezing or freezer burn may vary depending on the food type, cooking method, storage arrangement (stacking, storage location), the amount of food, and the storage time.
- Depending on how much sugar, salt, moisture, or fat the food contains, freezing may not be possible or the food may harden when frozen (cannot be cut immediately with a kitchen knife).
- If the food has frozen too hard, leave it for about 5 to 15 minutes at room temperature and you should be able to cut it with a kitchen knife.
- Adjust the temperature according to how the food is frozen. ► Pages 22 - 23

Before Use

Placing Food Inside

Operation

Cleaning

Troubleshooting

# Tips for Supercool Freezing Soft-Freezing

Before Use

Placing Food Inside

Operation

Cleaning

Troubleshooting

## Take it out and cook immediately !

Thinly sliced meat  
**Bacon**

Without thawing

You can easily slice them.



You can easily separate them one by one and slice them finely. They will thaw while basting.

**Ground meat**

Only the necessary amount



It can be cut with a kitchen knife easily. You can cut out the necessary amount. It can be cut into cubes for thawing.

**Cutlets**

You can easily separate them.



You can easily separate them. No need for dividing them by the amount per serving and wrapping them. Bake them at low heat without thawing.

## Supercool freeze to savory taste !

Freshly cooked rice

Keep savory taste

Glutinous texture



Divide it by the amount per serving, wrap them while still warm, and then supercool freeze them. Use Soft-Freezing when the time to preserve is about 2 weeks.

Steak meat  
**Blocks of meat**

Prevents meat drip



Cut into 100 to 400 grams and supercool freeze them. Keep taste and nutrients of food.

**Potatoes Broccoli**

Removes heat



Boiled vegetables for use in croquettes or salads can also be supercool frozen. The texture is kept frozen.

## Easy dessert recipe using fruits !

**Frozen fruits**

Easy preparation

Sweet fruits are recommended.



Cut fruits into bite-size pieces and Supercool Freezing them.

**Frozen yogurt**



Sweetened yogurt can be supercool frozen while still in its cup. It becomes a fine and smooth, ice cream-like texture.

**Jam**

No need for cooking



Put strawberries and kiwis into a container and mash them thoroughly. Mix in sugar and supercool freeze the mixture.

## Tips for Supercool Freezing

### ① Put foods at the same time.



We recommend that hot food be separated from the frozen food and placed at the front.



- The hot food may touch and thaw the frozen food.
- If hot food and food below room temperature are placed inside at the same time, priority is given to cooling the hot food.

If more food is added afterward, the supercool freezing may not work.

### ② Lay the food out flat on top in the versa compartment.

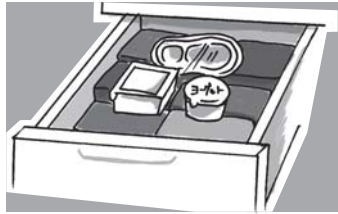

The infrared sensor measures the temperature of food from the top of the versa compartment.



Arrange the food in a way that makes it easy for the sensor to measure the temperature.

### Food not suitable for Supercool Freezing

- **Food that has already thawed once**  
The texture and quality cannot be guaranteed.
- **Food that cannot be frozen**  
(Konjac (devil's tongue), tofu, milk, raw eggs, etc.)  
Preservation of the pre-freezing texture and quality cannot be guaranteed.
- **For preserving groceries like frozen foods and ice cream.**  
Store them in the freezer compartment.



### Caution Do not store food that is hotter than 80°C.

If food is too hot, it may deform nearby containers. Also, when food is too hot to hold with your bare hands, be very careful not to burn yourself. (Freshly cooked rice is about 70°C.)

### Note

- When Soft-Freezing after freezing, or freezing after Soft-Freezing, use the food within a short period of time (about 1 to 2 weeks).
- After supercool freezing has finished, if you want to store the food for a long time, move it to the freezer compartment quickly.
- When fruit is thawed it does not return to its original condition. Eat frozen fruit without thawing it.
- If fruit is stored for more than a week with Soft-Freezing, its taste may change. To enjoy the fresh texture, we recommend eating within 2 to 3 days.
- It can be cut 2 to 5 hours after transferring from freezing to Soft-Freezing.
- Avoid using aluminum foil or paper wrapping, because it interferes with accurate measurement of the food temperature.

### Meat sauce

You only have to scoop out the necessary amount.



Supercool freeze in storage containers. Scoop out only the necessary amount and dress the pasta with it to make a meat sauce pasta.

### Curry Simmered meat and potatoes

You can batch cook



Leftover curry and simmered meat and potatoes in storage containers can be supercool frozen while still hot. Even food containing potatoes can be stored without losing its taste.

### Smoothie



Cut apple into large bite-size pieces, and kiwi into circular slices. Supercool freeze them. Put the supercool frozen apple and kiwi into a blender with milk and some honey.

### Storage containers

- When storing food in sealed containers, fill food tightly as much as possible until the container is completely full.
- Do not store in a glass container. It may break down.



# Setting the Details

## Change the temperature of each compartment

The temperature of each compartment can be adjusted according to the conditions of use.

- Touch to light up .
- Initial condition (at the time of purchase) : refrigerator, freezer, and vegetable compartments ... "M," versa compartment ... "Soft-Freezing/M"

Before Use

Placing Food Inside

Operation

Cleaning

Troubleshooting

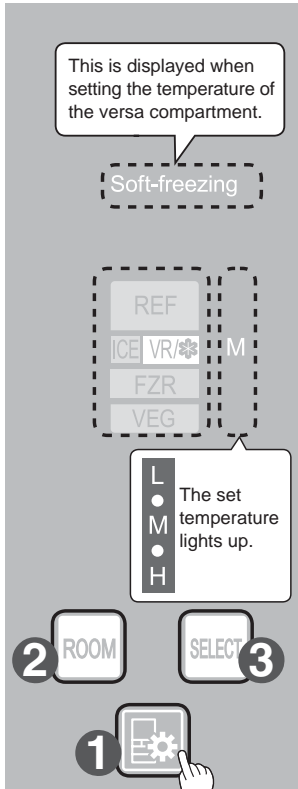

\* This is a display example when the versa compartment is set to "Soft-Freezing M".

**1** Touch .

**2** Touch to light up the compartment display that you want to set the temperature for.

The compartment display changes each time the button is touched.



- is displayed at the time of purchase.
- In addition to the compartment display, the temperature settings of the compartments are displayed.

**3** Repeatedly touch to set the temperature.

- The temperature setting of each compartment ► [Page 23](#)

### Note

- The temperatures described here are measured in the lower centre of the refrigerator after the temperature has stabilized when the surrounding temperature is 30°C and the doors are closed without any food inside. The temperature fluctuates with factors such as food storage conditions and how often the doors are opened and closed.
- Before and after defrosting, the temperature inside the refrigerator may drop or rise temporarily.
- If food in the refrigerator compartment freezes in the following kinds of situations, set the refrigerator compartment temperature on to .
- When the temperature setting of the compartments is
- In winter or at other times when the surrounding temperature is 5°C or less

## ■ The temperature settings for the refrigerator, freezer, and vegetable compartments

The display changes each time the icon is touched and temperature can be set to 5 different levels.

Temperature setting	REF Refrigerator compartment	FZR Freezer compartment	VEG Vegetable compartment
L	About 6°C	About -16°C	About 9°C
L	About 5°C	About -17°C	About 8°C
M	About 3°C	About -19°C	About 6°C
H	About 1°C	About -21°C	About 5°C
H	About 0°C	About -22°C	About 3°C

- \* The freezer compartment temperature is different from the freezing temperature of the versa compartment.
- To control the temperature more precisely ► **Page 33**

## ■ Ice making compartment settings







The display changes each time the icon is touched.

Ice making setting	Application
ICE	● When you want to make ice
ICE STOP	<ul style="list-style-type: none"> <li>● When not in use for a long time</li> <li>● For cleaning</li> <li>● When you want to use as a freezer compartment</li> </ul>

- \* Quick ice making cannot be set in the detail setting.
- **Page 17**

## ■ The temperature setting of the versa compartment

The display changes each time the button is touched and temperature can be set to 6 different levels.

Temperature setting	VR/❁ Versa compartment	Application
Soft-freezing	L	<ul style="list-style-type: none"> <li>● For frozen food that is too hard to cut</li> <li>Store food with a high moisture content on <b>L</b>.</li> <li>• Boiled vegetables</li> <li>• Large blocks of low-fat meat</li> </ul> 
	M	<ul style="list-style-type: none"> <li>● The optimum temperature for Supercool Freezing</li> <li>The food is easy to cut even when frozen.</li> <li>Can be frozen in its package.</li> </ul> 
	H	<ul style="list-style-type: none"> <li>● For food that is difficult to freeze</li> <li>Store food that has a high salt or sugar content on <b>H</b>.</li> <li>• Food pickled in soy sauce or miso</li> <li>• Cod roe</li> </ul> 
Normal freezing	L	<ul style="list-style-type: none"> <li>● For preserving food containing a lot of salt or sugar</li> <li>Enjoy the texture of the food.</li> </ul> 
	M	<div style="border: 1px solid black; padding: 5px; margin-bottom: 5px;">Ice cream or frozen food that was purchased cannot be stored in modes <b>L</b> or <b>M</b>.</div> <ul style="list-style-type: none"> <li>● For preserving food that was frozen at home</li> </ul> 
	H	<ul style="list-style-type: none"> <li>● For preserving frozen food and ice cream that were purchased</li> <li>Preserves ice cream at the optimum hardness so that it is easy to eat.</li> </ul> 

- \* The freezer compartment temperature is different from the freezing temperature of the versa compartment.
- \* After changing from freezing to Soft-Freezing, it takes some time for the temperature inside the refrigerator to stabilize (about 2 hours).
- \* If you touch , the setting will be changed to either Soft-Freezing **M** or freezing **M**. ► **Page 18**
- To control the temperature more precisely ► **Page 33**



# Setting the Details (Continued)

Before Use

Placing Food Inside



Operation

Cleaning

Troubleshooting





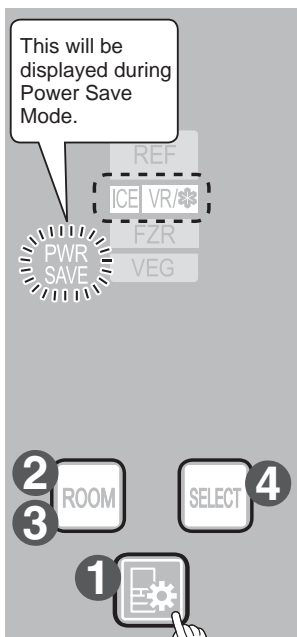

## Set Power Save Mode

This function reduces freezing capability of the set compartment for the purpose of power saving.

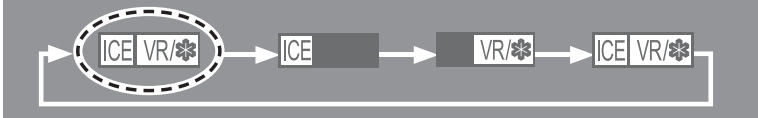

- Can be set for the ice making compartment and the versa compartment.
- If the ice making compartment is set to Power Save Mode, it is automatically set to "stop ice making." (Ice cannot be stored.) Empty the water from the water tank as well as the water and ice from the ice tray and the ice storage box, and then select Power Save Mode (the operation in "When not in use for a long time" ② - ⑤ ▶ Page 30).
- Touch  to light up .



\*This is a display example

- 1 Touch .
- 2 Touch  for about 3 seconds (until the buzzer sounds twice).
- 3 Touch  to light up the compartment display that you want to set.  
The lit compartment is set to Power Save Mode.  
The display changes each time the button is touched.  

  -  represents a blinking display. This is the condition where Power Save Mode was canceled.
  - Power Save Mode is canceled at the time of purchase.
- 4 If  is touched,  is changed from blinking to staying lit, and then the setting is finished (the buzzer sounds twice).
  - If the ice making compartment is set to Power Save Mode,  is displayed.
  - If 30 seconds pass without any operation panel operations, all displays turn off without being set.

### To cancel the setting

- 1 Select the versa compartment or ice making compartment, and then touch .
-  goes off when the setting is canceled.
- If the temperature setting of the compartment is adjusted, the setting will be canceled.
  - The cancellation can also be performed if  is selected after steps 1 and 2 of the setting procedure.



## Food that can be stored in Power Save Mode

(Dry foods) Seaweeds, seasoning powder, coffee beans, nuts, dry noodles, (pasta, vermicellifine noodles, etc.) etc.

(Seasonings) Salt, sugar, spice powder, etc.

(Grains) Rice, wheat, potato starch, etc.

(Sweets) Dry confectioneries, chocolates, cookies, etc.

- In Power Save Mode, the freezing temperature is set to between about -10°C and 0°C.
- It is not suitable for storing ice, fresh food, frozen food, ice cream, and food frozen at home. Move food from the versa compartment to the freezer compartment in advance.
- Check the items in the compartment before setting.
- Temperature may be lower when the ambient temperature is low, such as during winter, or when the freezer compartment is set to high.
- Do not store food higher than the ice storage box into the ice making compartment (because it may cause an ajar door, malfunction or damage).

Before Use

Placing Food Inside

## ■ The operation panel display during Power Save Mode setting

When Power Save Mode is set, there are icons that do not light up on the operation panel.

When an icon turns off, that means it is not operable. Cancel Power Save Mode before setting. ► **Page 24**



When the versa compartment is set to Power Save Mode



When the ice making compartment is set to Power Save Mode



When the versa compartment and the ice making compartment are set to Power Save Mode

Operation

Cleaning

Troubleshooting

# Cleaning the Automatic Ice Maker

Clean the ice maker periodically to ensure that the ice is pure and delicious.

**Prevents formation of water scale and mold.**

\* Do not use a dishwashing machine, because it may deform the parts.

Before Use

Placing Food Inside

Operation

Cleaning

Troubleshooting

once a week

## Water tank

1

**Remove the lid and wash it.** (Upper temperature limit about 60°C)

\* If mold forms easily in the certain types of water, clean about 2 or 3 times a week.



Align the mark on the water tank cap with the mark on the lid, and remove it.

When using bleach to clean the water tank and lid, follow the product instructions.

once a month

## Water supply pipe and tank holder

1

**Pull out the water supply pipe and wipe the tank holder with a clean cloth.**

- Do not pour water into the tank holder. Doing so may cause a malfunction.

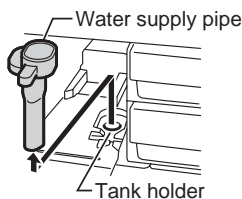

2

**Disassemble and wash the parts.**

- Rotate and remove the aluminum pipe.
- \* White minerals or chlorine accumulation may be adhered to the parts, this is not abnormal. Wash off such substances and reuse the parts.

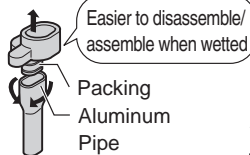

Easier to disassemble/assemble when wetted

3

**Follow the procedure in reverse to return the parts to their original positions.**

- Push in the water supply pipe firmly so that there is no unevenness. Using the water supply pipe while it is unevenly set may cause a malfunction.
- If the water supply pipe is not installed, the food inside the refrigerator compartment may freeze.

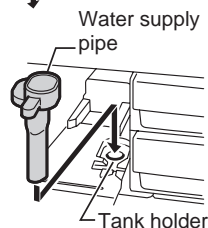

4

**Check that there are no foreign objects between the water supply pipe and the tank packing or tank holder.**

- If the parts are not inserted firmly or there are gaps due to foreign objects, it may cause abnormal noise or prevent ice from forming. It may also cause the water in the water tank or food in the refrigerator compartment to freeze.

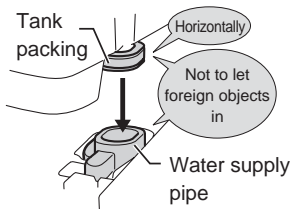

1-2 times a year

## Ice tray

1



Set to "STOP" ice making mode. ▶ Page 17

- Check that the blue light at the top left corner of the icon is on.

2

**Open the door of the ice making compartment and unlock the ice tray lock lever.**

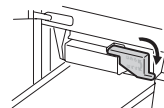

- When the ice tray lock lever is unlocked the ICE TRAY display turns on.
- If the alarm sounds continuously when unlocking the ice tray lock lever, lock the lever, close the door, wait for the blinking ICE to turn off, and then perform operation 2.

3

**Pull the ice tray towards the front and then remove it.**

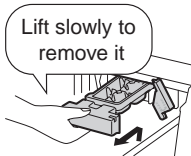

Lift slowly to remove it

- There is a risk of the water spilling. Pull out the tray slowly.

4

**Empty the ice tray and wash it.**

- After washing the tray, dry off any moisture.

5

**Push in the ice tray until it makes a clicking sound, and then lock the ice tray lock lever.**

- Check that ICE TRAY is off. If the lamp is on, check the setting status such as the position of the ice tray lock lever and the up and down orientation of the ice tray.

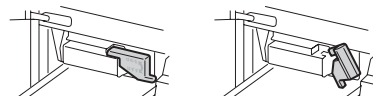

Ice tray lock lever is locked    Ice tray lock lever is released

6



Cancel "STOP" ice making mode. ▶ Page 17

# Do not use the following for cleaning.

Items such as sponges or scrubbers that may damage surfaces, or cleaners such as alkaline detergents, scouring powder, boiling water, petroleum or acid

once a week

## Tank pipe, water supply pump, optical catalyst and lead-cleaning filter

- 1 Pull out the tank packing (①) from the water tank.**
- 2 Pull out the tank pipe (②), and rotate and remove the water supply pump (③).**
- 3 Disassemble the parts and wash them.**

The impeller is made from a magnet. Wash it thoroughly to remove any foreign objects.

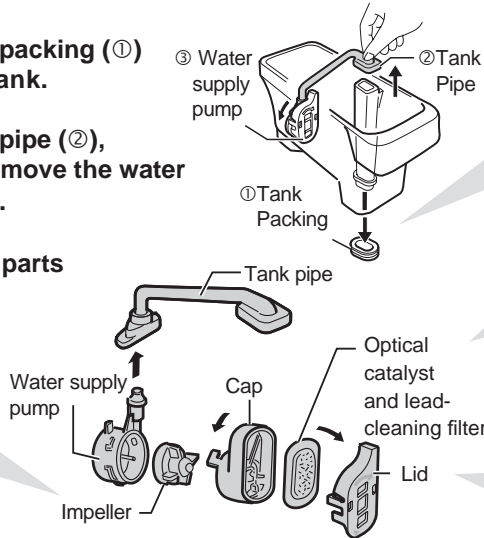

When setting, align the triangle mark on the tank with the triangle mark on the packing and fully put them together.

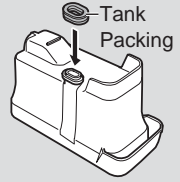

Do not use cleaners such as kitchen detergents (neutral), benzene or bleach to clean the optical catalyst and lead-cleaning filter.  
● Doing so may result in odours of the ice.

Remove the cap while opening the tab with your finger.

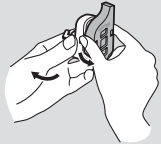





- 4 Return the water supply pump, tank pipe, tank packing to their original positions.**

### Procedures for returning the water supply pump and tank pipe to their original positions

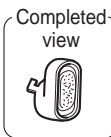
Incorrect assembly may prevent ice from forming, or increase the operation noise.

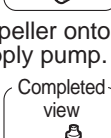
#### Assembling the water supply pump

- Fit the filter into the cap. 
- Fit the lid onto the cap. 
- Attach the impeller onto the water supply pump. 

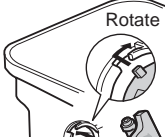
- Rotate and fix the tab (①) of the cap into the projection (②) on the water supply pump. \* Make sure that the impeller is inside. 
- Rotate and set the water supply pump onto the water tank. \* Align the triangle mark on the bottom of the water tank with the triangle mark on the filter and push in while making sure that there is no gap. 

#### Installing the tank pipe

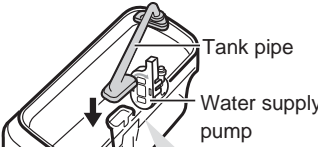
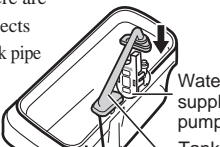
- Insert the tank pipe into the water tank.   
**Caution** Do not let foreign objects block the hole.
- Connect the tank pipe to the water supply pump. \* Check that there are no foreign objects between the tank pipe and the water supply pump. 

Before Use

Placing Food Inside

Operation

Cleaning

Troubleshooting

Note

- If the tank packing is not installed, it may cause the water in the water tank or food in the refrigerator compartment to freeze.
  - Replacement is not usually required for the optical catalyst and lead-cleaning filter. However, it may require replacement in the following cases.
    - When it clogs because something other than water was put in the tank
    - When it is damaged
    - When mold has formed
- To purchase a new filter, contact the retail store where you purchased the refrigerator.  
\* If mold forms easily in the certain types of water, clean about 2 or 3 times a week.

# Removing and Cleaning the Parts

Before Use

## Step 1 Before cleaning

Remove the power plug.



**Warning**  
Otherwise an electric shock or injury may be caused.

Wait at least 10 minutes before reinserting the power plug into the socket.  
If you insert the plug immediately, the mechanism will not function.

## Step 2 How to clean

- Wipe with a soft cloth soaked in warm water, or remove and rinse with water.
- When cleaning the operation panel, set it to the Child Safety Lock. ▶Page 31 (Wipe the operation panel with a soft, dry cloth.)
- For stubborn dirt, wipe using water mixed with a weak concentration of kitchen In particular, be sure to wipe off oily dirt because leaving it may damage



Do not use insecticide spray, alkaline or low alkaline kitchen powdered soap, alcohol, benzene, thinner, oil, acid, scrubbers. Doing so may cause the plastic parts (such as the door split, or damage or rust the doors or painted surfaces.

Placing Food Inside

## AUTO Shelf (Do not disassemble the AUTO Shelf, or use chemicals such as grease to clean it. Doing so may cause a malfunction.)

### Tray removal

- ① Push up the tray while pulling the 3 white tabs on the rear of the tray to the front with your finger.

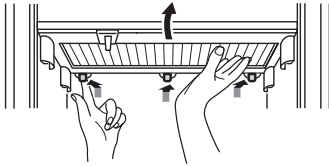

- ② Lift up the rear of the tray until the 3 front tabs and the 2 side tabs disengage.

\* There is a risk of the tray falling. Move it slowly.

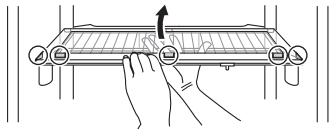

- ③ Pull out with both hands.

### Shelf removal

Remove the tray before performing this.

- ① Move the lever to the right end.



- ② Strongly push up each support, one by one. (4 locations.) (A clicking sound is made when the support disengages.)



If the supports are firmly set and difficult to disengage, tilt the inner tabs to the inner side.

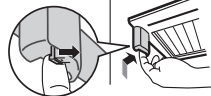

- ③ Remove from the refrigerator.

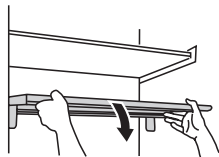

### Shelf installation

Remove the tray before performing this.

- ① Make sure that the lever is on the right side.



- ② Make sure that the 4 metal stoppers are fitted, and place the shelf lightly so that the 4 supports are aligned with the 4 metal stoppers.

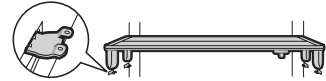

- ③ Push in each of the 4 supports in turn from above. (A clicking sound is made.)

- ④ Move the lever to the left and right and check that the AUTO Shelf is kept level when moved up and down. (If the shelf is not kept level, remove the AUTO Shelf and repeat steps ① to ④.)

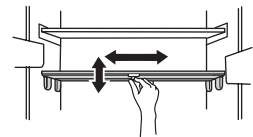

Operation

Cleaning

Troubleshooting

## Two-way flexishelf

Push in and lift up.

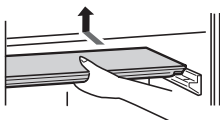

## Slide chilled case and small item case

- ① Fully pull out the case.
- ② Lift out to the front.

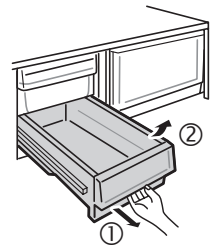
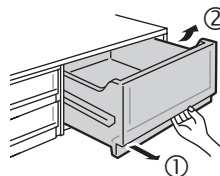

For installation, follow the procedure in reverse to the removing methods.

### Step 3 After cleaning and periodically

#### Check the power plug and cord

For safety, clean periodically.

- ① Unplug the power plug from the socket and check it.
  - Check for damage or abnormal heating on the power plug and cord.
- ② Remove any dust from the power plug and surrounding area, and then wipe with a dry cloth.
- ③ Firmly insert the power plug into the socket.

#### Warning

If the power plug or cord is damaged or dust accumulates, it may cause an electric shock or a fire.

detergent (neutral).  
the plastic parts.

detergents, scouring powder,  
boiling water, or similar substances.  
handles, caps and cases) to

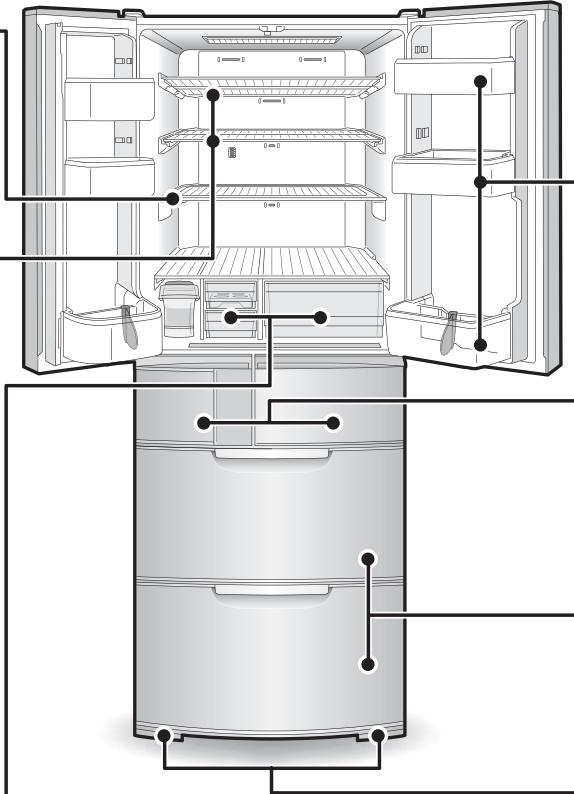

#### Adjustable pockets and bottle pockets

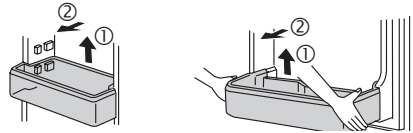

- ① Lift up the left and right of the pocket alternately.  
(The pockets are firmly installed.)
- ② Pull out to the front.

#### Shelf installation

- Make sure that the pockets are securely set.  
(Incorrect setting may cause a pocket to disengage and fall out, causing an injury.)

#### Ice making and versa compartments

- ① Fully pull out.
- ② Lift out to the front.

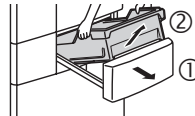

\* The illustration represents the versa compartment.  
The ice making compartment is the same.

#### Recessed portion of the drip gutters

Wipe off any dirt, dripping or condensation.

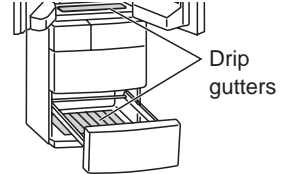

#### Freezer and vegetable compartments

- ① Fully pull out the door.
- ② Lift the upper case out to the front.

\* The illustration represents the freezer compartment.  
The vegetable compartment is the same.

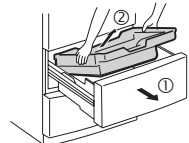

- ③ Pull out while slightly lifting up the door, and then tilt.
- ④ Lift the lower case out to the front.

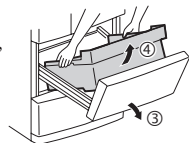

#### Adjustable support cover

- ① Push the left and right sides of the support covers inward alternately, and pull the support covers to the front to remove them.

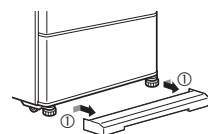

#### Refrigerator rear side and floor

- ① Remove the adjustable support cover.
- ② Turn the adjustable supports to raise them from the floor, and pull out the refrigerator. (We recommend laying out protective material on the floor to prevent the floor from being damaged. Also, be careful not to injure yourself.)
- ③ Remove the dust from the rear panels, walls and floor, and wipe off any dirt.  
(These areas are prone to buildup of dust and black dirt due to air convection. Periodical cleaning will also improve power efficiency.)
- ④ Check for water dripping on the floor.



#### Caution

Do not put your hands under the refrigerator. It may cause injury.

Before Use

Placing Food Inside

Operation

Cleaning

Troubleshooting

# Other Issues

Before Use

## A power outage occurred

- Minimize the frequency of opening the doors, and avoid adding more food.
- Operation panel settings other than the temperature settings may change. Check the settings. (Child Safety Lock, etc.)

Placing Food Inside

## To move the refrigerator or change its orientation

- ➊ Remove the adjustable support cover, and then rotate and raise the adjustable supports. ▶ Page 7
- ➋ Lay protective material under the casters and rear supports.
- ➌ Move the refrigerator in the forward and backward directions.
  - \* Dragging in any direction other than forward and backward may damage the floor.

Operation

## When not using the refrigerator for a long time

- ➊  Set to the "STOP" ice making mode. ▶ Page 17
  - Check that the blue light at the top left corner of the icon is on.
- ➋ Remove the water tank and empty the water.

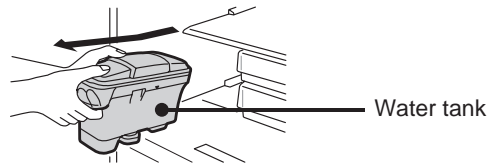

- ➌ Remove the ice tray and empty the water and ice.
  - For details on removal, see the page that describes the cleaning methods. ▶ Page 26
- ➍ Remove the ice storage box and empty the water and ice.
  - Do not dispose of the soundproof mat.

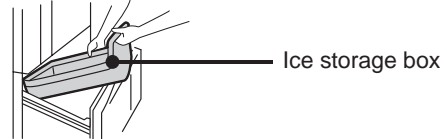

Cleaning

- ➎ Wash the water tank (water supply pump, tank pipe, optical catalyst and lead-cleaning filter), water supply pipe, ice storage box, soundproof mat, ice tray and ice server, dry them completely, and then return them to their original positions. ▶ Pages 26 - 27
  - If the water tank is not returned to its original position, the food inside the refrigerator compartment may freeze.

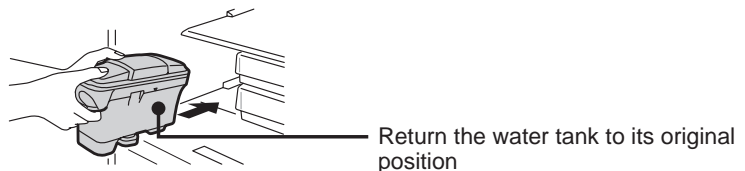

Troubleshooting

- ➏ Unplug the power plug, clean the interior of the refrigerator, and open the doors for 2 to 3 days to dry the inside.
  - \*If the refrigerator is not dried sufficiently, it may cause mold, odours, or refrigerant (gas) leaks due to condenser corrosion.

### Note

- Wash the water tank, water supply pipe and ice tray before making ice for the first time, or if you have not made ice for more than a week. Odours or dust may be adhered to the parts.

## To transport the refrigerator

- 1 Empty any water or ice from the water tank and ice tray. ► Pages 26 and 30
- 2 Wear protective gear (gloves).
- 3 Remove the adjustable support cover, and then rotate and raise the adjustable supports. ► Page 7
- 4 Remove the power plug
- 5 Lay towels under the drainage port and the lower rear edge of the refrigerator, and position a container or tray with a height of about 3 cm on the towels to collect the water.  
\*The towels prevent floor damage, and water from being spilled on the floor.
- 6 Tilt the refrigerator slowly to the rear by about 30 degrees, and drain the water from the evaporation tray via the drainage port on the lower rear side. (The evaporation tray is not visible from the outside.)
  - \* Because the refrigerator is heavy, the work must be performed by at least 2 people.
  - \* The work must not be performed by small children or people who are not capable of doing heavy work. Ask a specialist transportation company.
- 7 2 or more people should hold the hand-holds on the lower inside of the front and the upper side of the rear, and carry the refrigerator slowly.
  - Do not lay down the refrigerator on its side. (The compressor may be damaged.)

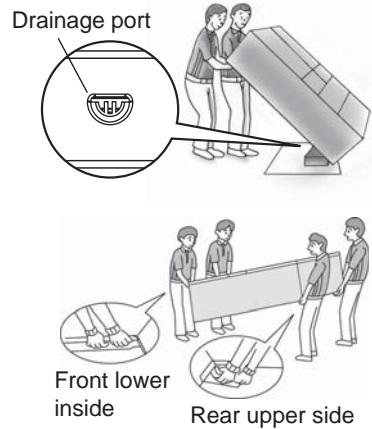

### When the transportation time is long, for example when moving house



- Frost from the condenser inside the freezer compartment will melt, and may spill water when the refrigerator is transported. It may take 1 day to defrost after unplugging the power plug.

#### **Warning**



**Do not damage the refrigerant circuit, because it contains a combustible refrigerant. If refrigerant leaks, it may accumulate and catch fire or explode.**

## To prevent accidental button operation (Child Safety Lock)

Locks the operation panel to prevent accidental icon operation by children.

- 1 Touch  for about five seconds or more when the door is closed (until the buzzer sounds twice).  
 lights up when the setting is finished.
  - Setting cannot be changed during Child Safety Lock.

### To cancel

- 1 Again, touch  for about five seconds when the door is closed (until the buzzer sounds twice).  
 goes off when the setting is canceled.

## When the mark blinks rapidly (about 5 times per second)



An inspection is required. Contact the retail store where you purchased the refrigerator.

# Other Issues (Continued)







Before Use

## To reset settings

To return each setting to their initial conditions (at the time of purchase), for example if you have forgotten the settings.

- 1 Touch  to light up an icon.
- 2 Touch  for about 10 seconds (until the buzzer sounds twice).

The following settings will be canceled.

- Cool drinks quickly 
- Quick ice making 
- Energy Saving Mode 
- Rapid cool bulk shopping 
- Supercool Freezing 
- Power Save Mode 

- The temperature setting of the versa compartment (freezing and Soft-Freezing) does not change.
- The setting for "stop ice making" will not be canceled.

Placing Food Inside

## When the door alarm sounds and the interior light of the refrigerator compartment blinks

The door alarm sounds when either door is open for 1 minute or longer. When a door is open for 4 minutes or longer, the interior light of the refrigerator compartment blinks.

The number of times the door alarm sounds and the action of the interior light are as follows depending on how long the door has been left open.

Example:  
When the doors of refrigerator compartment and ice making compartment are open

Time for which the door left open	1 minute	2 minutes	3 minutes	4 minutes	5 minutes or longer	60 minutes or longer
Alarm	2 beeps	3 beeps	4 beeps	Continuous long beeps	Continuous short beeps	
Interior light	On			Blinks twice per minute	Off	
Compartment display area	The display for the compartment whose door is open blinks in time with the door alarm sound.					



Compartment display area

- Check that the doors are not left ajar or do not have any food trapped (the packing, the back of the drawer cases). (Check at least once a month.)
- All doors have an opening and closing sensor.
- If the door is kept open for 60 minutes, the interior light turns off.

Operation

## When the alarm cannot be turned off





Press  for about 5 seconds to stop the alarm. Check if the doors are closed. An inspection is required when there is no error state. Contact the retail store where you purchased the refrigerator.

Cleaning

## D When this icon lights up

When **D** lights up, the refrigerator is in demonstration mode. The refrigerator does not cool in this mode. Contact the retail store where you purchased the refrigerator, or cancel the demonstration operation by the following methods.

To cancel the demonstration mode

- 1 Touch  to light up an icon.
- 2 Keep the doors of the versa compartment open.
- 3 Press , , and  at the same time for about five seconds (until the buzzer sounds twice).
- 4 Check that **D** is turned off.
  - The demonstration mode was not canceled if it lights up.

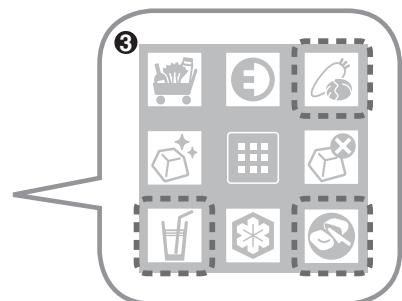

Troubleshooting



## To control the temperature more precisely (temperature fine adjustment mode)

The temperature can be set to 19 different levels for the refrigerator compartment, freezer compartment, or versa compartment (with freezing setting), while it can be set to 5 different levels for versa compartment (Soft-Freezing).

- When temperature fine adjustment mode is set, the compartment display blinks about every 10 seconds.

### Setting the temperature fine adjustment mode

- Touch .
- Touch **SELECT** for about 3 seconds or more (until the buzzer sounds twice).

**To cancel** The same operation as above.

- If the setting is reset, it will be canceled.

### Performing the temperature fine adjustment



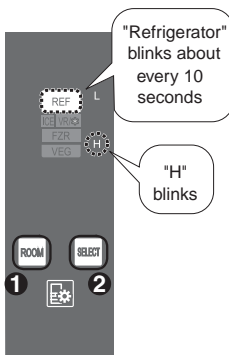

Example: To set the refrigerator compartment lower by 1.2°C than the low setting (when the setting is refrigerator compartment 5)





















- Touch **ROOM** to select the compartment to perform temperature fine adjustment.

- Repeatedly touch **SELECT** to perform temperature fine adjustment.

\* The values on the right are approximate. The temperature may differ from the values on the right, depending on factors such as food storage conditions and how often the doors are opened.  
 represents a blinking display.

Temperature setting	Versa compartment (Soft-Freezing setting)
1 	About -5°C
2 	About -6°C
3 	About -7°C
4 	About -8°C
5 	About -9°C

Temperature setting	Refrigerator/freezer compartments	Versa compartment (Freezing setting)
1 	Low setting ▶ Page 23	About -12°C ▶ Page 23
2 	About 0.3°C lower than "L"	About 2.4°C higher than "M"
3 	About 0.6°C lower than "L"	About 2.1°C higher than "M"
4 	About 0.9°C lower than "L"	About 1.8°C higher than "M"
5 	About 1.2°C lower than "L"	About 1.5°C higher than "M"
6 	Low medium setting ▶ Page 23	About 1.2°C higher than "M"
7 	About 0.9°C higher than "M"	About 0.9°C higher than "M"
8 	About 0.6°C higher than "M"	About 0.6°C higher than "M"
9 	About 0.3°C higher than "M"	About 0.3°C higher than "M"
10 	Medium setting ▶ Page 23	About -15°C ▶ Page 23
11 	About 0.3°C lower than "M"	About 0.3°C lower than "M"
12 	About 0.6°C lower than "M"	About 0.6°C lower than "M"
13 	About 0.9°C lower than "M"	About 0.9°C lower than "M"
14 	Medium high setting ▶ Page 23	About 1.2°C lower than "M"
15 	About 1.2°C higher than "H"	About 1.5°C lower than "M"
16 	About 0.9°C higher than "H"	About 1.8°C lower than "M"
17 	About 0.6°C higher than "H"	About 2.1°C lower than "M"
18 	About 0.3°C higher than "H"	About 2.4°C lower than "M"
19 	High setting ▶ Page 23	About -18°C ▶ Page 23

# Specifications

Before Use

Placing Food Inside

Operation

Cleaning

Troubleshooting

MR-EX655W-N-A and MR-EX562W-N-A are designed for use in Australia and New Zealand only and cannot be used in any other country. No servicing is available outside of Australia and New Zealand.

	Food storage compartment type	Model			
		MR-EX655W		MR-EX562W	
		Gross volume (litres)	Storage volume (litres)	Gross volume (litres)	Storage volume (litres)
Refrigerator compartment	Fresh food	327	296	253	228
Ice making compartment	Short term frozen food	26	5	27	4
Versa compartment	Short term frozen food	55	23	46	17
Freezer compartment	Freezer	131	78	118	59
Vegetable compartment	Special (unfrozen food)	116	72	118	70
	Total volume	655	474	562	378

	Parts	Quantity	
		MR-EX655W	MR-EX562W
Refrigerator compartment	AUTO shelf	1	1
	Two-way flexishelf	2	1
	Slide chilled case	1	1
	Water tank (with optical catalyst and lead-cleaning filter)	1	1
	Adjustable pocket (large)	2	1
	Adjustable pocket (short, large)		1
	Adjustable pocket (small)	2	1
	Adjustable pocket (short, small)		1
	Small item case (upper)	1	1
	Small item case (lower)	1	1
	Egg shelf	1	1
	Bottle pocket (large)	1	1
	Bottle pocket (small)	1	1
Small item holder	2	2	
Ice making compartment	Ice tray	1	1
	Ice storage box	1	1
	Soundproof mat	1	1
	Ice server	1	1
Versa compartment	Versa case	1	1
	Aluminum tray	1	1
Vegetable compartment	Vegetable case	1	1
	Slide case	1	1
Freezer compartment	Freezing case (upper)	1	1
	Freezing case (lower)	1	1
	Adjustable support cover	1	1

# Troubleshooting

First, check the items described in this section. If the problem persists, contact the retail store where you purchased the refrigerator as soon as possible.

■ Frequently asked questions in the initial period and in summer

■ Questions about operation and handling

## The refrigerator does not cool at all!

- The refrigerator takes time to cool when you first start using it. In summer, it may take up to 24 hours for the inside to be fully cooled.
- Has **D** on the operation panel turned on?  
→ Demonstration operation: ► **Page 32**
- Is the power plug disconnected or has the circuit breaker tripped?

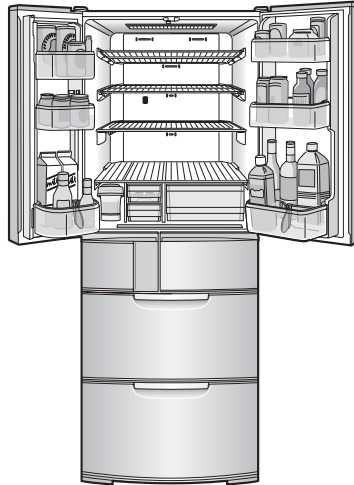

## The operation panel turns off automatically!

- If 30 seconds pass without any operation panel button operations, displays turn off. ► **Page 14**

## The outer walls heat up!

- The outer walls heat up significantly (to about 50 to 60°C) immediately after installation and in summer. This is because the heat discharging and condensation prevention pipes are located on the sides and the top of the refrigerator. They are required for cooling and the heat is not an abnormality.
- The refrigerator compartment rotating partition also has a condensation prevention heater that heats up. ► **Page 6**
- A heat discharging fan is located under the refrigerator. Warm air may be discharged from here.

## Smells the strong odour on the food or ice!

- Do you clean the water tank and the water supply pump once a week?  
► **Pages 26 - 27**
- Have you placed food with strong odour inside the refrigerator without sealing in a container? ► **Page 9**

## Cooling performance

Problem	Check	Explanation and action
<b>Food freezes in the refrigerator and vegetable compartments</b>	1 Is the temperature on the operation panel set to "H"?	Set the temperature to "M". The temperature drops temporarily depending on the setting. ► <b>Pages 22 - 23</b>
	2 Is food with a lot of moisture stored at the rear of the shelf?	Place drinks and food containing a lot of water, such as tofu, vegetables and fruit, at the front.
	3 Is the surrounding temperature 5°C or less?	Freezing is likely to be prevented when the temperature settings of the refrigerator compartment and vegetable compartment are set to "L". ► <b>Pages 22 - 23</b>
	4 Is the water supply pipe installed correctly?	When the installation is incorrect or a gap is caused by a foreign object, the cold air may flow in reverse and cause food in the refrigerator compartment to freeze.
<b>Food in the versa compartment melts</b>	1 Has enough time passed after temperature adjustment or installation?	The refrigerator takes time to cool completely. Wait at least 30 minutes before placing food inside.
	2 Is food stuck up in the upper area?	Leave a gap in the upper area so that the cold air can flow.
	3 Did the hot food make contact with other foods?	Frozen food may thaw if it makes contact with hot food.
	4 Did you set the supercool freezing after placing hot food inside?	set the supercool freezing after placing hot food inside. The food temperature will drop quickly.
	5 Was ice cream or frozen food stored with the "FZR" "L" or "FZR" "M" setting?	Set to "FZR" "H". ► <b>Pages 22 - 23</b>
	6 Is the versa compartment set to Power Save Mode?	Cancel Power Save Mode. ► <b>Page 24</b>
<b>Does not cool well</b> <b>Not much ice is made</b> <b>Ice melts</b>	1 Is "L" set as the temperature for the compartment?	Set the temperature to "M" or "H". ► <b>Pages 22 - 23</b>
	2 Has enough time passed after installation?	It takes 4 to 5 hours for the refrigerator to cool, and 24 hours or more in summer to fully cool.
	3 Is heat discharging being blocked? Check if there is gap around the refrigerator and the refrigerator is not exposed to direct sunlight.	Check that the refrigerator is installed correctly. ► <b>Page 6</b>
	4 Is the flow of cold air being blocked? Are the doors being opened frequently, or left ajar?	Check the quantity of food inside and ajar door.
	5 Is the ice making compartment or versa compartment set to Power Save Mode?	Cancel Power Save Mode. ► <b>Page 24</b>

Before Use

Placing Food Inside

Operation

Cleaning

Troubleshooting

# Troubleshooting (Continued)



Before Use

Placing Food Inside

Operation

Cleaning

Troubleshooting

	Problem	Check	Explanation and action
Ice making	Cannot make ice Water in the tank stays at the same level	❶ Has enough time passed after installation?	It takes 4 to 5 hours after first starting operation for the refrigerator to cool, and 24 hours or more in summer to make ice.
		❷ Is the ice tray installed correctly?	Set the ice tray lock lever to the correct position and check the installation status of the ice tray. ▶ Page 26
		❸ Are the water supply pump and tank pipe installed correctly onto the water tank?	Install them correctly onto the water tank. (In particular, ensure that the opening of the tank pipe inside the tank is installed firmly to the tank.) ▶ Page 27
		❹ Is the water supply pipe installed correctly in the tank holder area?	When the installation is incorrect or a gap is caused by a foreign object, the cold air may flow in reverse and prevent ice from forming. ▶ Page 26
		❺ Has food, the ice server, or other object been left in the ice storage box?	The ice storage box is judged to be full of ice. Remove food or other objects from the ice storage box. Also, spread the ice out flat all the way to the front.
		❻ Is the ice making setting for the ice making compartment set to "STOP"?	Cancel the "STOP" ice making mode. ▶ Page 17
		❼ Is the ice making compartment set to Power Save Mode?	Cancel Power Save Mode and then set the ice making compartment to "REG" or "QCK". ▶ Page 24
		❽ Is there enough water in the water tank? Is the refrigerator tilted?	The number of ice cubes in one batch may be reduced. Pour water into the water tank. ▶ Page 13
Ice is small or joined together	❶ Has ice been stored inside the ice storage box for a long time?	If the ice is stored inside the ice storage box for a long time, ice cubes may join together or shrink (due to a phenomenon called sublimation).	
	❷ Is the ice making compartment set to Power Save Mode?	Cancel Power Save Mode. ▶ Page 24	
Supercool freezing	Supercool frozen food does not taste good	❶ Did you set the Supercool Freezing?	Set the Supercool Freezing. ▶ Page 19
		❷ Is the food that you want to supercool freeze placed in the top of the versa compartment, and not being overlapped by other food?	The food temperature is measured with the infrared sensor. Lay out the food for supercool freezing flat and on top in the versa compartment. ▶ Page 21
		❸ Has enough time passed after changing the versa compartment to "Soft-Freezing"?	Set to Soft-Freezing, and when the temperature has stabilized (after about 2 hours), perform supercool freezing. ▶ Page 19
Door and operation panel	Doors open easily Doors do not close	❶ Is a door making contact with food or a case? Is too much food packed inside?	Store food so that the door does not make contact with objects when closed.
		❷ Has food fallen behind a case in a drawer door, or is the power cord or another object trapped between the refrigerator and a door?	Remove any objects. Make sure that the door does not trap objects such as food, power cords or plastic bags.
		❸ Is the refrigerator installed stably? Are the adjustable supports making contact with the floor?	Lower the adjustable supports to raise the front side slightly and make the doors easier to close. ▶ Page 7
	Door alarm sounds Interior light turns off Compartment display on the operation panel blinks	❶ Are any of the doors open?	Close the door. The alarm sounds at every minute after the door is opened, and after 4 minutes it sounds continuously. ▶ Page 32 If the alarm sounds even after closing the door, press the  button for 5 seconds or more to stop it. An inspection is required. Contact the retail store where you purchased the refrigerator.
		❷ Is the rotating partition of the refrigerator compartment open to the front?	Check the position of the rotating partition while the doors are open.
The operation panel does not respond	❶ Is  lit?	Cancel the Child Safety Lock. ▶ Page 31	
	❷ Are the user's fingers or the operation panel wet or dirty?	Wipe off the moisture and dirt on the operation panel and fingers.	
	❸ Are you wearing a band-aid on your finger or gloves during operation?	Touch the operation panel with your finger directly.	

	Problem	Check	Explanation and action	
Door and operation panel	The operation panel does not respond (continued)	4 Are you trying to operate the operation panel with the tip of your fingernail or a sharp object?	Touch the operation panel with your finger directly.	
		5 Are you touching out of position?	Touch the centre of the icon.	
		6 Are seals and tapes put on the operation panel?	Remove the seals and tapes.	
	Reacts without a touch	1 Are there any towels, plastic bags, papers, etc. over the operation panel?	Remove the towel, plastic bag, paper, etc.	
Some icons do not light up	1 Is the compartment set to Power Save Mode?	The icons that cannot be set during Power Save Mode are off. <b>► Page 25</b>		
Sound	Loud noises Annoying noise (These noises are normal)	1 The noise gets louder suddenly or the tone changes.	Immediately after installation, when the weather is hot, when the doors are frequently opened and closed, during the operation of Rapid cool bulk shopping, and in similar situations, the refrigerator switches to high-speed operation and cools with high power.	
		2 A rattling or squeaking sound is made sometimes (every 1 to 2 hours).	This is the sound of the automatic ice maker. Even when there is no water in the water tank, the automatic ice maker and pump make a sound about every 100 minutes.	
		3 After turning on the power, a thumping or creaking sound may be heard in the ice making "STOP" mode (every 1 to 2 hours).	This is the sound of the automatic ice maker's operation check. The check is performed even in the "STOP" ice making mode.	
		4 A whistling sound is made after closing a door.	This is the sound of the fan motor starting.	
		5 A hissing, bubbling, or running water sound is made sometimes.	This is the sound of the refrigerant (gas) flowing.	
		6 A whipping or dripping sound is sometimes heard from inside the refrigerator after a door is opened.	This is the creaking sound as warm air enters and expands the plastic.	
		7 A buzzing sound is made sometimes.	This is the operating sound of the damper as it adjusts the air flow.	
		8 A low whirring sound is made after opening the freezer compartment door.	This is the sound of air blowing through the cooling fan.	
Others	Condensation forms on the outer walls and inside the refrigerator	1 Are the doors being opened frequently, or left ajar?	When moisture in the air cools, it forms frost or condensation. Even when a door is open only slightly, it can cause frost or condensation, or dripping onto the floor.	
	Frost forms in the freezer compartment	2 Is the humidity high, for example is it raining?	Condensation may form temporarily. Wipe off with a dry cloth. Condensation may cause frost to form in Freezer compartment, please minimise the time that doors are kept open.	
	Water drips onto the floor			
	Frost and condensation forms in the vegetable compartment		Depending on the amount and type of vegetables, the moisture from the vegetables may cause frost or condensation on the roof or the surface of the cases. When condensation forms, wipe it off with a dry cloth. If you care that, store vegetables in plastic wrap.	
	Water tank or water supply pipe freezes	1 Are the water supply pipe and tank pipe installed firmly in the water tank? Is there a foreign object between the water tank and the water supply pipe?		When the installation is incorrect or a gap is caused by a foreign object, the cold air may flow in reverse and cause freezing. <b>► Page 26</b>
		2 Has food, a plastic bag, or another object fallen behind the case in the ice making compartment or freezer compartment?		The cold air may flow in reverse and cause freezing. Remove any objects.
Water tank or water supply pipe is warm		This is because of the anti-freeze heater. It is not an abnormality.		
Noise interferes with televisions or other devices	1 Is the refrigerator installed near to an electronic device such as a television?		Install the refrigerator away from electronic devices such as televisions.	
	2 Is the power to the refrigerator supplied from a socket near the entry hole of the antenna cable?		We recommend using a separate power supply. When there is no grounded terminal on the plug, connect the grounding wire.	

# Memo

# Memo

- This refrigerator uses flammable foaming gas for insulation.  
Please deliver the unit to specialized industrial waste dealer when you do away it.  
Please follow the rules in your country.
- **WARNING** - Do not use mechanical devices or other means to accelerate the defrosting process, other than those recommended by the manufacturer.
- **WARNING** - Do not use electrical appliances inside the food storage compartments of the appliance, unless they are of the type recommended by the manufacturer.
- **WARNING** - Just in case of having damaged the refrigerant circuit, do not use electric items or fire equipments near by, and open the window to ventilate the room. And contact the retail store at which you purchased it or the following MITSUBISHI ELECTRIC SERVICE CENTRE.
- The refrigerator contains flammable refrigerant (R600a: iso-butane).
- The refrigeration system behind and inside the refrigerator contains refrigerant.  
Do not allow any sharp objects to come into contact with the refrigeration system.
- Do not block the openings on the circumstances of the refrigerator.
- The user manual should be handed over to any person who would use or handle the refrigerator whenever the refrigerator would be transferred to another location and delivered to a recycling plant.
- The appliance is not intended for use by young children or infirm persons without supervision.
- Young children should be supervised to ensure that they do not play with the appliance.

### **R600a Refrigerant Warning**

- This appliance contains a small quantity of R600a refrigerant which is flammable.
- During transportation and installation, ensure that the tubing of the refrigerant circuit is not damaged.
- Leaking refrigerant can ignite and may damage the eyes.
- In the event any damage does occur, avoid exposure to open fires and any device which creates a spark.  
Disconnect the appliance from the mains power.
- Thoroughly ventilate the room in which the appliance is located for several minutes.
- Notify Mitsubishi Electric Australia Pty Ltd. for necessary action and advice.
- The room for installing the appliance must be at least 1 cubic metre per 8 grams of refrigerant.  
The refrigerant quantity contained in this appliance is noted on the Rating Plate of the appliance.
- If your Mitsubishi Electric Refrigerator should require service, please contact Mitsubishi Electric Australia Pty Ltd see back page of this user manual for contact details.

**NOTE: MITSUBISHI ELECTRIC AUSTRALIA PTY LTD. DO NOT ALLOW SERVICE TO THE REFRIGERATION CIRCUIT OF THIS APPLIANCE.**

#### **SOLE AGENT in Australia**

#### **MITSUBISHI ELECTRIC AUSTRALIA PTY LTD.**

(Incorporated in New South Wales) ABN 58 001 215 792

#### **New South Wales:**

348 Victoria Road, Rydalmere NSW 2116 Ph: (02) 9684 7777, Fax: (02) 9898 0484

#### **Queensland:**

Da Vinci Business Park, Building 101, 2A Boronia Road, Brisbane Airport QLD 4008

Ph: (07) 3623 2000, Fax: (07) 3860 6761

#### **South Australia / Northern Territory:**

Suite 1, 224 Glen Osmond Road, FULLARTON SA 5063 Ph: (08) 8338 1001, Fax: (08) 8338 0501

#### **Western Australia:**

Unit 5, 329 Collier Road, Bassendean WA 6054 Ph: (08) 9377 3400, Fax: (08) 9377 3499

#### **Victoria / Tasmania:**

Suite 2, 10 Compark Circuit, Mulgrave VIC 3170 Ph: (03) 9535 7800, Fax: (03) 9535 7801

#### **SOLE AGENT in New Zealand**

#### **BLACK DIAMOND TECHNOLOGIES LIMITED (BDT)**

#### **Wellington Office (Head Office)**

1 Parliament Street, Lower Hutt, PO Box 30772, Lower Hutt 5040 Ph: (04) 560 9147, Fax: (04) 560 9133

#### **Auckland Office**

Unit 1, 4 Walls Road, Penrose, PO Box 12726, Penrose, Auckland 1061 Ph: (09) 526 9347, Fax: (09) 526 9348

#### **Christchurch Office**

44 Halwyn Drive, Hornby, PO Box 16904, Hornby, Christchurch 8441 Ph: (03) 341 2837, Fax: (03) 341 2838

**MITSUBISHI ELECTRIC CORPORATION**