



Refrigerator-Freezer

MODEL

**MR-E62S**

OPERATING INSTRUCTIONS



**R600a**

# Function Overview

Move and rotate for efficient use of space from the top to bottom shelves



## Revolving Shelf

Get the hard-to-reach items at the top, innermost position!



Refrigerator compartment

Shelves can be rotated without removing food.

► Pages 20 - 21

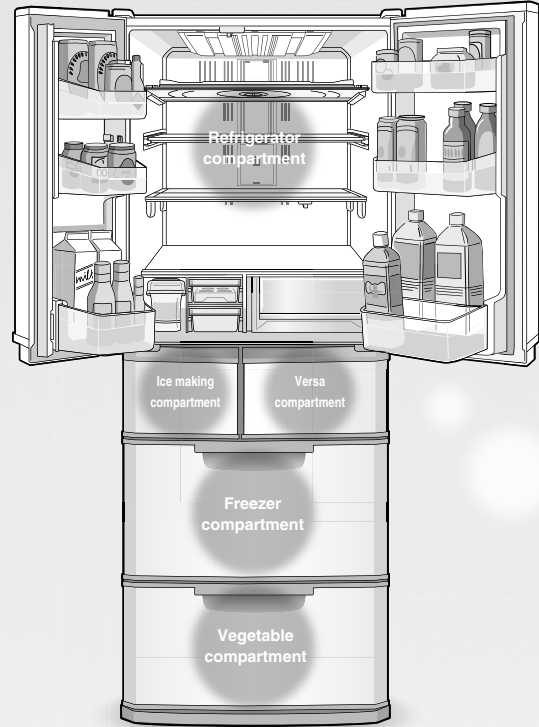

You can place freshly cooked, hot food directly inside!

The food temperature is stabilized to minimize frost and discoloration. (Freezer burn control)



Versa compartment

After supercool freezing, store in the soft freezing mode.



### Soft Freezing

Frozen but you can cut!

► Pages 14 - 17

**HIKARI Supercool Freezing**

► Pages 15 - 17

The cold air is sterilized<sup>\*1</sup> and deodorized with the HIKARI LED and filter.



Refrigerator compartment

**HIKARI Active Vio deodorizer<sup>\*1</sup>**

► Pages 20 - 21

<sup>\*1</sup> The effect has been proven after 18 with a 12 cm<sup>2</sup> filter, but these conditions

### Silent Design

An extremely low noise level of about 16 dB(A)<sup>\*2</sup>.

<sup>\*2</sup> According to the noise level test specified in JIS C9607 (at low speed operation). dB(A): Noise level unit. Decibel A

- This refrigerator is manufactured for refrigerating and freezing foods in general households. For industrial use, please use a commercial
- The material names are indicated on the main plastic parts to facilitate recycling.

# Contents

Page

Safety Precautions	4-5
From Installation to Operation	6-7
Placing Food Inside	8-9
Using the Control Panel	10-11
Compartment Temperature Control	12
Selecting the Ice Making Mode	13
Versa Compartment Temperature Control	14
Freezing for Delicious Food (Supercool Freezing)	15
Tips for Supercool Freezing and Soft Freezing	16-17
Power Saving (ECO MODE, ECO GUIDE)	18
Other Settings (Child Safety Lock, Setting Reset)	19
Refrigerator Compartment	20-21
Freezer Compartment Versa Compartment (Supercool Freezing Room)	22-23
Vegetable Compartment	23
Ice Making Compartment (Automatic Ice Maker)	24-25
Cleaning the Automatic Ice Maker	26-27
Removing and Cleaning the Parts	28-29
Other Issues	30-31
Specifications	31
Troubleshooting	32-34

Before Use

Operation

Cleaning

Troubleshooting

## ↑ ↓ AUTO Shelf

When you only need a little more height... no problem!

Shelves can be moved up and down without removing food.



Refrigerator compartment

▶ Page 21

The vitamins in vegetables are boosted by the HIKARI LED

Delicious, crystal clear ice is made using the HIKARI LED and filter



Vegetable compartment

HIKARI Vitamin Factory



Ice making compartment

HIKARI UV Crystal Ice

▶ Page 23

▶ Page 24

hours in a test where bacteria was sterilized in a sealed container vary from the actual operation conditions.

refrigerator-freezer.

# Safety Precautions

The danger and degree of danger caused by improper handling are categorized and described with the following indicators.

## Warning

Improper handling can result in death or serious injury.

## Caution

Improper handling can result in personal injury or damage to your house, household furnishings, etc.

■ Meaning of symbols.



Never do



Never touch



Never attempt to disassemble, repair or alter



Never expose to water



Never touch with wet hands



Be sure to follow the instructions



Be sure to remove the power plug from the socket



If an abnormality or malfunction occurs, stop operation immediately and contact the retail store where you purchased the refrigerator or a Mitsubishi Electric Maintenance Service or Customer Service representative.

## Installation

### Leave space around the refrigerator.

If refrigerant leaks, it may accumulate and catch fire or explode.

▶ Page 6



Leave space



### Anchor the refrigerator to a strong wall or post to protect against damage during earthquakes.

The refrigerator may tip over and cause injury.

▶ Pages 6 - 7



Prevent tipping



### Do not install the refrigerator outdoors or in places exposed to water or excessive humidity.

Water may cause insulation failure, resulting in an electric shock or fire.

▶ Page 6



Water prohibited



### Use a dedicated outlet for the power supply that meets the rating specified on the rating label. (The rating label is located on the door-liner of the refrigerator compartment.)

Using extension cords and plugging too many leads into a single socket can cause heat build-up or fire.

▶ Page 6

Only use an outlet that meets the specified rating.



### If the power cord is damaged, call our MITSUBISHI SERVICE CENTER for the replacement.

If the power cord is damaged, purchase a new cord from MITSUBISHI SERVICE CENTER. Make sure that the power cord is designed for this model.

▶ Page 6



Service Call

### Insert the power plug with the cord facing down, and fully insert the prongs.

Inserting the plug upside-down places stress on the cord and may cause heat generation or fire.



Cord facing down



## Power and power plug

### Remove the power plug before cleaning.

Otherwise an electric shock or injury may result.



Remove plug



### Do not crush the power plug with the rear of the refrigerator. Do not damage the power cord.

Pressing, folding, bundling or placing heavy objects on the power cord may cause an electric shock or fire.



Prohibited

### Do not use damaged cords or plugs, or loose sockets.

Doing so may cause an electric shock or fire.



Do not use



### Do not pull the cord when unplugging the power plug.

The cord may be damaged, resulting in electric shock or fire.



Prohibited

### Remove dust periodically from the power plug.

Dust may cause insulation failure, resulting in fire.



Remove dust



### Do not plug in or out the power plug with wet hands.

Doing so may cause an electric shock.



Wet hands prohibited

## Installation and transportation

### Anchor the refrigerator to a strong and level floor by adjusting the adjustable supports.

Otherwise, the refrigerator may move and cause injury.

▶ Pages 6 - 7

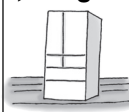

Install level



### Use the transportation hand-holds when transporting the refrigerator.

Holding other parts may result in injury.

▶ Page 30



Use the hand-holds



### Be careful not to damage the floor or injure yourself when moving the refrigerator.

Lay a protective sheet on the floor and move the refrigerator slowly.



Use protective material



















### Do not pack in excessive amounts of food. Do not pull the shelves with excessive force. Food may fall out and cause injury.





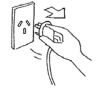

Prohibited

# Warning

Operation		
<p><b>Do not place water containers on top of the refrigerator.</b> Exposing electrical parts to water may cause an electric shock or fire.</p>  <p>Water prohibited</p>	<p><b>Do not use electrical appliances inside the refrigerator.</b> The refrigerant gas leaking into the compartment with sparks from an electrical contact may cause fire and explosion.</p>  <p>Prohibited</p>	<p><b>Do not place volatile, inflammable objects inside the refrigerator.</b> Benzene, cosmetics and hair dressing products may catch fire or explode.</p>  <p>Do not store</p>
<p><b>Do not place objects on top of the refrigerator.</b> Objects may fall when the doors are opened or closed and cause injury.</p>  <p>Prohibited</p>	<p><b>Do not store chemicals or scientific specimens in the refrigerator.</b> Substances that require strict control must not be stored in household refrigerators.</p>  <p>Do not store</p>	<p><b>Do not hang from the door or handle. Do not climb on an open door. Do not apply a heavy load.</b> The refrigerator may tip over and cause injury.</p>  <p>Prohibited</p>
<p><b>Do not touch the mechanical area of the automatic ice maker (area above the ice tray).</b> Doing so may result in injury.</p>  <p>Do not touch</p>	<p><b>Do not damage or drive screws into the refrigerator's refrigerant circuit (pipes).</b> Because combustible refrigerant is used, this may result in fire or an explosion.</p>  <p>Prohibited</p>	<p><b>If you notice a gas leak, do not touch the refrigerator. Open windows to ventilate.</b> Sparks from an electrical contact may cause an explosion or fire.</p>  <p>Ventilate</p>
<p><b>Do not wash with water or spill soup or juice onto the refrigerator.</b> Water or other liquid may cause an electric shock or fire. Wipe off any liquid immediately.</p>  <p>Water prohibited</p>	<p><b>Do not use combustible sprays near the refrigerator.</b> Sparks from an electrical contact may cause an ignition and fire.</p>  <p>Do not use</p>	<p><b>Do not use in a shed or garage.</b> Pet animals may damage the electrical wiring and cause an electric shock or fire.</p>  <p>Do not use</p>

Malfunctions and long-term storage		
<p><b>If the refrigerant circuit (pipe) is damaged, do not touch the refrigerator and avoid using flames. Open windows to ventilate.</b> If the refrigerant circuit is damaged, contact the retail store.</p>  <p>Ventilate</p>	<p><b>If an abnormality occurs (such as a burning odor), unplug the power plug and stop the refrigerator operation.</b> Continuing to operate with an abnormality may cause an electric shock or fire.</p>  <p>Remove plug</p>	<p><b>Do not disassemble, repair or alter. Do not use while parts are damaged.</b> Doing so may cause injury, electric shock or fire.</p>  <p>Do not disassemble</p>
<p><b>If there is a possibility of a child getting trapped in the refrigerator during storage, pull out and remove the door packing.</b> Children getting trapped in refrigerators is very dangerous.</p>  <p>Remove packing</p>	<p><b>When not using the refrigerator for a long time, unplug the power plug and open the doors to dry the refrigerator.</b> If the refrigerator is not dried sufficiently, refrigerant may leak due to condenser corrosion and cause a fire or explosion.</p>  <p>Dry</p>	<p><b>Contact the retail store or municipal government for details about correct refrigerator disposal.</b> Improper disposal may cause refrigerant leaks, resulting in a fire or explosion if exposed to a flame.</p>  <p>Dispose properly</p>

# Caution

Operation		
<p><b>Do not touch food or containers in the freezer compartment with wet hands.</b> Doing so may cause a cold injury.</p>  <p>Wet hands prohibited</p>	<p><b>Do not place glass bottles in the freezer, ice making and versa compartments.</b> The bottle may break if the liquid inside freezes, causing an injury.</p>  <p>Do not store</p>	<p><b>Do not put your hands or feet under the refrigerator.</b> The steel plates or other parts may cause injury.</p>  <p>Do not touch</p>
<p><b>Do not eat food that is discolored or has a bad odor.</b> Doing so may result in food poisoning or illness.</p>  <p>Prohibited</p>	<p><b>Observe the following when opening and closing the doors.</b></p> <ul style="list-style-type: none"> <li>• Do not open or close the doors when another person is touching the refrigerator.</li> <li>• Do not put your fingers on the top edge of a drawer-type door while closing it.</li> <li>• Do not open or close the doors with excessive force. (Food may fall out and cause injury.)</li> <li>• Be careful not to trap your fingers or any other part of your body.</li> <li>• Be careful not hit a part of your body.</li> <li>• Do not trap your feet with the bottom drawer. (Danger of your toes caught by the drawer.)</li> </ul>  <p>Prohibited</p>	

Before Use

Operation

Cleaning

Troubleshooting

# From Installation to Operation

Before Use

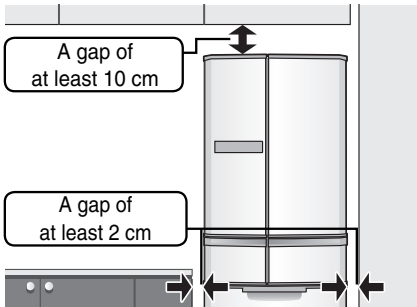

Dedicated outlet that meets the specified rating.

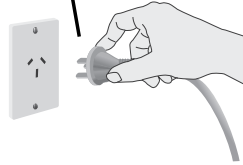

**Turn on the power of the refrigerator as soon as possible.**  
The refrigerator will not be damaged even if you turn on the power immediately after the installation.

## 1 Installation

### Install the refrigerator in:

- **A place with good ventilation not exposed to direct sunlight or hot air**  
To prevent a drop in cooling performance and to reduce power costs.
- **A place with low humidity**  
To prevent rusting, electric shock and fire.
- **A strong and level place**  
To prevent vibration and noise, and ajar or tilting doors.  
If the refrigerator supports sink easily into the floor material, lay a strong plate or board underneath.  
(To prevent deformation or discoloration due to the weight or heat.)
- **A place away from other devices**  
To prevent noise or video interference with devices such as televisions.
- **A place with at least 2 cm of space on the left and right of the refrigerator, and 10 cm of space from the top.**  
To allow heat to dissipate from the top and the sides of the refrigerator.

#### **Warning**

**Do not obstruct the refrigerator vents or the space around the refrigerator. If refrigerant leaks, it may accumulate and catch fire or explode.**

## 2 Connect the power supply

\*Connect power supply soon after installing the refrigerator

### ● Use a dedicated outlet

Use a dedicated outlet for the power supply that meets the rating specified on the rating label. (The rating label is located on the door-liner of the refrigerator compartment.)

#### **Warning**

**Using outlets that do not meet the specified rating or plugging in too many leads into a single socket can cause heat buildup or fire.**

- **The refrigerator will not be damaged even if the power is supplied soon after installation. It takes a while for the refrigerator to cool, therefore supply power as soon as possible.**

### ● Electrical Connections

**Make sure this unit is properly grounded.**

- The refrigerator should always be plugged into its dedicated electrical outlet.  
This will provide the best performance and prevent electrical circuits from being overloaded and causing a fire.  
Make sure that the electrical outlet provides the proper voltage.  
Extension cords are not recommended.
- If your refrigerator is installed in the high humidity location, not only ground connection but also installation of the earth leakage breaker is recommended.
- If the power cord is damaged, purchase a new cord from MITSUBISHI SERVICE CENTER. Make sure that the power cord is designed for this model.
- If the power cord is damaged, call our MITSUBISHI SERVICE CENTER for the replacement, in order to avoid a hazard.

Operation

Cleaning

Troubleshooting

### The outside of the refrigerator and the rotating partition get hot.

Heat dissipation causes the temperature to rise to about 50°C to 60°C when operation is first started, and during the summer. The rotating partition may get hot when heated by the heater.

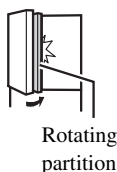

### Cooling takes time after turning on the refrigerator.

- Wait until the refrigerator has fully cooled before storing non-cooled food or ice cream.
- Do not open the doors more than necessary, and close them as soon as possible.

**When making ice for the first time**

In the summer, it may take more than 24 hours.

### Bottom front of refrigerator

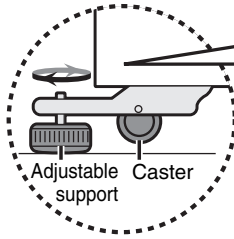
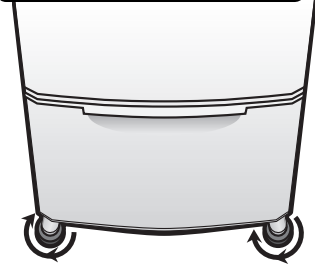

Turn the adjustable supports in the arrow direction until they touch the floor.

**Caution**  
If the supports are not adjusted properly, the refrigerator may move and cause injury.

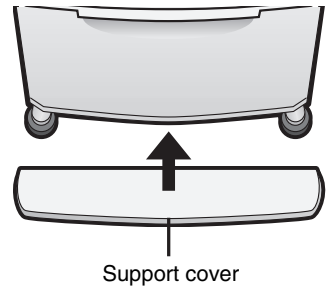

Support cover

## 3 Adjustment and anchoring

(To prevent vibration, noise, movement, and ajar doors)

Turn the adjustable supports until they touch the floor and the front casters are raised from the floor.

- Preventing ajar doors
- Adjusting a tilted door or unevenness

Adjust the supports to make the refrigerator level.

If the front of the refrigerator is slightly raised, the doors are easier to close.

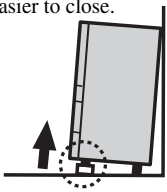

Readjust the adjustable supports as shown in the figures below.

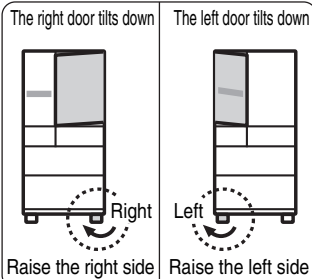

If the installation location is not level or the supports sink after a few days due to the weight of the food, the doors may appear tilted. Readjust the supports. (Depending on the volume stored, more than 100 kg of food can be stored in the refrigerator.)

- If the door is still tilted after adjustment of the supports

When installing the refrigerator in the corner of a room, one of the rear supports may sink, causing the refrigerator to tilt. If this happens, use a caster support (sold separately) or strong board for adjustment. (Normally, use a board with a thickness of about 2 to 3 mm.)

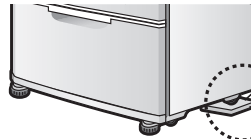

Rear support  
Caster support or strong board

To purchase a caster support, contact the retail store where you purchased the refrigerator.  
Model: MRPR-03CS

## 4 Support cover

The support cover is stored inside the refrigerator compartment at shipment.

- Installing the support cover

Insert the support cover horizontally and fully, until it makes contact with the rear side.

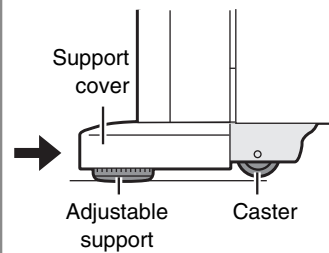

### Do not damage or drive screws into the refrigerant circuit (pipes).

Although flammable refrigerant is used, the refrigerant circuit is hermetically sealed and normally leaks will not occur.

#### Warning

Should the refrigerant circuit be damaged:

1. Do not use flames or electrical appliances nearby.
2. Open the windows to fully ventilate the room.

Then, contact the retail store where you purchased the refrigerator.

### Prepare for earthquakes.

Pass 2 strong belts through the hand-holds on the top rear of the refrigerator and anchor them to a strong location, such as wall or post. To obtain the refrigerator tipping prevention belts (sold separately), contact the retail store where you purchased the refrigerator.

Model: MRPR-02BL

Strong belts

#### Warning

The refrigerator may tip over and cause injury.

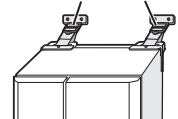

# Placing Food Inside

You are now a skillful storage organizer 🎵  
Get the most out of your refrigerator to make cooking more fun! and dishes tastier!

Before Use

Operation

Cleaning

Troubleshooting

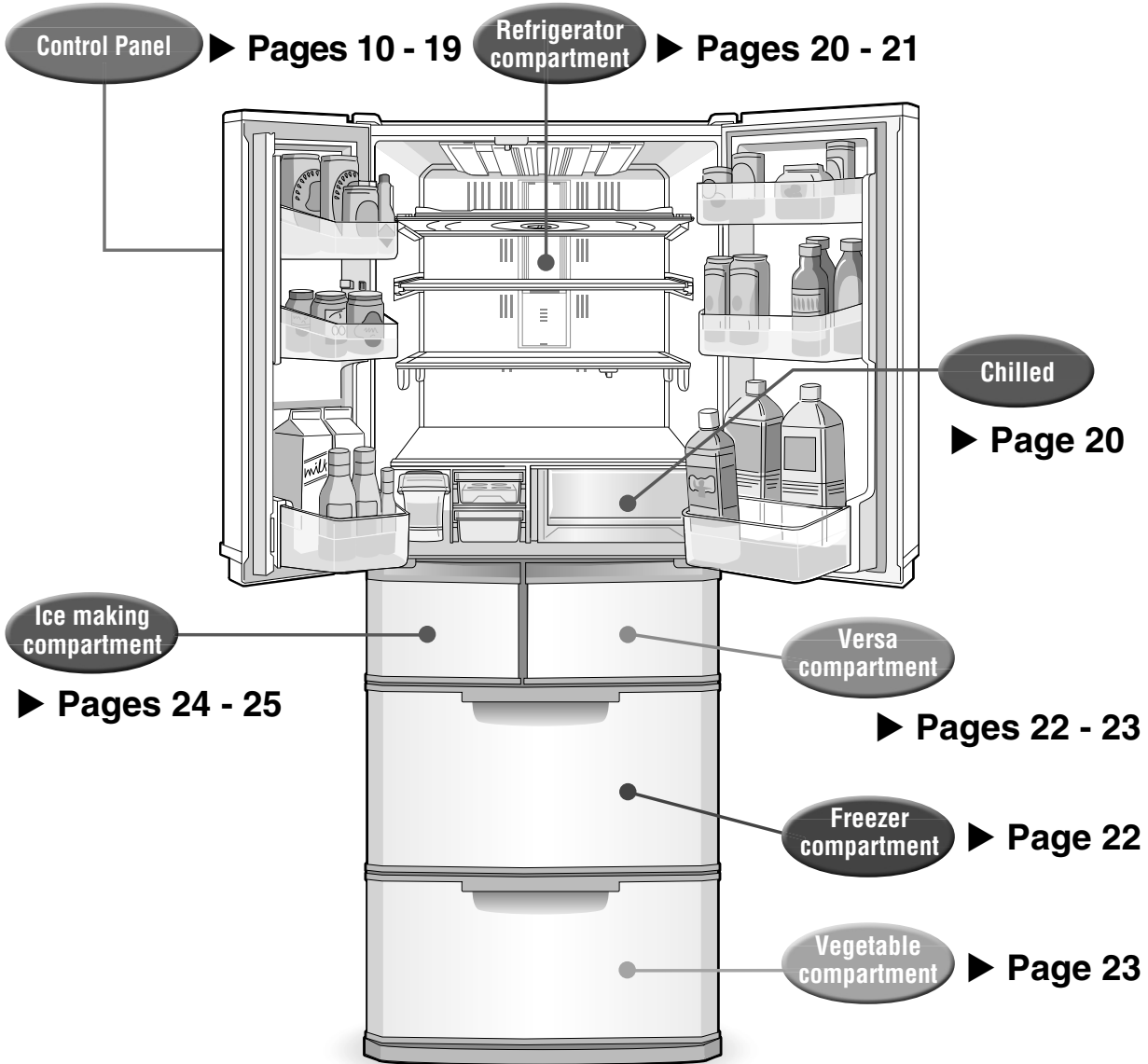

## Note

- The temperatures described here are measured in the lower center of the refrigerator after the temperature has stabilized when the surrounding temperature is 30°C and the doors are closed without any food inside. The temperature fluctuates with factors such as the food storage condition and how often the doors are opened and closed.



### Refrigerator compartment

About **0°C to 6°C**

#### Food to be used soon

- Food or ingredients that are used daily
- Keep eggs in the chilled egg compartment
- Food you do not want to freeze

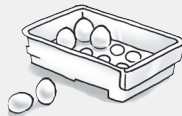

### Chilled

About **-3°C to 3°C**

- Dairy products: Yoghurt, cheese, etc.
- Paste-like products: Minced fish, fish rolls, etc.
- Processed food: Ham, sausages, etc.
- Fresh food: Meat, fish, shellfish, etc.



### Versa compartment

Soft freezing: About **-9°C to -5°C** (Can be changed to freezing)

#### Food you want to supercool freeze

Freeze without losing moisture and taste.

- Rice
- Curry
- Sauces



For details ▶ Pages 16 - 17

#### Soft freezing makes storage more convenient

Preparation is easy even while frozen.

- Blocks of meat
- Ground meat
- Cutlets, cod roe

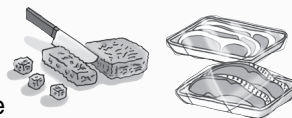

For details ▶ Pages 14, 16 - 17

### Freezer compartment

About **-22°C to -16°C**

#### Food for long-term storage

- Frozen food
- Ice cream
- Food frozen at home



#### Note

- Do not stack food higher than the case. (The food will be caught at the rear of the case and may keep the door ajar.)

### Vegetable compartment

About **3°C to 9°C**

#### Vegetables and fruit

- Vegetables
- Fruit
- Drinks (2 L plastic bottles can fit in the front bottle pocket.)



#### Note

Storing fruit and vegetables in plastic wrap keeps them even fresher.



- The water that evaporates from the food is kept inside the compartment to maintain the moisture. Depending on the storage condition of vegetables or other food, using plastic wrap can keep them even fresher.

# Using the Control Panel

## ECO MODE

Use when you want to save power. When the temperature inside the refrigerator is stable, the power-saving operation is performed automatically. (Operates with the freezer compartment temperature set slightly higher.) ▶ **Page 18**

## ECO GUIDE

The "ECO Level" of the refrigerator is indicated by the number of leaves. The higher the number of leaves, the better the power-saving performance. ▶ **Page 18**

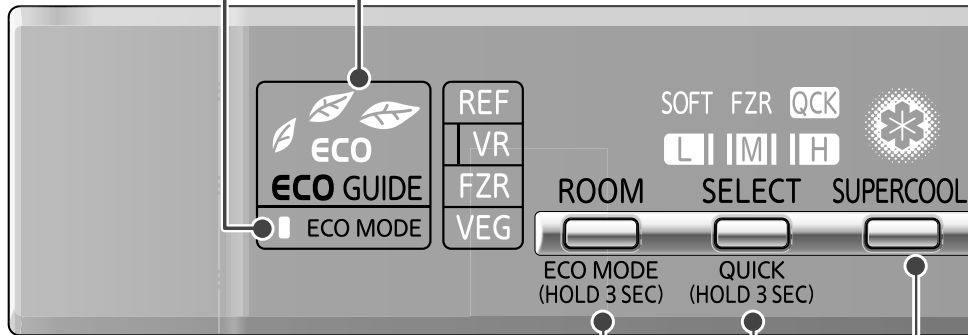

\* This display example may differ from the actual display.

## Switches the displayed compartment

The screen display changes each time the button is pressed.

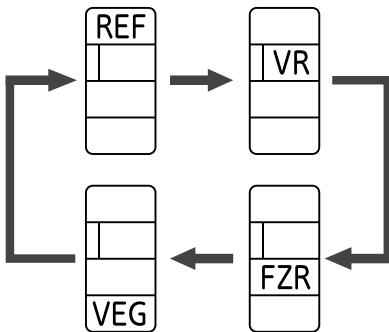

## Sets the temperature of the displayed compartment

- Refrigerator, freezer, and vegetable compartments ▶ **Page 12**
- Fast cooling (QCK) ▶ **Page 12**
- Versa compartment ▶ **Page 14**

## Initial settings (at time of purchase)

Refrigerator, freezer, and vegetable compartments: ... "M"  
Ice making compartment: ... "REG"  
Versa compartment: ..... "SOFT FZR" • "M"

### Note

- When a control panel button is pressed, the display lights up. Note that the corresponding operation is not performed yet. Press the button that you want to operate after lighting up the display.
- After a (refrigerator, freezer or ice making compartment) door is closed, the ECO GUIDE and ECO MODE displays light up for about 30 seconds.
- To return the compartment selection, temperature control, fast cooling and supercool freezing settings to their initial condition (at the time of purchase), for example if you have forgotten the settings ▶ **Page 19**

To save power, the control panel display turns off if there is no operation for about 30 seconds. (The settings are saved.)

To check the setting (or operation) status, press a control panel button to light up the display.

Before Use

Operation

Cleaning

Troubleshooting

## Child safety lock

Locks the control panel to prevent accidental button operations by children. **▶ Page 19**

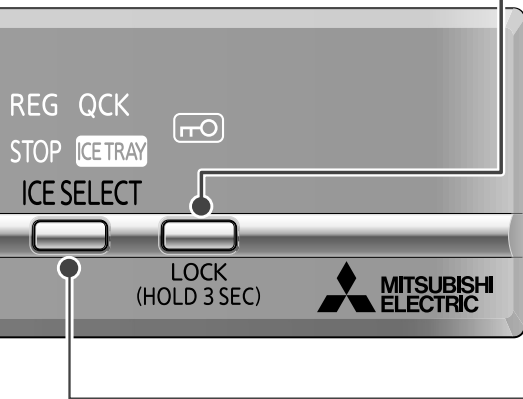

## Display example

(Example: When the versa compartment is displayed)

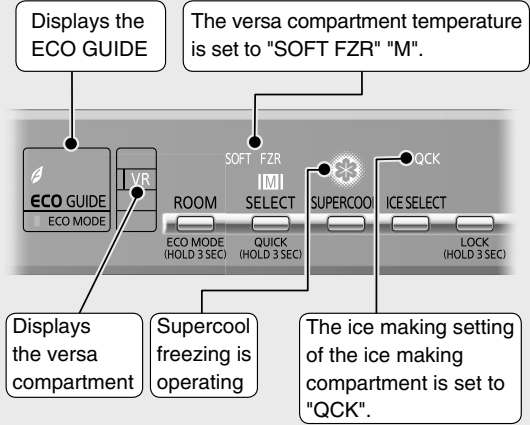

## Supercool freezing

Press to start supercool freezing. Available only when the versa compartment is set to soft freezing (low, medium or high).

■ Supercool freezing **▶ Page 15**

## Sets the ice making compartment

- Selecting the ice making mode **▶ Pages 13, 25**
- When **ICETRAY** is on **▶ Page 13**
- If you will not make ice for a long time **▶ Page 25**
- Cleaning the ice tray **▶ Page 26**



## About the door alarm and interior lamp

The door alarm sounds when the refrigerator, ice making or freezer compartment door is open for 1 minute or longer. When a door is open for 4 minutes or longer, the interior light of the refrigerator compartment blinks to alert you.

The door alarm frequency and the interior light operation vary depending on how long the door has been open. See below for details.

Door open time	1 minute	2 minutes	3 minutes	4 minutes	5 minutes or longer
Alarm	2 beeps	3 beeps	4 beeps	Continuous long beeps	Continuous short beeps
Interior light	On			Blinks twice per minute	

- The compartment display on the control panel blinks in time with the door alarm sound.
- Check for an ajar door or trapped food (packing, rear side of the drawer cases). (Check at least once a month.)
- If the alarm keeps sounding even after closing the doors, contact the retail store where you purchased the refrigerator.

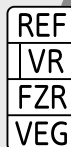

Blinks in time with the door alarm

## If the control panel display blinks

The refrigerator is in the demonstration operation when the entire display blinks 3 times in regular intervals, or the compartment display and temperature control display blinks repeatedly in order. The refrigerator does not cool in this mode.

Cancel the demonstration operation.

**▶ Page 30**

# Compartment Temperature Control

## Setting the temperature in the refrigerator, vegetable and freezer compartments

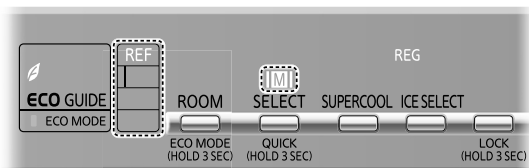

\* Display example

**1** Press **ROOM** to display the compartment that you want to set.

The compartment display changes each time the button is pressed.

**2** Press **SELECT** to set the temperature.

The display changes each time the button is pressed.

Temperature control					
Compartment display	When cooling is too strong	When cooling is a little too strong	Standard*1	When you want to cool a little more	When you want to cool more
REF			About 0 to 6°C	About 1 to 2°C lower than medium	About 2 to 3°C lower than medium
FZR*2	2 to 3°C higher than medium	1 to 2°C higher than medium	About -22 to -16°C		
VEG			About 3 to 9°C	About 0 to 1°C lower than medium	About 1 to 2°C lower than medium

\*1: The setting at installation (at time of purchase).

\*2: This temperature is different from the freezer setting of the versa compartment.

(About temperature control for the versa compartment ► **Page 14**)

- To control the temperature more precisely ► **Page 31**
- To set the freezer compartment to a lower temperature ► **Page 30**

### Note

- The temperatures described here are measured in the lower center of the refrigerator after the temperature has stabilized when the surrounding temperature is 30°C and the doors are closed without any food inside. The temperature fluctuates with factors such as the food storage condition and how often the doors are opened and closed.
- Before and after defrosting, the temperature inside the refrigerator may drop or rise temporarily.

## Fast cooling (QCK)

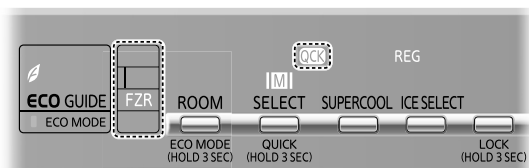

\* Display example

**1** Press **ROOM** to display the compartment that you want to set for fast cooling.

The display changes each time the button is pressed.

► REF → VR → FZR → VEG

**2** Press **SELECT** for about 3 seconds.

(Until the buzzer sounds twice.)

**QCK** lights up.

- **QCK** stops automatically after about 2 hours.  
(After stopping, **QCK** goes off and the temperature reverts to the set temperature.)
- When the versa compartment is set to soft freezing, **QCK** is not available. (A buzzer sounds 3 times.)

### Stopping before the cooling ends

**1** Press **SELECT** to turn off **QCK**.



### When should I use **QCK**?

For example, after you have bought a lot of food and you want to freeze them quickly to preserve their freshness.

- You can use fast cooling even when other food is inside!
- The operation sound gets louder during fast cooling, because the refrigerator operates at high speed.

# Selecting the Ice Making Mode

## Setting the ice making compartment

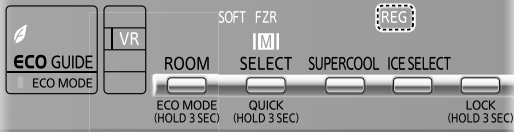

\* Display example

**1** Press **ICE SELECT** to select the ice making setting.

The display changes each time the button is pressed.

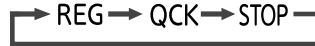

- Set to **REG** at installation.
- Making ice ▶ **Page 25**

### About the ice

- The size of the ice depends on various factors, such as the amount of water in the water tank.
- About 10 to 12 ice cubes can be made each time.
- If the ice is stored for a long time, the ice cubes may join together or shrink. (Due to a phenomenon called sublimation.)
- If you try to crush ice that has joined together, be careful not to injure your hands.

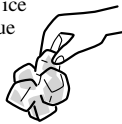

### About quick ice making

- In the following cases, quick ice making is stopped automatically.
  - When the ice storage box is full (about 80 to 140 ice cubes)
  - When there is no water in the water tank
  - When about 10 hours have passed in quick ice making mode (The display changes from **QCK** to **REG**.)
- The operation sound gets louder during quick ice making, because the refrigerator operates at high speed.
- It may take more than 24 hours to make ice immediately after installation, even in quick ice making mode.
- When quick ice making is performed, the ice may split or crack because the freezing is performed quickly.

Display	Ice making setting	Application	Approximate ice making time
REG	Regular ice making	When you want to make ice	110 to 130 minutes
QCK	Quick ice making	When you want to make ice quickly	80 to 100 minutes
STOP	Stop ice making	When you want to use as a 2-star compartment <sup>*1</sup> , or you want to clean the ice making compartment	-

- The ice making time is the approximate time for a single batch (10 to 12 ice cubes).
  - In addition to the surrounding temperature, water type, and water volume and temperature in the water tank, the ice making times may vary with the following conditions, and be longer than those described above.
    - When the ambient temperature is low, such as during winter
    - When the doors are frequently opened and closed
    - When the freezer compartment is set to low
    - When the refrigerator is set to ECO mode
    - When the ice tray is pulled out and reinserted during ice making
- \*1: For short term storage of frozen food. Not to be used for long term storage of frozen food or ice cream.



### Ice tray precautions

When **ICE TRAY** is on

- The **ICE TRAY** display lights up when the ice tray or ice tray lock lever is not installed correctly.
- Before making ice, install the ice tray and lock the ice lock lever, making sure that **ICE TRAY** is off.

When the ice making setting is blinking

- When any of **REG**, **QCK** or **STOP** is blinking, the ice tray is operating.
- Do not remove the ice tray while it is operating. Doing so may cause an injury.
- If you open the ice tray door while the ice tray is operating, you will be alerted by a repetitive buzzer.

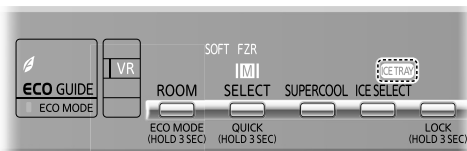

Ice tray is not correctly installed

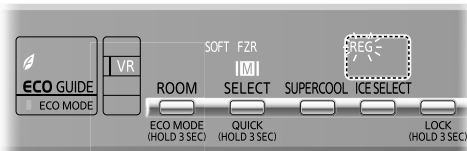

Ice tray is operating (regular ice making setting)

\* Display example

To save power, the control panel display turns off if there is no operation for about 30 seconds. (The settings are saved.)

To check the setting (or operation) status, press a control panel button to light up the display.

# Versa Compartment Temperature Control

## Setting the versa compartment temperature

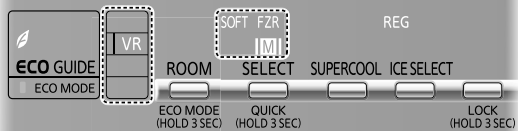

\* Display example

**1** Press to display VR.

**2** Press to set the temperature.



### Difference between freezing and soft freezing

The storage time is not the same due to difference in their temperature.

Separately use soft freezing and freezing with reference to the table on the right.

Display	Application	Other functions
SOFT FZR	When storing food such as meat or fish with soft freezing for <b>about 2 to 3 weeks</b>	Supercool freezing ▶ <b>Page 15</b>
FZR	When storing meat, fish and other processed food for <b>about 1 month</b>	Fast cooling ▶ <b>Page 12</b>

\* This temperature is different from the freezer compartment temperature.

### Temperature control

SOFT FZR			FZR		
About -5°C	About -7°C	About -9°C	About -12°C	About -15°C	About -18°C
<b>For food frozen too hard to cut and food with a lot of moisture.</b> • Boiled vegetables • Large blocks of meat with not much fat 	<b>The optimum temperature for soft freezing.</b> Can be frozen with package. 	<b>For food that is difficult to freeze and food containing a lot of salt or sugar.</b> • Food pickled in soy sauce or miso • Cod roe 	<b>For preserving food containing a lot of salt or sugar.</b> Enjoy the texture of the food. 	<b>For preserving food that was frozen at home.</b> 	<b>For preserving frozen food that was purchased, such as ice cream.</b> Preserves ice cream at the optimum hardness for comfortable eating. 
			Ice cream or frozen food that was purchased cannot be stored in modes FZR  or FZR .		

■ To control the temperature more precisely ▶ **Page 31**

### Note

- Before and after defrosting, the temperature inside the refrigerator may drop or rise temporarily.
- The temperatures described here are measured in the lower center of the refrigerator after the temperature has stabilized when the surrounding temperature is 30°C and the doors are closed without any food inside. The temperature fluctuates with factors such as the food storage condition and how often the doors are opened and closed.
- After changing from freezing to soft freezing, it takes some time for the temperature inside the refrigerator to stabilize. (About 2 hours.)

# Freezing for Delicious Food (Supercool Freezing)

## Setting supercool freezing

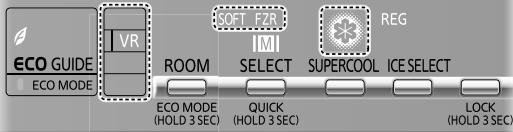

\* Display example

**The supercool freezing operation is the same for hot food and cold food.**

The HIKARI sensor detects the food temperature to automatically determine the appropriate cooling.

### Stopping before the cooling ends

**1** Press **SUPERCOOL** to turn off .



**1** Press **ROOM** to display **VR**.

**2** Check that **SOFT FZR** is displayed.

- If the setting is **FZR**, set to **SOFT FZR** and wait until the temperature stabilizes (after about 2 hours) before performing step **3**.  
(Supercool freezing cannot be performed in the freezer mode.)

**3** Press **SUPERCOOL**.

 lights up.

- If 30 seconds pass without any control panel button operations, all displays other than  turn off.
- Supercool freezing finishes automatically after about 3 to 12 hours\*.  
( turns off.)

\* The time varies depending on the amount, temperature and type of food.

- After supercool freezing finishes, the food is stored with soft freezing.



**What happens when food is frozen with supercool freezing?**

For more tips, see the next page 

**Hot food such as freshly cooked rice or curry**



**Supercool freezing of hot food**

- Freezing for delicious food with its moisture and flavor preserved.

**Main ingredients such as meat or fish**



**Freezing for delicious food that does not lose its taste and texture**

- When thawing meat, hardly any juiciness is lost.
- The texture is preserved even in food such as potatoes, bamboo shoots, and broccoli.

- You can use supercool freezing even when other food is inside!

**Supercool freezing finished**

**The food is easy to cut even when frozen.**



- Although the food looks like it is frozen, it can be taken out and cut with a kitchen knife.

**Soft freezing makes storage more convenient**



- If you want to store the food for a long time, move it to the freezer compartment after supercool freezing has finished.

### Note

- The door of the versa compartment can be opened and closed even during supercool freezing.
- Supercool freezing can only be performed in the versa compartment. Supercool freezing cannot be performed when the versa compartment is set to **FZR**.  
(A buzzer sounds 3 times and  is not displayed.)
- Even when supercool freezing is operating,  is not displayed unless the compartment selection is **VR**.
- If the versa compartment setting is changed to **FZR**, the supercool freezing finishes.

Before Use

Operation

Cleaning

Troubleshooting

# Tips for Supercool Freezing and Soft Freezing

Supercool freezing ❄️

## Step 1

### What about storage containers?



**Use plastic wrap to cover containers or wrap rice.**



Avoid using aluminum foil or paper wrapping, because it interferes with accurate measurement of the food temperature.



**When storing food in sealed containers, stuff the food until the container is full.**

If there is not much food in a container, the food temperature may not be measured accurately.

#### What about hot food?

**Do not store food that is hotter than 80°C.**

**Example: Freshly cooked rice is about 70°C**



If food is too hot it may deform nearby containers. Also, when food is too hot to hold with your bare hands, be very careful not to burn yourself.

### You can supercool freeze hot food!

Freeze without losing moisture and taste.

#### Rice

For leftover rice, divide it by the amount per serving and wrap them, while still warm and supercool freeze it.

It can be preserved for about 2 weeks with soft freezing. It thaws well with no unevenness.

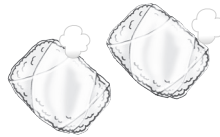

#### Curry

Leftover curry can be put in the versa compartment while still hot for supercool freezing.

Even curry containing potatoes can be stored without losing its texture and taste.



#### Sauces

Freshly cooked sauces can be poured into a storage container while still hot for supercool freezing. After hardening, the sauce can be diced and put into a storage bag, which takes up less space and lets you take out only the amount that you need each time.

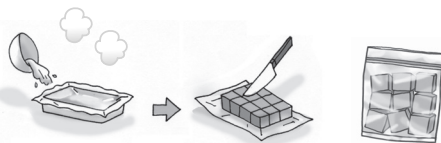

#### Potatoes and broccoli

Boiled vegetables to be used in croquettes or salads can be cooled down using supercool freezing.

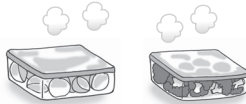

### Storing meat and fish with soft freezing

Store meat and fish with soft freezing and take it out just before you use it. You can easily cut the soft frozen food using a kitchen knife.

#### Blocks of meat

We recommend using blocks of meat of about 100 to 400 grams for supercool freezing. Meat that has been stored in the freezer or was purchased frozen can be transferred to soft freezing.

- Depending on the size of the food, it can be cut 2 to 5 hours after transferring from the freezer compartment.



#### Thinly sliced meat or bacon

Can be cut without thawing. They will thaw while basting, when you can easily separate them.

- If they cannot be separated immediately after removal, wait for a while and try again.



#### Ground meat

You can cut out the required amount with a kitchen knife. If you cut the meat into cubes and leave them in room temperature for about 15 to 30 minutes, they will have thawed enough to be kneaded by hand.



#### Cutlets and cod roe

Cutlets can be cooked on a low flame without thawing them first.

Food with a high salt content, such as cod roe, does not freeze and so can be used immediately.



#### Note

- When performing soft freezing after freezing, or freezing after soft freezing, use the food within a short period of time (about 1 to 2 weeks).

Before Use

Operation

Cleaning

Troubleshooting



## Step 2 When placing food inside

### Supercool freeze together at the same time.

- If more food is added afterward, the supercool freezing may not work.
- If hot food and cold food below room temperature are placed inside at the same time, priority is given to cooling the hot food.

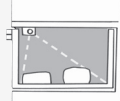

The HIKARI sensor (infrared sensor) monitors the food condition from the top of the versa compartment. Arrange the food to make it easy for the sensor to measure the temperature.

## Step 3 Where should the food be placed?

Lay out the food for supercool freezing flat and on top in the versa compartment.



- When food is hidden behind its temperature cannot be measured accurately.

We recommend that hot food be separated from the frozen food and placed at the front.

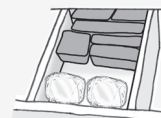

- The hot food may touch and thaw the frozen food.

## Delicious fruit and desert recipes

Sweet fruits are recommended. You can enjoy a wide range of supercool frozen fruits.

Mix supercool frozen fruit with yoghurt and milk in a blender to make a simple, healthy drink. It is also easy to make healthy low-sugar jam or ice cream.

### Watermelon

Make watermelon ice by cutting watermelon into bite-size pieces and supercool freezing them. You can try with lots of different fruits.



### Frozen yoghurt

Sugared yoghurt can be supercool frozen while still in its cup. After one night, it becomes a fine, smooth ice cream.



### Smoothie (apple and kiwi smoothie)

- ① Cut half a peeled apple into large bite-size pieces, and a peeled kiwi into circular slices with a thickness of 1 cm. Supercool freeze them.
- ② Put the supercool frozen apple and kiwi into a blender with 250 cc of milk and some honey (if you like), and blend until smooth (makes 2 servings).



### Jam (strawberry jam)

- ① Put 1 pack of strawberries (about 300 grams) into a container and mash them thoroughly.
  - ② Mix in 60 to 100 grams of sugar (depending on the sweetness of the strawberries) and supercool freeze the mixture.
  - ③ Leave for one night and it turns into a tasty strawberry jam.
- Easy to make from even a small amount of fruit. Try next time you have some leftover fruit!
  - Do not store in a glass container. It may break.



### Note

- When fruit is thawed it does not return to its original condition. Eat frozen fruit without thawing it.
- The freezing time varies depending on the sugar content. Leave for one night after supercool freezing.
- If fruit is stored for more than a week with soft freezing, its taste may change. To enjoy the fresh texture, we recommend eating within 2 to 3 days.

## Others

### Natto

Natto can be mixed immediately after removal from the compartment.

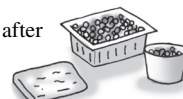

### Fried bean curd

You can cut out the required amount.

### Food not suitable for supercool freezing or soft freezing

#### Food that has already thawed once

The texture and quality cannot be guaranteed.



#### Food that cannot be frozen

(Konjac (devil's tongue), tofu, milk, raw eggs, etc.)

The preservation of the pre-freezing texture and quality cannot be guaranteed.



#### Ice cream or frozen food that was purchased

Store in the freezer compartment.

### Note

- With supercool freezing and soft freezing, food is frozen at about  $-7^{\circ}\text{C}$ , so it takes about 24 hours for the food to freeze completely.
- Even after supercool freezing has finished and  turns off, the food may not be completely frozen.
- When placing more food inside additionally, refrain from opening the doors often.
- Supercool freezing may not be possible or the degree of freezing or freezer burn may vary depending on the food type, cooking method, storage arrangement (stacking, storage location), the amount of food, and the storage time.
- Depending on how much sugar, salt or fat that the food contains, freezing may not be possible or the food may harden when frozen (cannot be cut immediately with a kitchen knife).
- If the food has frozen hard, leave it for about 5 to 15 minutes at room temperature and you should be able to cut it with a kitchen knife.
- Set the temperature according to how the food is frozen.

# Power Saving (ECO MODE, ECO GUIDE)

## Setting ECO MODE

Performs the power-saving operation automatically when the temperature inside the refrigerator is stable.

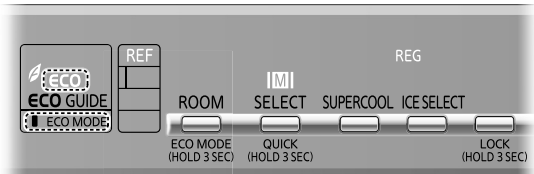

\* Display example

- 1 Press **ROOM ECO MODE (HOLD 3 SEC)** for about 3 seconds.  
(Until the buzzer sounds twice.)  
■ ECO MODE lights up.

To cancel

- 1 Press **ROOM ECO MODE (HOLD 3 SEC)** for about 3 seconds.  
(Until the buzzer sounds twice.)

### Note

- **ECO** lights up when ECO mode is set and the power-saving operation is started.
- Even when ECO mode is set, the power-saving operation may stop and **ECO** may go off, for example when the doors are frequently opened, after defrosting, or during fast cooling. (After the freezer compartment is sufficiently cooled and the temperature is stable, the power-saving operation is restarted automatically.)

## About the ECO GUIDE

The ECO Level of the previous 24 hours is determined by factors such as the temperature settings of the compartments and the frequency of opening the doors, and is indicated by the number of leaves.

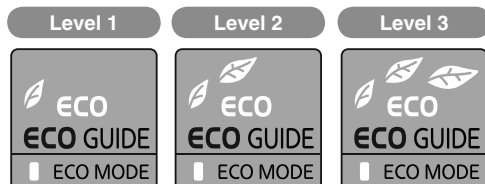

\* When the level is 0, one leaf blinks slowly.

- The ECO Level is indicated in 4 levels from 0 to 3.
- The better the ECO Level, the higher the number of leaves.
- The ECO Level is updated about once 1 hour.  
(If there is no change in the ECO Level, the number of leaves does not change.)
- Initially (at the time of purchase), one leaf is displayed.
- ECO GUIDE is displayed even when ECO mode is not set.
- After a (refrigerator, freezer or ice making compartment) door is closed, the ECO GUIDE and ECO mode displays light up for about 30 seconds. Then, they go off.



### How can I increase the ECO level? (Tips for power saving)

#### Set ECO MODE

When the temperature inside the refrigerator is stable, the power-saving operation is performed automatically. This is not set initially.

#### Use a higher temperature setting

When a higher temperature setting is used in each compartment, the power consumption is reduced. We also recommend setting the versa compartment to soft freezing.

#### Set the anti-condensation heater to low

When the humidity is low, setting the anti-condensation heater to low helps save power. ► **Page 30**

#### Do not open the doors more than necessary, and close them as soon as possible

If doors are opened frequently or are kept open for a long time, cold air escapes from the refrigerator and more power is consumed.

- Even when a door is open only slightly, it can cause frost or condensation, reduce the cooling performance, or generate water drips.

#### Arrange the food carefully

If too much food is packed inside the refrigerator or the air outlets are blocked, the flow of cold air is impaired, which inhibits the cooling of the food inside.



Be careful not to trap items such as food, plastic bags, or the power cord in the doors.



Keep a gap between food



Wait until hot food has cooled before placing it inside. (Hot food can be put in when using supercool freezing!)

# Other Settings



## (Child Safety Lock, Setting Reset)

### Setting the child safety lock

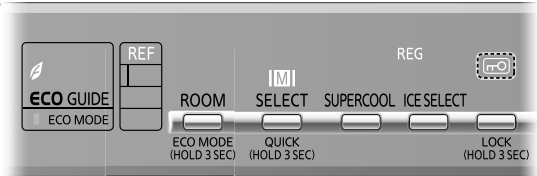
Locks the control panel to prevent accidental button operation by children.



\* Display example

- 1 Press  for about 3 seconds.  
(Until the buzzer sounds twice.)  
 lights up.

To cancel

- 1 Press  for about 3 seconds.  
(Until the buzzer sounds twice.)

#### Note



- Even when the child safety lock is set, the compartment selection can be operated.

### Resetting

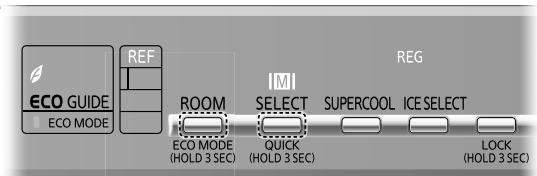
Returns the compartment selection, temperature control, fast cooling and supercool freezing settings to their initial condition (at the time of purchase). Use, for example, if you have forgotten the settings.



\* Display example

- 1 Press  and  at the same time for about 3 seconds.  
(Until the buzzer sounds twice.)

#### Note

- The temperature setting for the versa compartment does not change.
- When the ice making setting is QCK, it changes to REG. If in other settings, it does not change.
- Fast cooling and supercool freezing are canceled.

To save power, the control panel display turns off if there is no operation for about 30 seconds. (The settings are saved.)

To check the setting (or operation) status, press a control panel button to light up the display.

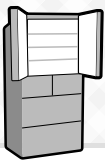

# Refrigerator Compartment

## Precautions for using the Revolving Shelf

Before closing the refrigerator door, return the Revolving Shelf to its original position.

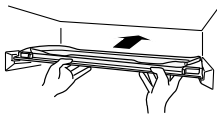

Do not hang on the Revolving Shelf.

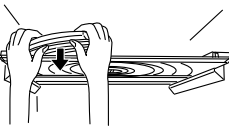

Do not place items as they are protruding from the Revolving Shelf.

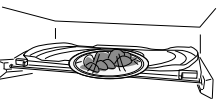

Do not place the following items on the Revolving Shelf.

- Stacked items that slide easily, such as glass bottles.
- Items that spill easily.
- \* Do not place items with a total weight of 10 kg or more on the Revolving Shelf.



Otherwise food may fall and cause injury, or damage to a shelf or pocket.

## Two-way flexishelf

## Interior light

When a door is open for more than 4 minutes, the interior light blinks twice a minute to alert you. If the light stays on continuously for 60 minutes, it turns off. If the door is then closed, the interior light turns on again when the door is opened.

## Revolving Shelf

## Ceiling air outlets

## Adjustable pocket (small)

## AUTO Shelf

## Bottle pocket (small)

## Rotating partition

## Chilled egg compartment

## Egg Shelf

## Small item case

## Slide chilled case

Do not close the door while the rotating partition is opened out to the front.

If you open or close the doors with force, the rotating partition may open to the front. Open and close the doors slowly. (Otherwise damage may result.)



Use to store food such as meat, fish, processed food (minced fish, ham, etc.) and yoghurt.



About -3 to 3°C

## Set automatically

- The temperature cannot be set with the control panel.
- Do not place food that freezes easily.

\* If food with a high level of moisture is placed near the air outlets, it may freeze. ► Page 32

■ If the door alarm sounds ► Page 11

## Wrap food that have strong odors thoroughly before storage

### Food that transfers odors easily

Rakkyo, dried fish, natto, miso, beef, takuan, sardines, kimchi, jiaozi, etc.

- A slight odor may remain.

### Food to which odors are easily transferred

Puddings, ice cream, potato salad, tofu, rice, bread, milk, cake, ice, etc.

- A slight odor may remain.

### Adjustable pocket (large)

### Blue LED

Bacteria and odors are removed with HIKARI power. If the light stays on continuously for 5 minutes, it turns off.

### Air outlets

### Bottle pocket (large)

Do not leave food hanging over shelves or pockets. Do not place glass bottles that cannot fit all the way to the bottom at the front of the bottle pocket.

The bottle may keep a door ajar, or the bottle may break.



Do not attach a case that you purchased separately onto the outside of a pocket.

It may keep a door ajar and reduce the cooling performance, or food may fall and cause an injury or damage to a case or lid.

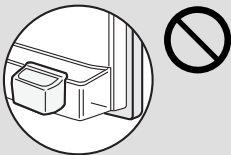

Do not close the door while food is in front of the slide chilled case or the small item case.



Fully stow away the cases.

### Note

- If food freezes in the following kinds of situations, set the refrigerator compartment temperature to "M", "L M" or "L".
  - When the refrigerator compartment temperature is set to "H"
  - In winter or at other times when the surrounding temperature is 5°C or less
- Page 12
- A long-life LED is used as the interior light, so usually replacement is not required.

## You can move the shelves and pockets (You can also remove them)

### Revolving Shelf

- ① Open the refrigerator compartment doors (left and right).
- ② Slide the left and right levers to the side to release them.
- ③ Rotate slowly while holding the edge of the tray. (The tray can be turned in both directions, to the left or the right.)

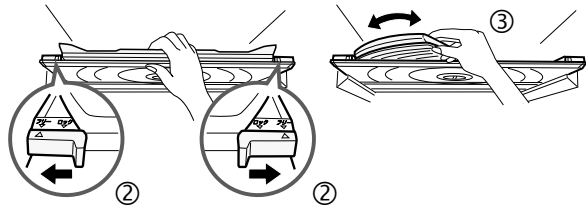

After operating the shelf, return it to its original position by following the procedure in reverse. Then, set the left and right levers to the lock position to fix the shelf.

■ Removing and installing the Revolving Shelf ► Page 28

### AUTO Shelf

Move the lever to the left or right to adjust the space between the shelves.

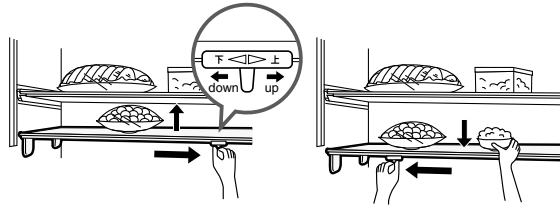

If the AUTO Shelf disengages, push it back into position from above.

■ Removing and installing the AUTO Shelf ► Page 28

### Two-way flexishelf

#### 1 As a wide shelf (One)

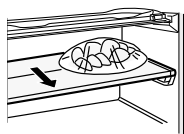

#### 2 Halve the shelf width to store tall objects (Two)

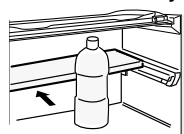

### Adjustable pockets

Adjustable to 2 positions

Small Large

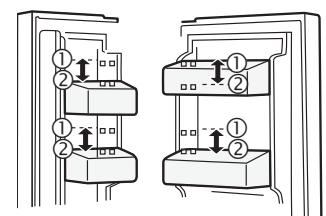

■ Removing the pockets

► Page 29

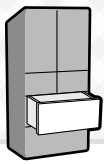

# Freezer Compartment

Before Use

Freezing case (upper)

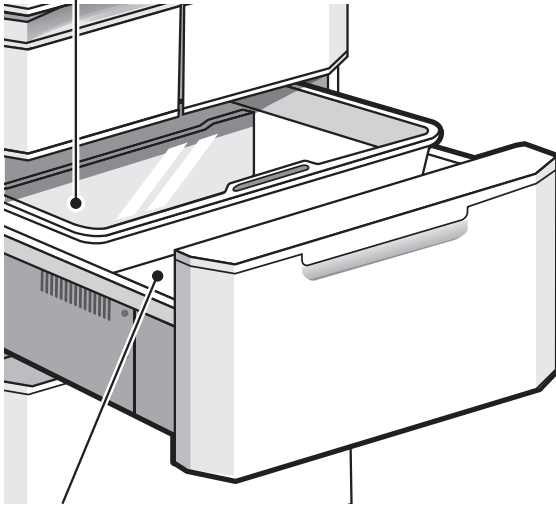

Freezing case (lower)

Do not place tall objects in the freezing case (lower).

- Food or the slide case may be damaged.
- The door may not be closed.

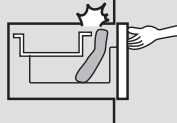

500 ml plastic bottles for freezing can be placed standing up in the compartment.

Do not put in plastic drink bottles other than those for freezing.

The frozen contents may break the bottle.

► Page 5

When the door is open, the door alarm sounds to alert you.

Check for a gap such as an ajar door or trapped food (packing, rear side of the drawer case).

\* Check at least once a month.

► Page 11

Operation

Cleaning

Troubleshooting

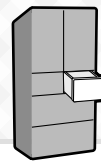

# Versa Compartment (Supercool Freezing Room)

HIKARI sensor (infrared sensor, blue LED)

The food temperature is detected with an infrared sensor.

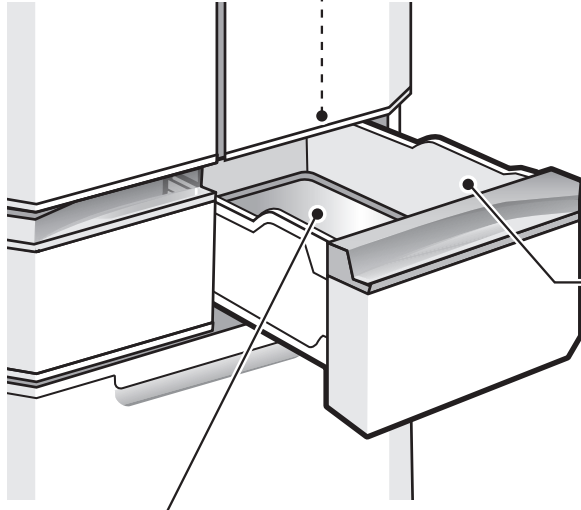

Aluminum tray

The cold tray quickly cools the food.

Do not stack food higher than the case.

- The door may not be closed.
- Food may be damaged.
- Food may be thawed.

Freeze to your taste!

**Difference between freezing and soft freezing**

► Page 14

SOFT FZR

- When soft-freezing food such as meat or fish for about 2 to 3 weeks.
- When supercool freezing food.

FZR

- When storing meat, fish and other processed food for about 1 month.

Cold air sterilized<sup>\*1</sup> and deodorized with light!  
Minimizes the transfer of odors.

**About the blue LED in the versa compartment**

The operation of the blue LED in the versa compartment is linked to the blue LED inside the refrigerator compartment.

- ① The blue LED turns on when a refrigerator compartment door is opened.
  - ② Also in cases other than the above, the refrigerator may automatically turn on the blue LED.
- \* The blue LED does not always turn on when the versa compartment door is opened.

<sup>\*1</sup> The effect has been proven after 18 hours in a test using a 12cm<sup>2</sup> filter bacteria-inoculated in a sealed container with a 12 cm<sup>2</sup> filter, but these conditions vary from the actual operation conditions.

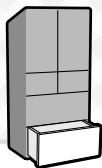

# Vegetable Compartment

Do not disassemble the LED or expose it to water

- Exposing the LED to water may break it.
- A long-life LED is used, so usually replacement is not required.

Orange LED (upper area)

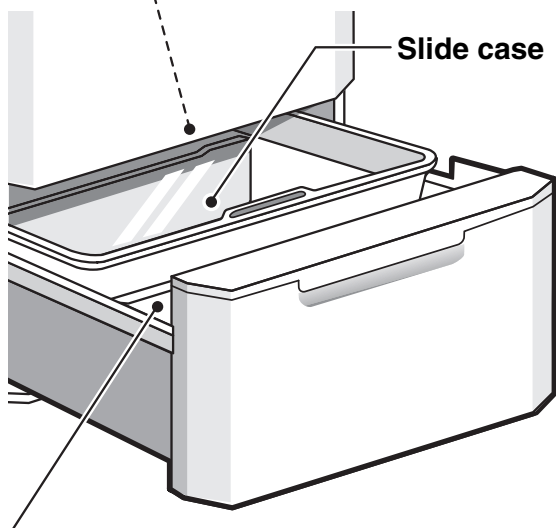

**Vegetable case**

Fits 2 L plastic bottles.

Do not place tall objects on the vegetable case.

- Food or the slide case may be damaged.
- The door may not be closed.
- If the slide case is removed, the vegetable compartment becomes dry.



Bathed in light to increase the nutrients! Vitamins boosted up ↑

**The orange LED is always on.**

Storing fruit and vegetables in plastic wrap keeps them even fresher.



- Vegetables stay alive even after harvest. Being bathed in light, their nutrients are boosted up.
- There is almost no vegetable, fruit, drink or seasoning that cannot be preserved or stored being exposed to light.
- The vegetable nutrients are increased even with a weak light, so packaging does not need to be removed (except when the packaging completely blocks off the light).
- The vegetable nutrients are not increased forever. The preservation also depends on the freshness at the time of purchase. Eat vegetables when they are as fresh as possible.
- Because the vegetable compartment has a high humidity, fogging or condensation may form on the roof of the vegetable compartment or the bottom of the cases. Condensation forming on the bottom may make the case dirty, so wipe it off with a dry cloth.

Versa case

Before Use

Operation

Cleaning

Troubleshooting

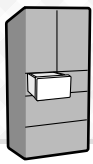

# Ice Making Compartment (Automatic Ice Maker)

Before Use

Operation

Cleaning

Troubleshooting

**Water tank cap**

**Water tank lid**

The lid can be set on the tank in both directions, facing the front or rear.

**Water tank  
(about 1.2 L)**

**Pipe  
Water supply pump  
Optical catalyst and  
lead-cleaning filter**

**Ice tray**  
It can be removed for cleaning.

**Soundproof mat**  
Reduces the sound of dropping ice.  
Do not dispose of it.

**Ice server**

**Ice storage box    Ice tray lock lever**

**Water tank setting  
position line**

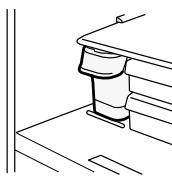

This is the guideline for the water tank setting position.  
Push in the water tank until it makes contact with the inner side. Make sure that the line can be seen in front of the water tank.



**Water supply pipe**

**V-LED lamp**

Light is radiated on the optical catalyst and lead-cleaning filter to prevent breeding of bacteria\* inside the water tank.

\* The effect has been proven after 18 hours in a test using a 12cm<sup>2</sup> filter bacteria-inoculated in a sealed container with a 12 cm<sup>2</sup> filter, but these conditions vary from the actual operation conditions.

The V-LED lamp turns on

- When the refrigerator compartment or ice making compartment door is open (the light turns off 5 minutes after the door is opened)
- Before and after supplying water to the ice tray

- Clean the ice maker periodically to ensure that the ice is pure and delicious. ► **Page 26**
- If the door alarm sounds ► **Page 11**



## Ice making precautions

Do not place objects at the rear of the ice storage box.

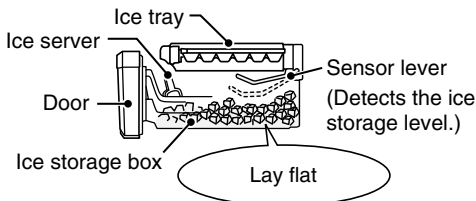

- Do not store food higher than the ice storage box (because it may cause an ajar door, malfunction or damage).  
When using the regular or quick ice making setting, do not put anything other than ice.
- The level of the ice storage is checked automatically by the sensor lever, and ice making is stopped when the ice reaches a certain level (about 80 to 140 ice cubes). To ensure that the ice storage level is detected correctly, make sure that the ice is flat and that the ice server is kept in its storage position in the front right of the ice storage box.

Do not pour anything other than cold water into the water tank, such as warm water, juice, tea or other liquids (the tank can resist heat up to 60°C).

Pouring anything other than cold water into the tank may damage the automatic ice maker or water supply pump.



Do not pour water directly into the ice tray to make ice.

Unfrozen water in the ice tray may fall into the ice storage box, and the ice may join not forming cubes.

When ice is made using water with a high mineral content, such as mineral water, white deposits (white crystals) may form in the ice.

This is the crystallized mineral content and is not harmful.



## Making ice

**1** Press **ICE SELECT**  on the control panel and select **REG** or **QCK**.

► Page 13

**2** Make sure that **ICETRAY** on the control panel is not on.

- If the lamp is on, insert the ice tray and lock the ice tray lock lever.

► Page 26

**3** Remove the water tank.



Water tank

**4** Slide the water tank cap and pour water into the water supply port up to the full position.

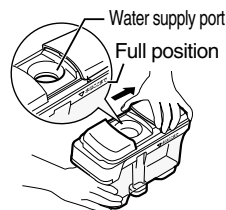

- If water is filled beyond the full position, water may spill when you carry or tilt the tank. Further, it may cause the water channels in the ice tray to freeze, or the ice to join together or form a protrusion.

WARNING-Fill with potable water only.

**5** Close the water tank cap, and while holding the water tank horizontally, push it in until it makes contact with the inner side.

- If there is a gap between the water tank and the water supply pipe, the water tank may freeze. Check that there are no foreign objects between the tank holder and the water supply pipe area. ► Page 26
- Push in the water tank until it makes contact with the inner side. Setting the water tank incorrectly may prevent ice from forming.

Return the water tank to its original position

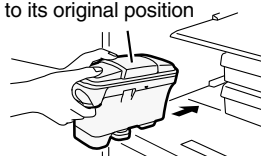

Note

- When carrying the water tank, hold the tank with both hands. (If you hold the lid, the tank may fall and cause an injury.)

## Stopping ice making (When not using for a long time)

Empty the ice tray and water tank.

**1** Set the ice making setting of the ice making compartment to **STOP**.

► Page 13

**2** Remove the water tank and empty the water.



Water tank

**3** Remove the ice tray and empty the water and ice.

- For details on removal, see the page that describes the cleaning methods. ► Page 26

**4** Remove the ice storage box and empty the water and ice.

- Do not dispose of the soundproof mat.

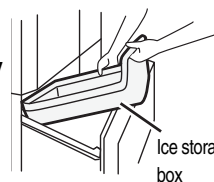

Ice storage box

**5** Wash the water tank (water supply pump, pipe, optical catalyst and lead-cleaning filter), water supply pipe, ice storage box, soundproof mat, ice tray and ice server, dry them completely, and then return them to their original positions.

► Page 27

- If the water tank is not returned to its original position, the food inside the refrigerator compartment may freeze.

Return the water tank to its original position

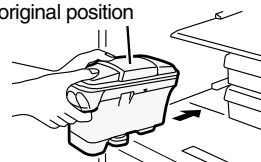

Note

- Wash the water tank, water supply pipe and ice tray before making ice for the first time, or if you have not made ice for more than a week. Odors or dust may be adhered to the parts.

Before Use

Operation

Cleaning

Troubleshooting

# Cleaning the Automatic Ice Maker

Clean the ice maker periodically to ensure that the ice is pure and delicious.

**Prevents formation of water scale and mold.**

\* Do not use a dishwashing machine, because it may deform the parts.

Before Use

Operation

Cleaning

Troubleshooting

once a week **Water tank**

**1 Remove the lid and wash it.**  
(Upper temperature limit about 60°C)

\* If mold forms easily because of the type of water, clean about 2 or 3 times a week.

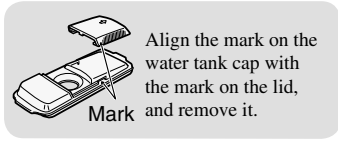

When using bleach to clean the water tank and lid, follow the product instructions.

once a month **Water supply pipe and tank holder**

**1 Pull out the water supply pipe and wipe the tank holder with a clean cloth.**

- Do not rinse the tank holder with water. Doing so may cause a malfunction.
- If the water supply pipe is not installed, the food inside the refrigerator compartment may freeze.

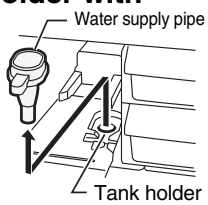

**2 Disassemble and wash the parts.**

- Rotate and remove the aluminum pipe.
- \* White minerals or chlorine accumulation may be adhered to the parts, but this is not abnormal. Wash off such substances and reuse the parts.

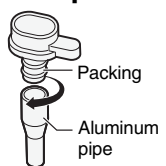

**3 Follow the procedure in reverse to return the parts to their original positions.**

- Push in the water supply pipe firmly so that there is no unevenness. Using while unevenly set may cause a malfunction.

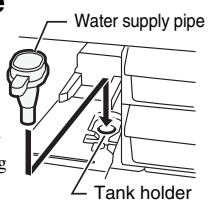

**4 Check that there are no foreign objects between the water supply pipe and the tank packing or tank holder.**

- If the parts are not inserted firmly or there are gaps due to foreign objects, it may cause abnormal noise or prevent ice from forming. It may also cause the water in the water tank or food in the refrigerator compartment to freeze.

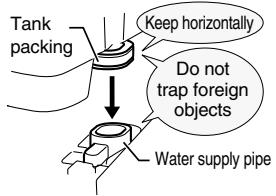

1-2 times a year **Ice tray**

**1** Press **ICE SELECT** to select **STOP**. ▶ Page 13

- The ice tray is operating while **STOP** is blinking. Close the door and wait until the blinking finishes.
- The door alarm sounds if the door is opened while the ice tray is operating.

**2** Open the door of the ice making compartment and unlock the ice tray lock lever.

- When the ice tray lock lever is unlocked the **ICE TRAY** display turns on.

**3** Pull the ice tray towards the front and then remove it.

- There is a risk of the water spilling. Pull out the tray slowly.

**4** Empty the ice tray and wash it.

- After washing the tray, dry off any moisture.

**5** Push in the ice tray until it makes a clicking sound, and then lock the ice tray lock lever.

- Check that **ICE TRAY** is off. If the lamp is on, check the position of the ice tray lock lever.

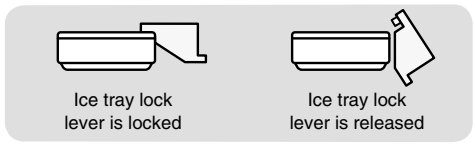

**6** Press **ICE SELECT** to select the ice making setting.

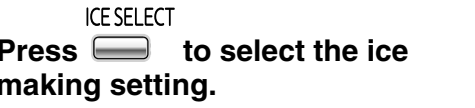



## Do not use the following for cleaning.

Items such as sponges or scrubbers that may damage surfaces, or cleaners such as alkaline detergents, scouring powder, boiling water, oil or acid

once a month

## Pipe, water supply pump, and optical catalyst and lead-cleaning filter

- 1 Pull out the pipe and packing, and rotate and remove the water supply pump.**

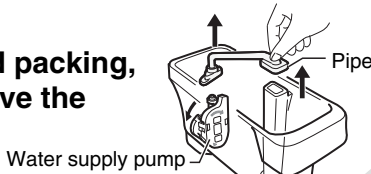

When setting, align the mark on the tank with the mark on the packing.



- 2 Disassemble the parts and wash them.**

The impeller is made from a magnet. Wash it thoroughly to remove any foreign objects.

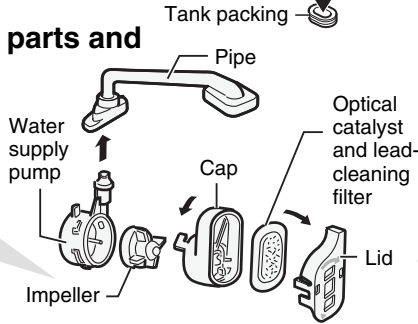

Do not use cleaners such as kitchen detergents, benzene or bleach to clean the optical catalyst and lead-cleaning filter.  
• Doing so may result in odors of the ice.

Remove the cap while opening the tab with your finger.

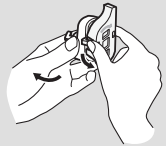

- 3 Follow the procedure in reverse to return the parts to their original positions.**

- If the packing is not set, the water inside the water tank and food inside the refrigerator compartment may freeze.
  - Replacement is not usually required for the optical catalyst and lead-cleaning filter. However, it may require replacement in the following cases.
    - When it clogs because something other than water was put in the tank
    - When it is damaged
    - When mold has formed
- To purchase a new filter, contact the retail store where you purchased the refrigerator.  
\* If mold forms easily because of the type of water, clean about 2 or 3 times a month.

Note

## Procedures for returning the water supply pump and pipe to their original positions

Incorrect assembly may prevent ice from forming, or increase the operation noise.

### Assembling the water supply pump

### Installing the pipe

- 1. Fit the filter into the cap.**

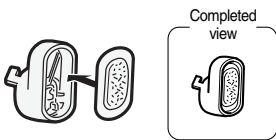

- 2. Fit the lid onto the assembly made in step 1.**

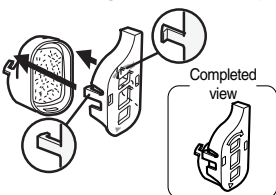

- 3. Attach the impeller onto the water supply pump.**

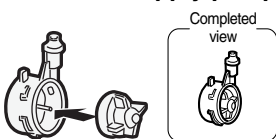

- 4. Rotate and fix the tab (1) of the cap in step 2 into the projection (2) on the water supply pump in step 3.**

\* Make sure that the impeller is inside.

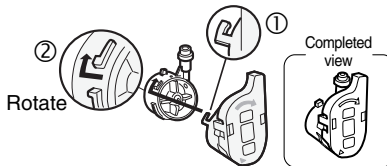

- 5. Set the water supply pump in step 4 onto the water tank by rotating it in the direction of the arrow.**

\* Align the triangle mark on the bottom of the water tank with the triangle mark on the filter and push in while making sure that there is no gap.

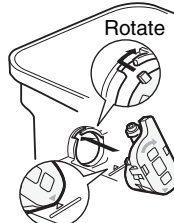

- 1. Insert the pipe into the water tank.**

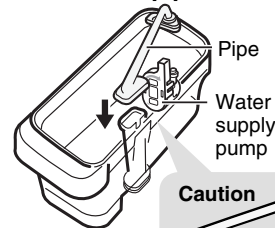

#### Caution

Do not let foreign objects block the hole.

- 2. Connect the pipe to the water supply pump.**

\* Check that there are no foreign objects between the pipe and the water supply pump.

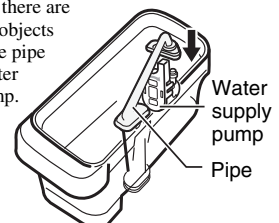

Before Use

Operation

Cleaning

Troubleshooting

# Removing and Cleaning the Parts

Before Use

Operation

Cleaning

Troubleshooting

## Step 1 Before cleaning

Remove the power plug



**Warning**  
Failure to unplug may result in an electric shock.

Wait at least 10 minutes before reinserting the power plug into the socket.  
If you insert the plug immediately, the mechanism will not function.

## Step 2 How to clean

- Wipe with a soft cloth soaked in warm water, or remove and rinse (Wipe the control panel with a soft, dry cloth.)
- For stubborn dirt, wipe using water mixed with a weak concentration of kitchen. In particular, be sure to wipe off oily dirt because leaving it may damage the



Do not use insecticide spray, alkaline or low alkaline kitchen powdered soap, alcohol, benzene, thinner, oil, acid, scrubbers, Doing so may cause the plastic parts (such as the door or damage or rust the doors or painted surfaces.

## Revolving Shelf

### Shelf removal

- ① Set the left and right levers to the "Lock" position.

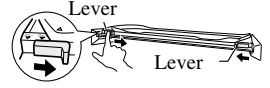

- ② Hold the front of the Revolving Shelf with both hands, and while slightly lifting up the rear, push the Revolving Shelf to the rear. (Guide the rear of the shelf to get on the left and right rails.)

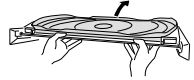

- ③ Lift the front of the Revolving Shelf, and remove from the refrigerator. (Pass it on the top of the left and right rails.)

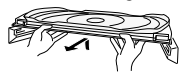

### Shelf installation

- ① Make sure that the levers are in the "Lock" position.

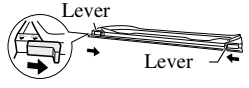

- ② Place the Revolving Shelf in the refrigerator, put it on the left and right rails, and pass it on the rails to the rear.

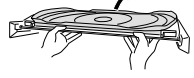

- ③ While passing the Revolving Shelf through the grooves of the left and right rails and pulling it to the front, lower the rear of the Revolving Shelf. (When pulling the Revolving Shelf to the front, make sure that it stops in the grooves of the rails.)

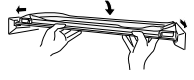

### Tray removal

- ① Set the lever to the "Lock" position.

- ② Hold the stopper knob in the middle of the Revolving Shelf, and remove the stopper by turning it in the direction of the arrow.

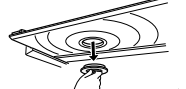
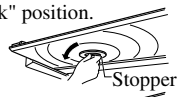

- ③ Insert your hand from the center of the Revolving Shelf, and lift up the tray.

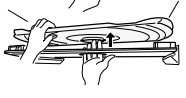

\*There is a risk of the tray falling. Move it slowly.

- ④ Pull out with both hands.

When installing the tray, position the tray in the direction shown in the figure. Installing in other directions will result in incorrect installation, and the part may fall out.

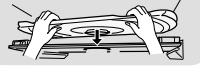

## AUTO Shelf (Do not disassemble the AUTO Shelf, or use chemicals such as grease to clean it. Doing so may cause a malfunction.)

### Shelf removal

- ① Move the lever to the right end.



- ② Strongly push up each support, one by one. (4 locations.) (A clicking sound is made when the support disengages.)

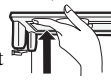

If the supports are firmly set and difficult to disengage, tilt the inner tabs to the inner side.

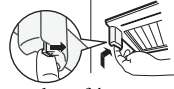

- ③ Remove from the refrigerator.



### Shelf installation

- ① Make sure that the lever is on the right side.



- ② Make sure that the 4 metal stoppers are fitted, and place the shelf lightly so that the 4 supports are aligned with the 4 metal stoppers.

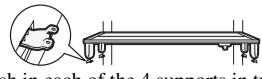

- ③ Push in each of the 4 supports in turn from above. (A clicking sound is made.)

- ④ Move the lever to the left and right and check that the AUTO Shelf is kept level when moved up and down. (If the shelf is not kept level, remove the AUTO Shelf and repeat steps ① to ④.)

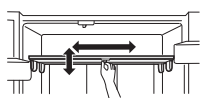

### Tray removal

- ① Push up the 3 tabs on the rear of the tray with your finger.

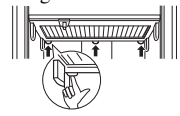

- ② Lift up the rear of the tray until the 3 front tabs and the 2 side tabs disengage.

\* There is a risk of the tray falling. Move it slowly.

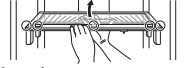

- ③ Pull out with both hands.

## Two-way flexishelf

Push in and lift up.

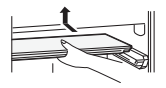

To return the parts, perform the removal procedures in reverse.

with water.

detergent (neutral).  
plastic parts.

detergents, scouring powder,  
boiling water, or similar substances.  
handles, caps and cases) to split,

### Step 3 After cleaning and periodically

#### Check the power plug and cord

For safety, clean periodically.

- ① Unplug the power plug from the socket and check it.
  - Check for damage or abnormal heating on the power plug and cord.
- ② Remove any dust from the power plug and surrounding area, and then wipe with a dry cloth.
- ③ Firmly insert the power plug into the socket.



**Warning**  
If the power plug or cord is damaged or dust accumulates, it may cause an electric shock or a fire.

#### Refrigerator rear and floor

- ① Remove the support cover.
- ② Turn the adjustable supports to raise them from the floor, and pull out the refrigerator. (We recommend laying out protective material on the floor to prevent the floor from being damaged. Also, be careful not to injure yourself.)
- ③ Remove the dust from the rear panels, walls and floor, and wipe off any dirt. (These areas are prone to buildup of dust and black dirt due to air convection. Clean them periodically. Doing so will also improve power efficiency.)
- ④ Check for water dripping on the floor.

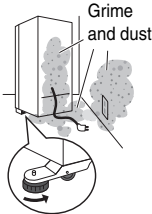

**Caution**  
Do not place your hands under the refrigerator. You may be injured.

#### Slide chilled case and small item case

- ① Fully pull out.
- ② Lift out to the front.

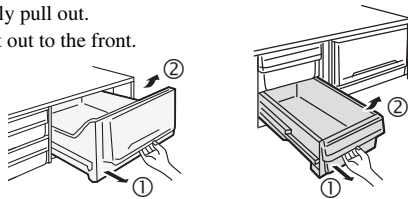

#### Adjustable pockets and bottle pockets



- ① Lift up the left and right alternately. (The pockets are firmly installed.)
- ② Pull out to the front.

#### When installing

- Make sure that the pockets are securely set. (Incorrect setting may cause a pocket to disengage and fall out, causing an injury.)

#### Ice making and versa compartments

- ① Fully pull out the door.
- ② Lift out to the front.

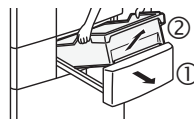

#### Drip gutters

Wipe off any dirt, dripping or condensation.

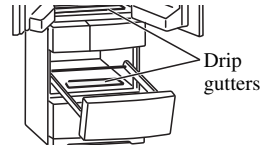

#### Freezer and vegetable compartments

Freezer compartment:  
Freezing case (upper)  
Vegetable compartment:  
Slide case

- ① Fully pull out.
- ② Lift out to the front.

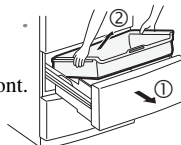

Freezer compartment:  
Freezing case (lower)  
Vegetable compartment:  
Vegetable case

- ③ Pull out while slightly lifting up the door, and then tilt.
- ④ Lift out to the front.

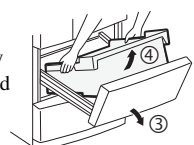





# Other Issues

Before Use

Operation

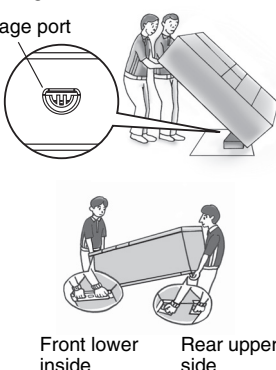
Cleaning

Troubleshooting

Issue	Action
A power outage occurs	<ul style="list-style-type: none"> <li>Minimize the frequency of opening the doors, and avoid adding more food.</li> <li>Control panel settings other than the temperature settings may change. Check the settings. (Child safety lock, fast cooling, supercool freezing, etc.)</li> </ul>
To move the refrigerator or change its orientation	<ol style="list-style-type: none"> <li>Raise the adjustable supports. ▶ <b>Page 7</b></li> <li>Lay protective material under the casters and rear supports to prevent floor damage.</li> <li>Move the refrigerator in the forward and backward directions.               <ul style="list-style-type: none"> <li>* Dragging in directions other than forward and backward may damage the floor.</li> </ul> </li> </ol>
When not using the refrigerator for a long time	<ol style="list-style-type: none"> <li>Clean the automatic ice maker. ▶ <b>Pages 25 - 26</b></li> <li>Unplug the power plug, clean the interior of the refrigerator, and open the doors for 2 to 3 days to dry the inside.               <ul style="list-style-type: none"> <li>* If the refrigerator is not dried sufficiently, it may cause mold, odors, or refrigerant (gas) leaks due to condenser corrosion.</li> </ul> </li> </ol>
To transport the refrigerator (when moving house, etc.)	<ol style="list-style-type: none"> <li>Empty any water or ice from the water tank and ice tray. ▶ <b>Pages 25 - 26</b></li> <li>Wear protective gear (gloves).</li> <li>Remove the support cover and raise the adjustable supports.</li> <li>Unplug the power plug.</li> <li>Lay towels under the drainage port and the lower rear edge of the refrigerator, and position a container or tray with a height of about 3 cm on the towels to collect the water.               <ul style="list-style-type: none"> <li>* The towels prevent floor damage, and water from being spilled on the floor.</li> </ul> </li> <li>Tilt the refrigerator slowly to the rear by about 30 degrees, and drain the water from the evaporation tray via the drainage port on the lower rear side. (The evaporation tray is not visible from the outside.)               <ul style="list-style-type: none"> <li>* Because the refrigerator is heavy, the work must be performed by at least 2 people.</li> <li>* The work must not be performed by small children or people who are not capable of doing heavy work. Ask a specialist transportation company.</li> </ul> </li> <li>2 or more people should hold the hand-holds on the lower inside of the front and the upper side of the rear, and carry the refrigerator slowly.               <ul style="list-style-type: none"> <li>Do not lay down the refrigerator on its side. (The compressor may be damaged.)</li> <li>When moving house, the frequency does not need changing. (Can be used with both 50 and 60 Hz.)</li> </ul> </li> </ol> <div style="border: 1px solid black; padding: 5px; margin-top: 10px;"> <p><b>⚠ Warning</b>  <b>Do not damage the refrigerant circuit, because it contains a combustible refrigerant. If the refrigerant (gas) leaks, it may cause a fire or explosion.</b></p> </div> <div style="text-align: right; margin-top: 10px;">  <p>Drainage port</p> <p>Front lower inside      Rear upper side</p> </div>
To set the freezer compartment to a lower temperature	<ol style="list-style-type: none"> <li>Repeatedly press <b>ROOM</b> to display FZR.</li> <li>Press <b>SELECT</b> and <b>ICE SELECT</b> at the same time for about 3 seconds. (Until the buzzer sounds twice.)</li> <li>Press <b>SELECT</b> to set <b>H</b>. <b>To cancel</b> Set the temperature control display of the freezer compartment to a setting other than <b>H</b>, or perform step ②.               <ul style="list-style-type: none"> <li>When the refrigerator is set to temperature fine adjustment mode and the temperature control display of the freezer compartment is set to <b>H</b>, the temperature of the freezer compartment can be set lower.</li> </ul> </li> </ol> <div style="text-align: right; margin-top: 10px;">  <p>"FZR" blinks about once every 10 seconds</p> </div>
<p><b>Demonstration operation status</b></p> <p>When the entire display blinks 3 times at a certain interval even though you have not operated any buttons</p> <p>When the compartment displays and temperature control displays on the control panel blink in order</p> <div style="text-align: center;">  </div>	<ul style="list-style-type: none"> <li>The refrigerator does not cool in this mode. Contact the retail store where you purchased the refrigerator, or cancel the demonstration operation with the procedure below.</li> </ul> <div style="border: 1px solid gray; border-radius: 10px; padding: 5px; text-align: center; margin: 10px 0;"> <b>To cancel the demonstration operation</b> </div> <ol style="list-style-type: none"> <li>Keep the doors of the refrigerator compartment open.</li> <li>Press <b>ROOM</b> twice.</li> <li>Press <b>SELECT</b>, <b>SUPERCOOL</b> and <b>ICE SELECT</b> at the same time for about 5 seconds.</li> <li>Make sure that there is no blinking of the display area for after a minute. (If the display still blinks, the demonstration operation has not been canceled.)</li> </ol>
When the  blinks rapidly (about 5 times per second) or the alarm cannot be turned off	<p>Contact the retail store where you purchased the refrigerator as soon as possible. Alternatively, contact MITSUBISHI SERVICE CENTER.</p> <ul style="list-style-type: none"> <li>Press the <b>ICE SELECT</b> button for about 5 seconds to stop the alarm. An inspection is required. Contact the retail store where you purchased the refrigerator or a Mitsubishi Electric Maintenance Service or Customer Service representative.</li> </ul>

When the refrigerator compartment, freezer compartment, or versa compartment (with the temperature control set to "FZR") is selected, you can control the temperature more precisely.

- When temperature fine adjustment mode is set, the compartment display blinks about every 10 seconds.

**Setting the temperature fine adjustment mode**

Press **SELECT** and **ICE SELECT** at the same time for about 3 seconds. (Until the buzzer sounds twice.)

To cancel The same operation as above.

**Performing the temperature fine adjustment**

ROOM

① Press **SELECT** to display the compartment for which you want to perform fine temperature adjustment.

② Repeatedly press **SELECT** to perform fine adjustment of the temperature.

Example: To set the refrigerator compartment 0.6°C lower than the low setting

"REF" blinks once about every 10 seconds

"H" blinks

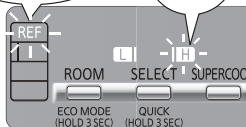

\* The values on the right are approximate. The temperature may differ from the values on the right, depending on factors such as the food storage condition and how often the doors are opened.

This represents a blinking display.

Note 1: The temperature of **H** freezer compartment setting in temperature fine adjustment mode is lower than when the refrigerator is not in temperature fine adjustment mode.

	Refrigerator or freezer compartment	Versa compartment (freezer setting)
	Low setting ▶ <b>Page 12</b>	About -12°C ▶ <b>Page 14</b>
	About 0.3°C lower than "L"	About 0.6°C lower than "L"
	About 0.6°C lower than "L"	About 1.2°C lower than "L"
	Low medium setting ▶ <b>Page 12</b>	About 1.2°C higher than "M"
	About 0.3°C higher than "M"	About 0.6°C higher than "M"
	Medium setting ▶ <b>Page 12</b>	About -15°C ▶ <b>Page 14</b>
	About 0.3°C lower than "M"	About 0.6°C lower than "M"
	Medium high setting ▶ <b>Page 12</b>	About 1.2°C lower than "M"
	About 0.6°C higher than "H"	About 1.8°C lower than "M"
	About 0.3°C higher than "H"	About 2.4°C lower than "M"
	High setting Note 1: ▶ <b>Page 12</b>	About -18°C ▶ <b>Page 14</b>

To control the temperature more precisely (Temperature fine adjustment mode)

# Specifications

This appliance is designed for use in Australia, New Zealand only and can not be used in any other country. No servicing is available outside of Australia, New Zealand.

	Food storage compartment type	Gross volume (litres)	Storage volume (litres)
Refrigerator compartment	Fresh food	317	279
Ice making compartment	Short term frozen food	24	7
Versa compartment	Short term frozen food	46	23
Freezer compartment	Freezer	137	79
Vegetable compartment	Special (unfrozen food)	113	72
	Total volume	637	460

	Parts	Quantity
Refrigerator compartment	Revolving Shelf	1
	AUTO Shelf	1
	Two-way flexishelf	1
	Slide chilled case	1
	Water tank (With optical catalyst and lead-cleaning filter)	1
	Adjustable pocket (large)	2
	Adjustable pocket (small)	2
Ice making compartment	Small item case	2
	Egg Shelf	1
	Bottle pocket (large)	1
	Bottle pocket (small)	1
	Ice tray	1
Versa Compartment	Ice storage box	1
	Soundproof mat	1
	Ice server	1
Freezer compartment	Versa case	1
	Aluminum tray	1
Vegetable compartment	Freezing case (upper)	1
	Freezing case (lower)	1
Vegetable compartment	Vegetable case	1
	Slide case	1
	Support cover	1

# Troubleshooting

First, check the items described in this section. If the problem persists, contact the retail store where you purchased the refrigerator as soon as possible.

Frequently asked questions in the initial period and in summer

Questions about operation and handling

## The refrigerator does not cool at all!

- The refrigerator takes time to cool when you first start using it. In the summer, it may take up to 24 hours for the inside to be fully cooled.
- Are the displays on the control panel blinking?  
→ Demonstration operation: ▶ **Page 30**
- Is the power plug disconnected or has the circuit breaker tripped?

## The outer walls heat up!

- The outer walls heat up significantly (to about 50 to 60°C) immediately after installation and in the summer. This is because the heat discharging and condensation prevention pipes are located on the sides and the top of the refrigerator. They are required for cooling and the heat is not an abnormality.
- The refrigerator compartment rotating partition also has a condensation prevention heater that heats up. ▶ **Page 6**
- A heat discharging fan is located under the refrigerator. Warm air may be discharged from here.

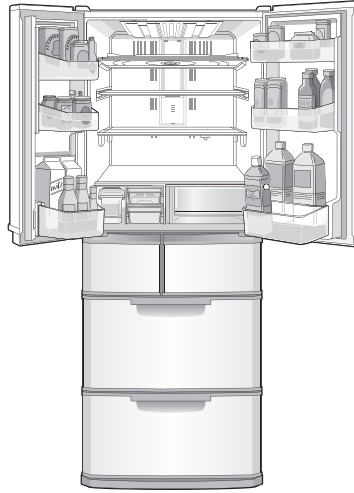

## The control panel turns off automatically!

- To save power, the display goes off if there is no operation for about 30 seconds. ▶ **Page 10**

## Strong odors on the food or ice!

- Do you clean the water tank once a week? ▶ **Page 26**
- Have you placed food with strong odors inside the refrigerator without sealing in a container? ▶ **Page 20**

### Problem

### Check

### Explanation and action

<p>Does not cool well Not much ice is made Ice melts</p>	<p>① Is "L" set as the temperature for the compartment? ② Has enough time passed after installation?</p> <p>③ Is heat discharging being blocked? Check there is gap around the refrigerator and the refrigerator is not exposed to direct sunlight. ④ Is the flow of cold air being blocked? Are the doors being opened frequently, or is a door ajar?</p>	<p>① Set the temperature to "M" or "H". ② It takes about 4 to 5 hours for the refrigerator to cool, and up to about 24 hours in the summer to make ice. ③ Check that the refrigerator is installed correctly. ▶ <b>Page 6</b></p> <p>④ Check the quantity of food inside and ajar door. ▶ <b>Pages 18, 22-23</b></p>
<p>Cannot make ice Water in the tank stays at the same level</p>	<p>① Has enough time passed after installation?</p> <p>② Is the ice tray installed correctly? Has <b>ICETRAY</b> turned on?</p> <p>③ Are the water supply pump and pipe installed correctly onto the water tank? ④ Is the water supply pipe installed correctly in the tank holder area? ⑤ Has food, the ice server or other object been left in the ice storage box?</p> <p>⑥ Is the ice making setting on the control panel for the ice making compartment set to "STOP"? ⑦ Is there enough water in the water tank? Is the refrigerator tilted?</p>	<p>① It takes about 4 to 5 hours after first starting operation for the refrigerator to cool, and up to about 24 hours in the summer to make ice. ② Set the ice tray lock lever to the correct position. ▶ <b>Page 26</b></p> <p>③ In particular, ensure that the opening of the pipe inside the tank is installed firmly to the tank. ▶ <b>Page 27</b> ④ Check. ▶ <b>Page 26</b></p> <p>⑤ The ice storage box is judged to be full of ice. Remove food or other objects from the ice storage box. Also, spread the ice out flat all the way to the front. ⑥ Set to "REG" or "QCK".</p> <p>⑦ The number of ice cubes in one batch may be reduced. ▶ <b>Page 25</b></p>
<p>Food freezes in compartments other than the freezer</p>	<p>① Is the temperature on the control panel set to "H"? ② Is food with a lot of moisture stored at the rear of the shelf? ③ Is the surrounding temperature 5°C or less?</p> <p>④ Is the water supply pipe installed correctly?</p>	<p>① Set the temperature to "M". Note that in the fast cooling operation, the temperature inside the refrigerator drops temporarily. ② Place drinks and food containing a lot of moisture, such as tofu, vegetables and fruit, at the front. ③ Freezing is likely to be prevented when the temperature settings of the refrigerator compartment and vegetable compartment are set to "L". ④ When the installation is incorrect or a gap is caused by a foreign object, the cold air may flow in reverse and cause food in the refrigerator compartment to freeze.</p>
<p>Food in the versa compartment melts</p>	<p>① Has enough time passed after temperature adjustment or installation? ② Is food stuck up in the upper area? ③ Did the hot food make contact with other food? ④ Did you press the SUPERCOOL button after placing hot food inside? ⑤ Was ice cream or frozen food stored with the "FZR" "L" or "FZR" "M" setting?</p>	<p>① The refrigerator takes time to cool completely. Wait 30 minutes before placing food inside, or use fast cooling. ② Leave a gap in the upper area so that the cold air can flow. ③ Frozen food may thaw if it makes contact with hot food. ④ Press the SUPERCOOL button after placing hot food inside. The food temperature will drop quickly. ⑤ Set to "FZR" "H".</p>



Problem	Check	Explanation and action
Cannot adjust the temperature	① Is  displayed?	① Cancel the child safety lock. <b>▶ Page 19</b>
Cannot perform supercool freezing (lamp does not light up)	① Is the compartment display “VR” and the temperature setting display “SOFT FZR”?	① Change the setting of the versa compartment to soft freezing, and then press the SUPERCOOL button. Supercool freezing is only available when the versa compartment is set to soft freezing. <b>▶ Page 15</b>
Supercool frozen food does not taste good	① Did you press the SUPERCOOL button? ② Is the food that you want to supercool freeze on top inside the versa compartment, without overlapping? ③ Has enough time passed after changing the versa compartment fo “SOFT FZR”?	① Press the SUPERCOOL button. Check that the supercool freezing indicator is displayed. ② The food temperature is measured with the HIKARI sensor. Lay out the food for supercool freezing flat and on top in the versa compartment. <b>▶ Page 17</b> ③ Set to soft freezing, and when the temperature has stabilized (after about 2 hours), perform supercool freezing. <b>▶ Page 15</b>
Condensation forms on the outer walls and inside the refrigerator Frost forms in the freezer compartment Water drips onto the floor	① Are the doors being opened frequently, or is a door ajar? ② Is the humidity high, for example is it raining?	① When moisture in the air cools, it forms frost or condensation. Even when a door is open only slightly, it can cause frost or condensation, or dripping onto the floor. <b>▶ Page 18</b> ② Condensation may form temporarily. Wipe off with a dry cloth. It is also easy for frost to form in the freezer compartment. Minimize the time that the doors are open.
Doors open easily Doors do not close	① Is a door making contact with food or a case? Is too much food packed inside? ② Has food fallen behind a case in a drawer door, or is the power cord or another object trapped between the refrigerator and a door? ③ Is the refrigerator installed stably? Are the adjustable supports making contact with the floor?	① Store food so that the door does not make contact with objects when closed. ② Remove any objects. Make sure that the door does not trap objects such as food, power cords or plastic bags. ③ Lower the adjustable supports to raise the front side slightly and make the doors easier to close. <b>▶ Page 7</b>
Door alarm sounds	① Is the door of the refrigerator, ice making or freezer compartments open? ② Is the rotating partition of the refrigerator compartment open to the front?	① Close the door. The alarm sounds at every minute after the door is opened, and after 4 minutes it sounds continuously. If the alarm sounds even after closing the door, press the ICE SELECT button for about 5 seconds to stop it. An inspection is required. Contact the retail store where you purchased the refrigerator. <b>▶ Pages 11, 30</b> ② Check the position of the rotating partition while the doors are open.
Ice is small or joined together	① Has ice been stored inside for a long time?	① If the ice is stored for a long time, ice cubes may join together or shrink. (Due to a phenomenon called sublimation.)
Water tank or water supply pipe freezes	① Is the water supply pipe installed firmly in the water tank? Is there a foreign object between the water tank and the water supply pipe? ② Has food, a plastic bag or another object fallen behind the case in the ice making compartment or freezer compartment?	① When the installation is incorrect or a gap is caused by a foreign object, the cold air may flow in reverse and cause freezing. <b>▶ Page 26</b> ② The cold air may flow in reverse and cause freezing. Remove any objects.
Water tank or water supply pipe is warm	This is because of the anti-freeze heater. It is not an abnormality.	
Noise interferes with televisions or other devices	① Is the refrigerator installed near to an electronic device such as a television? ② Is the power to the refrigerator supplied from a socket near the entry hole of the antenna cable?	① Install the refrigerator away from electronic devices such as televisions. ② We recommend using a separate, grounded power supply.

# Troubleshooting (Continued)

Problem	Check	Explanation and action
<p>Loud noises Annoying noise (These noises are normal.)</p>	<ul style="list-style-type: none"> <li>① The noise gets louder suddenly or the tone changes.</li> <li>② A rattling or squeaking sound is made sometimes (every 1 to 2 hours).</li> <li>③ After turning on the power, a thumping or creaking sound is made sometimes in the ice making "STOP" mode (every 1 to 2 hours).</li> <li>④ A whistling sound is made after closing a door.</li> <li>⑤ A hissing, bubbling or running water sound is made sometimes.</li> <li>⑥ A whipping or dripping sound is sometimes heard from inside the refrigerator after a door is opened.</li> <li>⑦ A buzzing sound is made sometimes.</li> <li>⑧ A low whirring sound is made after opening the freezer compartment door.</li> </ul>	<ul style="list-style-type: none"> <li>① Immediately after installation, when the weather is hot, when the doors are frequently opened and closed, during the fast cooling operation, and in similar situations, the refrigerator switches to high-speed operation and cools with high power.</li> <li>② This is the sound of the automatic ice maker. Even when there is no water in the water tank, the automatic ice maker and pump make a sound about every 100 minutes.</li> <li>③ This is the sound of the automatic ice maker's operation check. The check is performed even in the "STOP" ice making mode.</li> <li>④ This is the sound of the fan motor starting.</li> <li>⑤ This is the sound of the refrigerant (gas) flowing.</li> <li>⑥ This is the creaking sound as warm air enters and expands the plastic.</li> <li>⑦ This is the operating sound of the damper as it adjusts the air flow.</li> <li>⑧ This is the sound of air blowing through the cooling fan.</li> </ul>
<p>Blue LED in the versa compartment does not turn on</p>	<p>While the versa compartment is open, open the door of the refrigerator compartment and check that the blue LED inside the versa compartment turns on. If the LED turns on, there is no abnormality.</p>	<p style="text-align: right;">▶ Page 22</p>

Before Use

Operation

Cleaning

Troubleshooting

# Memo

- This refrigerator uses flammable foaming gas for insulation.  
Please deliver the unit to specialized industrial waste dealer when you do away it.  
Please follow the rules in your country.
- **WARNING** - Do not use mechanical devices or other means to accelerate the defrosting process, other than those recommended by the manufacturer.
- **WARNING** - Do not use electrical appliances inside the food storage compartments of the appliance, unless they are of the type recommended by the manufacturer.
- **WARNING** - Just in case of having damaged the refrigerant circuit, do not use electric items or fire equipments near by, and open the window to ventilate the room. And contact the retail store at which you purchased it or the following **MITSUBISHI SERVICE CENTER**.
- The refrigerator contains flammable refrigerant (R600a: iso-butane).
- The refrigeration system behind and inside the refrigerator contains refrigerant.  
Do not allow any sharp objects to come into contact with the refrigeration system.
- Do not block the openings on the circumstances of the refrigerator.
- The user manual should be handed over to any person who would use or handle the refrigerator whenever the refrigerator would be transferred to another location and delivered to a recycling plant.
- The appliance is not intended for use by young children or infirm persons without supervision.
- Young children should be supervised to ensure that they do not play with the appliance.

### **R600 a Refrigerant Warning**

- This appliance contains a small quantity of R600a refrigerant which is flammable.
- During transportation and installation, ensure that the tubing of the refrigerant circuit is not damaged.
- Leaking refrigerant can ignite and may damage the eyes.
- In the event any damage does occur, avoid exposure to open fires and any device which creates a spark.  
Disconnect the appliance from the mains power.
- Thoroughly ventilate the room in which the appliance is located for several minutes.
- Notify Mitsubishi Electric Australia Pty Ltd. for necessary action and advice.
- The room for installing the appliance must be at least 1 cubic metre per 8 grams of refrigerant.  
The refrigerant quantity contained in this appliance is noted on the Rating Plate of the appliance.
- If your Mitsubishi Electric Refrigerator should require service, please contact Mitsubishi Electric Australia Pty Ltd see back page of this user manual for contact details.

**NOTE: MITSUBISHI ELECTRIC AUSTRALIA PTY LTD. DO NOT ALLOW SERVICE TO THE REFRIGERATION CIRCUIT OF THIS APPLIANCE.**



#### **SOLE AGENT in Australia**

#### **MITSUBISHI ELECTRIC AUSTRALIA PTY LTD.**

(Incorporated in New South Wales) ABN 58 001 215 792

#### **New South Wales:**

348 Victoria Road, Rydalmere NSW 2116 Ph: (02) 9684 7777, Fax: (02) 9898 0484

#### **Queensland:**

Unit 12, 469 Nudgee Road, Hendra QLD 4011 Ph: (07) 3623 2000, Fax: (07) 3630 1888

#### **South Australia / Northern Territory:**

Suite 1, 224 Glen Osmond Road, FULLARTON SA 5063 Ph: (08) 8338 1001, Fax: (08) 8338 0501

#### **Western Australia:**

Unit 5, 329 Collier Road, Bassendean WA 6054 Ph: (08) 9377 3400, Fax: (08) 9377 3499

#### **Victoria / Tasmania:**

Suite 28, 270 Ferntree Gully Road, Notting Hill VIC 3168 Ph: (03) 9535 7800, Fax: (03) 9535 7801

#### **SOLE AGENT in New Zealand**

#### **BLACK DIAMOND TECHNOLOGIES LIMITED (BDT)**

#### **Wellington Office (Head Office)**

1 Parliament Street PO Box 30-772 Lower Hutt Ph: (04) 560 9100, Fax: (04) 560 9133

#### **Auckland Office**

Unit 1, 4 Walls Road Penrose Auckland PO Box 12-726 Ph: (09) 526 9340, Fax: (09) 526 9369

#### **Christchurch Office**

Suite 2, Level 1, 37 Mandeville Street Christchurch PO Box 1604 Ph: (03) 341 7052, Fax: (03) 341 7054