

MITSUBISHI ELECTRIC

MITSUBISHI ELECTRIC DEHUMIDIFIER

MODEL

MJ-E102NX-A1

MJ-E142NX-A1

INSTRUCTION MANUAL

Features

- 16 litres per day
(MJ-E102NX-A1)
- 20 litres per day
(MJ-E142NX-A1)
- Powerful dehumidifying
Swing Louvre
- Quick dehumidifying
- Simple operation
LCD panel

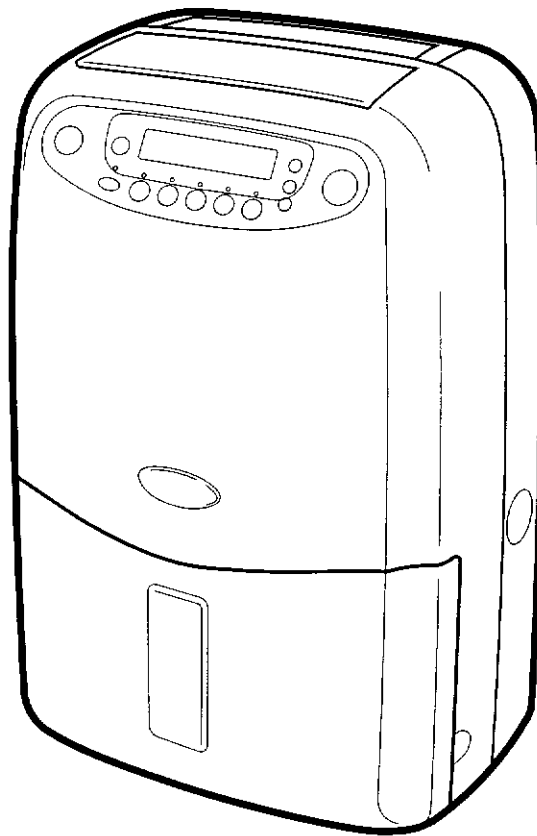

- In order to ensure correct usage, please read this instruction manual carefully and retain it for future reference.
- Before accepting the Warranty at the time of purchase, please make sure that the date of purchase, place of purchase and other items are correctly filled in the form.



Protecting our environment
and enriching our lives by
saving energy

Various ways of using your dehumidifier

To dry your laundry



Set the swing louvre towards the laundry and you will be able to dry it quickly.

To remove moisture from closets and other enclosed spaces.

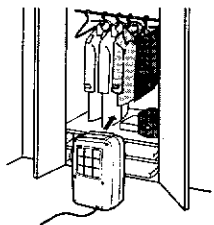

To prevent condensation.



To use your dehumidifier efficiently

When the operation noise is too loud

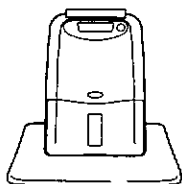

Place a mat etc. under the unit in order to reduce vibrations and noise.
(It will also minimize uneven areas of flooring, carpets etc.)

About installing your dehumidifier

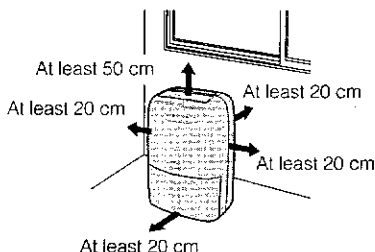

Less space will reduce efficiency but will not warm the unit.

To prolong the service life of the odour/air cleaning filter



If not using the filter for a long period of time, place it in a plastic bag, seal it tightly, and store it.

How your dehumidifier works

If you pour cold water into a cup, the air around gets cold causing water drops to form on the surface of the cup. The dehumidifier takes advantage of this phenomenon to remove moisture.

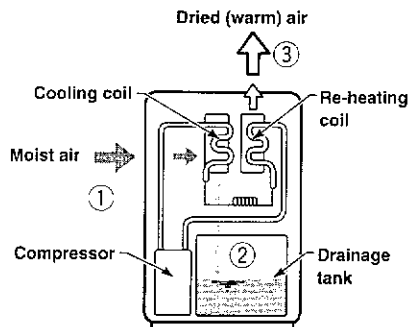

- ① The unit sucks in the room air, cools the air down with its cooling coil, then transforms moisture into water drops.
 - ② The water drops fall into the drainage tank.
 - ③ The dehumidified air is re-heated by the heating coil, and then discharged.
- Your room's humidity is thus removed by repetition of steps ①, ②, and ③.

To protect your musical instruments which are vulnerable to humidity

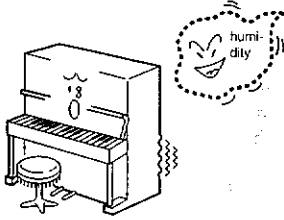

Relationship between dehumidification and room temperature/humidity

The lower the temperature and humidity, the smaller is the quantity of dehumidifying as shown on the graph.

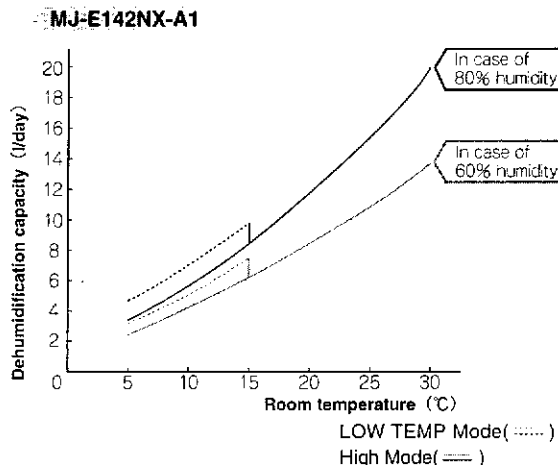
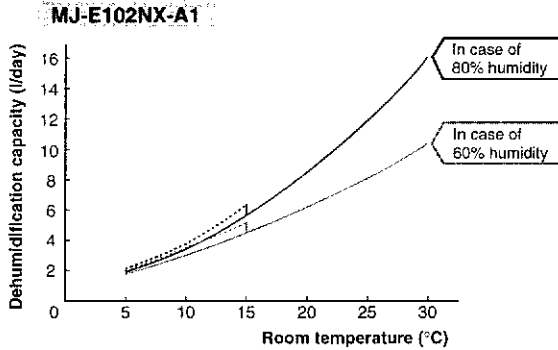

The dehumidification quantity values shown on the graph were measured at constant temperature and humidity, and do not reflect the actual usage conditions.

Table of Contents

| | Page |
|--------------------------------------|------|
| Precautions..... | 4 |
| Names and functions of parts..... | 8 |
| Before using your dehumidifier | 9 |

Operating

| | |
|--|----|
| Turning the unit on and off | 10 |
| Switching between operation modes | 11 |
| Setting the movement of the louvre | 12 |
| Defrosting operation "DEF", Tank Full lamp, Cold lamp..... | 13 |
| High Humidity warning..... | 14 |
| Child Lock | 14 |
| Using the timer..... | 15 |
| Removing water from the tank | 17 |
| Continuous drainage of water | 18 |
| Moving the unit (on castors)..... | 19 |

| | |
|-----------------------|----|
| Maintenance..... | 19 |
| Storage | 21 |
| Troubleshooting | 22 |

| | |
|---------------------|------------|
| Specifications..... | Back cover |
|---------------------|------------|

Before using the unit



Operating

Trouble-shooting





Precautions

- Make sure to read the precautions below before using your dehumidifier and apply them when using the unit.

Dangerous situations which can be caused by mishandling of the unit are categorized and explained below.

| | |
|---|---|
|  WARNING | <p>Mishandling may result in fatal or serious injuries.</p> |
|  CAUTION | <p>Mishandling may result in injuries or damage to your property, e.g. your room, equipment, etc.</p> |

Meaning of the graphic symbols used in this manual and on the unit is explained below.

| | |
|---|---|
|  | <p>Indicates an action forbidden under any circumstances.</p> |
|  | <p>Keep the unit away from fire.</p> |
|  | <p>Do not disassemble, repair, or modify under any circumstances.</p> |
|  | <p>Do not subject to water under any circumstances.</p> |
|  | <p>Always follow the instructions.</p> |

WARNING

Use power points which meet the rated standards of 220V — 240V AC.

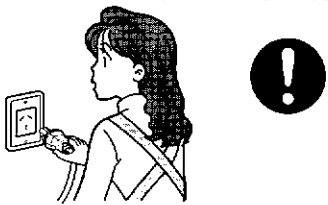

Using at a voltage other than 220V — 240V may cause fire and/or electric shock.

Use a suitable extension cord for the related power capacity.

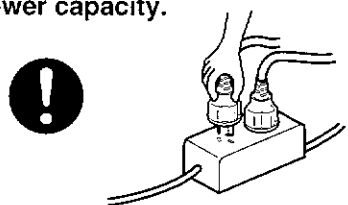

Such actions can result in electric shock and/or fire.

Wipe dust off the power plug and insert the plug firmly.

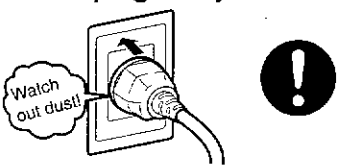

If the plug is not fully inserted in the socket, dust may gather on the connectors which in turn may cause fire and/or electric shock.

Do not damage or modify the power cord.

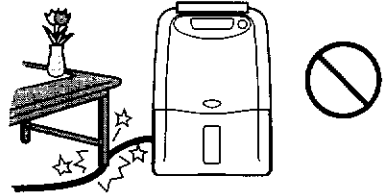

Do not place heavy objects on the power cord, apply heat to it, or stretch it, as this can damage the cord and result in fire and/or electric shock.

Never connect multiple units to one outlet.

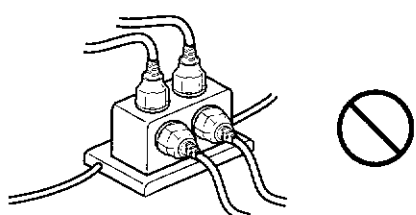

This may result in electric shock and/or generation of heat.

Do not start or stop the unit by plugging and unplugging the power cord.

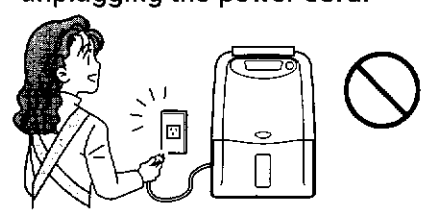

This may result in fire and/or electric shock.

⚠ WARNING

Do not set the unit near heat-generating devices (such as stoves, fan heaters, etc.).

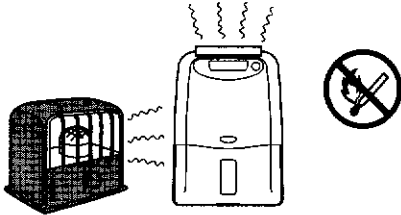

The plastic parts may melt **causing fire**.

Should a malfunction occur (a smell of burning, etc.), switch off the unit and unplug it from the socket.

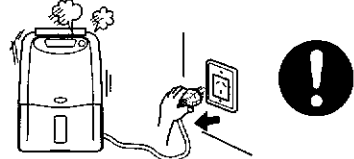

Continuing to operate a malfunctioning unit may result in **fire, electric shock, and further malfunction**. Contact your dealer or Mitsubishi Electric Repair Service Station for consultation.

Before using
the unit

Do not put your fingers or any objects into the air outlet or inlet. Do not touch the louvre.

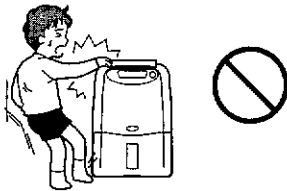

The internal fan rotates at a high speed, and thus such an action may result in an **injury or malfunction**.

Do not attempt to repair, take apart, or modify the unit.

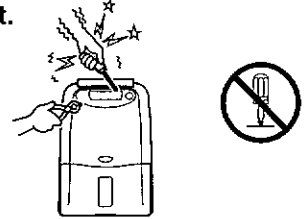

It may result in **fire and/or electric shock**. Refer servicing to your dealer or Mitsubishi Electric Repair Service Station.

Remove water that has collected in the tank.

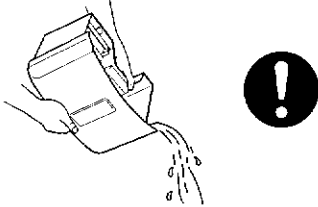

Accidental drinking of the water or using it for other purposes may cause **illness and/or unforeseen accidents**.

⚠ CAUTION

Install the unit in a location where the floor is stable and strong.

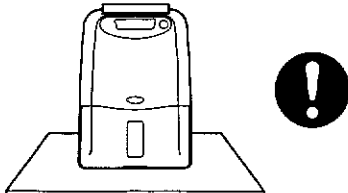

If the unit falls over, the water collected in the drainage tank may leak thus damaging surrounding objects (carpet, furniture, etc.) and in turn result in **fire or electric shock** caused by a leak of electricity.

Do not use the unit in places that may be subject to oil or flammable gas leakage.

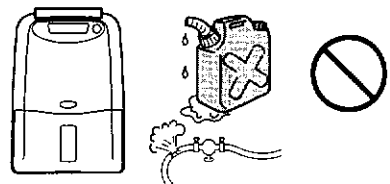

Such a leakage around the unit may cause **combustion and fire**.

Precautions

- The appliance is not intended for use by young children or infirm persons without supervision;
- Young children should be supervised to ensure that they do not play with the appliance.

CAUTION

Do not use the unit in narrow, enclosed places such as inside closets, between pieces of furniture, etc.

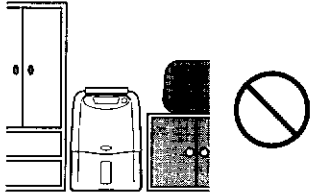

This results in poor ventilation and may cause **heat generation and/or fire**.

Do not use the unit for special purposes such as preservation etc. of food, art works, scientific works, etc.

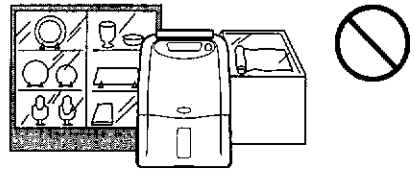

This may deteriorate the quality of the items stored.

Do not use the unit where it is likely to come in contact with water.

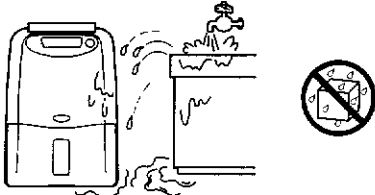

Exposure to water may result in **fire or electric shock** caused by a leak of electricity.

Do not cover the air inlet and the air outlet on the back of the unit with cloth, curtain, etc.

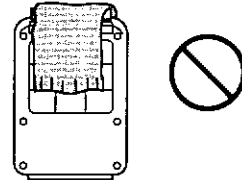

This results in poor ventilation and may cause **heat generation and fire**.

Do not use the unit where it may be exposed to direct sunlight or weather. (This unit is for indoor use only.)

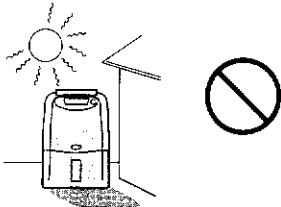

This may cause **overheating, electric shock and/or fire by short-circuiting**, or plastic discolouration.

Do not set on the dehumidifier flower vases or any other objects filled with water.

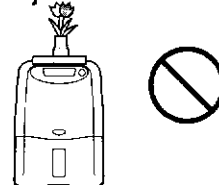

Water may leak into the unit adversely affecting the electric insulation and cause **electric shock and/or fire by short-circuiting**.

Do not use the unit in places subject to chemicals (in hospitals, factories, laboratories, beauty salons, etc.).

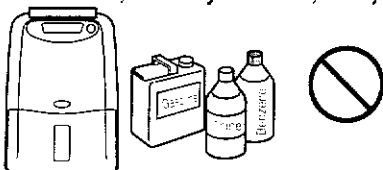

Drugs and solvents evaporated in the air may negatively affect the unit and cause **the tank water to leak**.

Do not sit or stand on the unit.

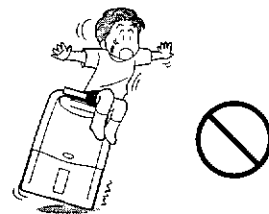

The unit which stands on castors may move and fall over, **resulting in an injury**.

⚠ CAUTION

Before moving the unit always switch it off and remove water from the drainage tank.

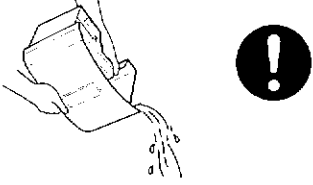

Moving the unit with water in its tank may cause the water to leak and damage the surrounding objects (carpet, furniture, etc.) and in turn result in electric shock and/or a leak of electricity.

Do not remove the Styrofoam from the floating element.

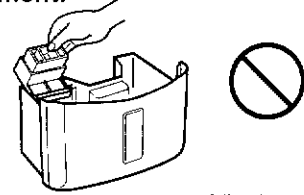

The floating element will not be able to detect full tank resulting in water leakage which may damage the surrounding objects (carpet, furniture, etc.), cause electric shock and/or leakage of electricity.

Before moving the unit, empty the drainage tank, then firmly grasp the handle and move the unit on its castors.



Otherwise the unit may fall over and cause an injury or damage the floor.

Unplug the unit from the power source when not using the unit for an extended period of time.

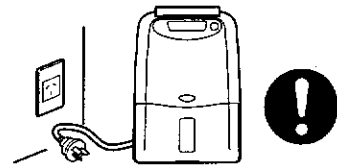

Otherwise it may cause fire or electric shock.

Do not pull on the power cord when disconnecting it from a socket. Do not use the cord when it is bundled.

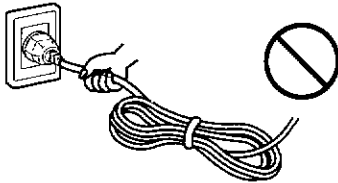

This may result in heat generation and fire.

In case of continuous drainage make sure to set the hose so that the water is drained without obstruction.

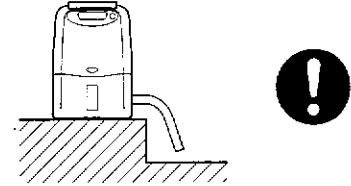

The water in the tank may leak and damage the surrounding objects (carpet, furniture, etc.).

Switch the unit off and unplug from the power source when cleaning it.

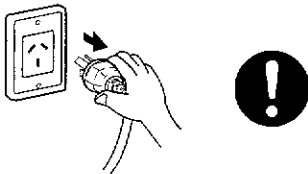

When on, the internal fan rotates at a high speed and may cause an injury.

Do not drain water continuously if there is a possibility that temperature around the hose could drop to freezing point.



Water inside the hose may freeze and prevent the water in the drainage tank from flowing out. The water may leak from the unit and damage the surrounding objects (carpet, furniture, etc.).

Do not wash the unit with water.

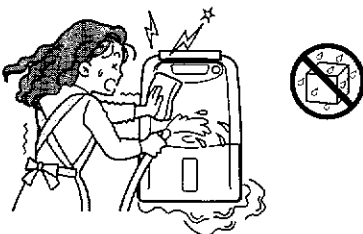

It may cause an electric shock.

When using the unit after it has been stored for an extended period of time, or when draining water continuously with no assistance, inspect the hose periodically to make sure that there are no foreign objects in it that could clog it. Otherwise, it may result in a water leakage and/or heat generation.

Use the unit with caution in rooms where the walls and furniture are vulnerable to dry air as it may cause cracks and warping.

Before using
the unit

Names and Functions of Parts

Front

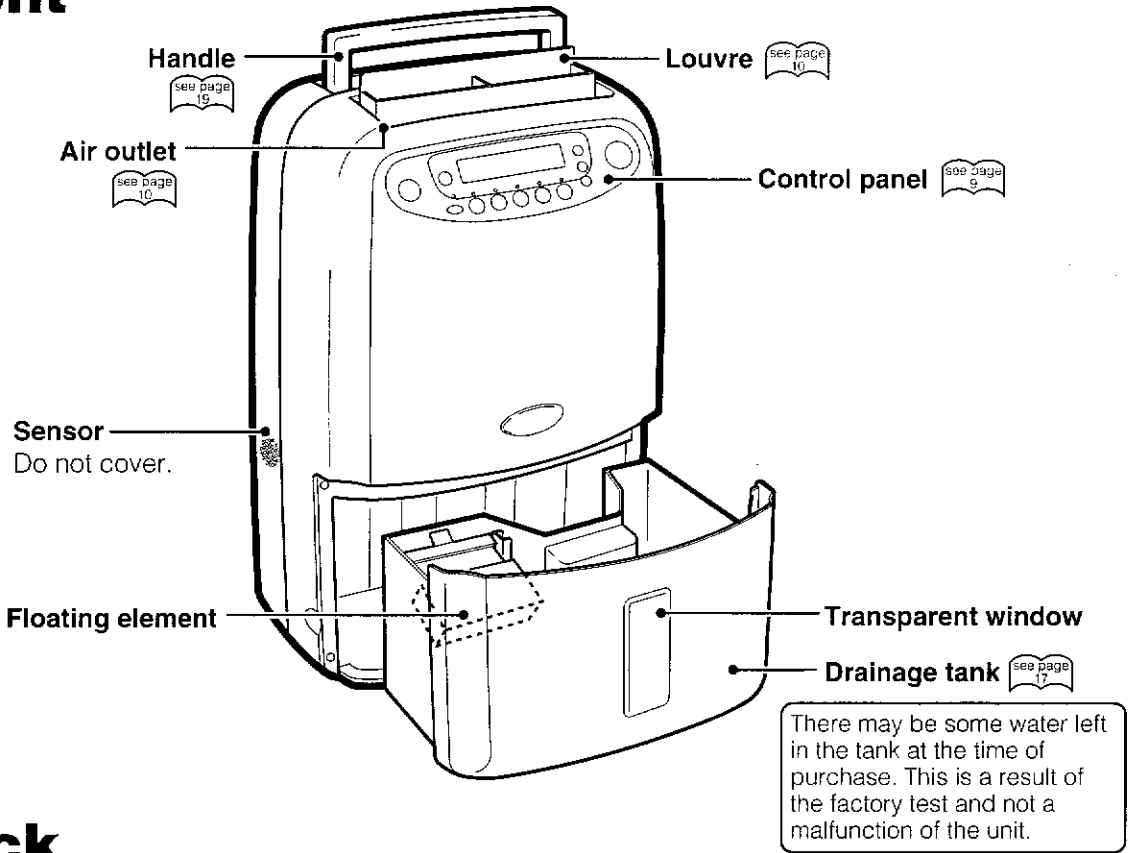

Back

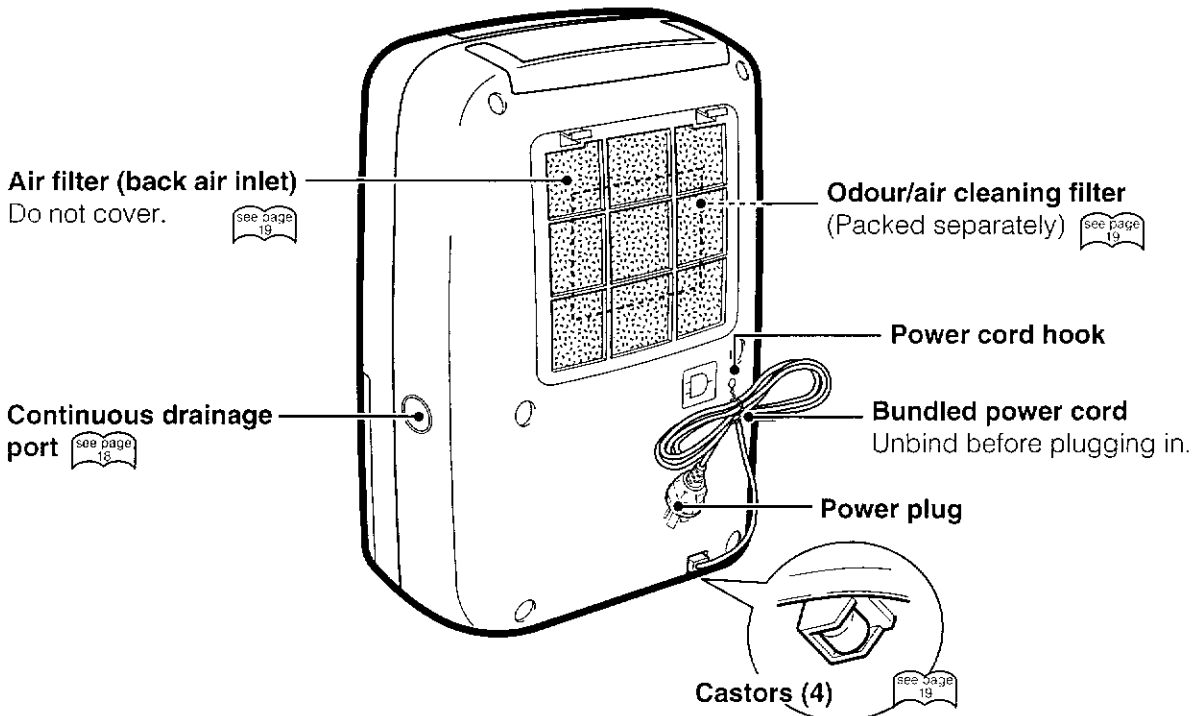

Control panel

For explanatory purposes, all indications on the liquid crystal display are shown simultaneously.

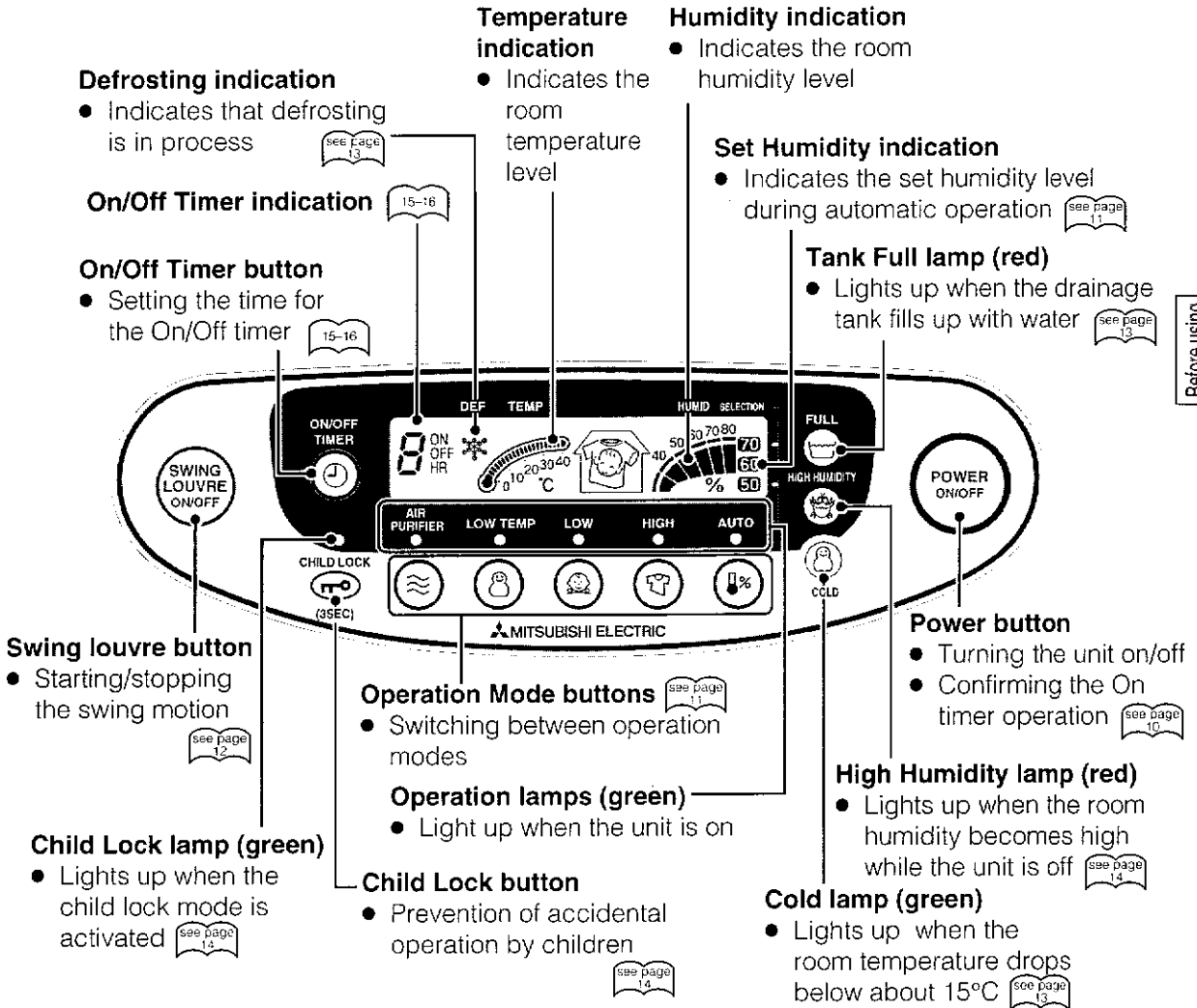

Before Using Your Dehumidifier

1 Install the odour/air cleaning filter in the air filter

- To attach follow steps 1, 4, and 5 of "Cleaning the Air Filter". (See page 19)

2 Make sure that the drainage tank is installed properly.

- Push in the tank with both hands.

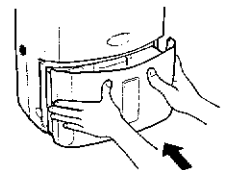

Note

- When using on a carpet, the unit's castors may leave marks. Spread a mat etc. under the unit.

Turning the Unit On and Off

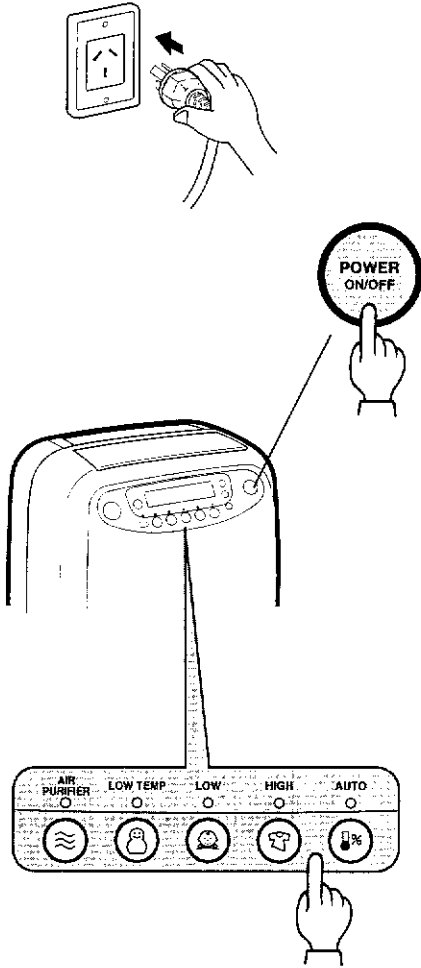

1 Connect the power plug to a power socket (220 — 240 V AC)

2 Press the Power button.

- The louvre opens automatically.
- The operation lamps light up.
- Dehumidification begins.
(After unplugging, then re-plugging, the automatic operation runs at the 60% level.)
- If the Tank Full lamp is on, first make sure to empty the tank before turning the unit on.

In order to protect the compressor, dehumidifying does not occur for about 3 minutes after turning unit on. When dehumidifying begins the operational noise increases.

3 Switch between the different operation modes.

- A lamp indicates the selected operation mode

Press the Swing Louvre button in order to activate the louvre, or to stop it at a desired angle. (Each time the button is pressed, the swing movement goes on or off.)



To stop

Press the Power button again.

- The louvre closes automatically
- The operation lamp goes off
- Dehumidification stops



Note

- Dehumidification should be carried out in temperature ranging from 1°C to 40°C. Using the unit in temperature outside the range will overload the unit resulting in improper operation. (The compressor stops in temperature equal to or lower than 1°C, while operating the unit in temperature of 35°C or higher will trigger the safety device resulting in a steady air flow and causing intermissions in the operation.)
- This dehumidifier has **no cooler function**. In fact it emits some heat causing the room temperature to rise by 2 to 4°C.

Switching Between Operation Modes

Press the desired operation mode button.

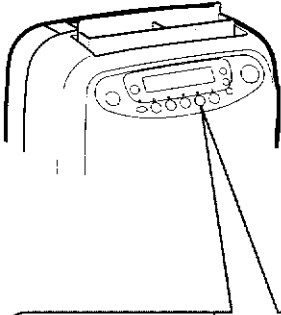

- The selected operation mode lamp and the AIR PURIFIER lamp light up.

The air purifying function operates in all the modes, therefore it is always indicated.

After unplugging, then re-plugging the unit, the automatic operation runs at the 60% level. With the plug remaining connected, the operation switches to the previously selected mode.

| Operation Mode buttons | Sample of indication | Purpose |
|---|------------------------------------|--|
| <p>AUTO</p> <p>Each time the button is pressed</p> | <p>When humidity is set to 60%</p> | <p>To maintain a comfortable level of humidity</p> <ul style="list-style-type: none"> • The unit maintains the set humidity by controlling the air flow strength (LOW ↔ MIDDLE). • Dehumidification is switched on for 15 minutes after turning on the unit regardless the humidity level in the room. • When the humidity in the room decreases below the set level, the unit stops to dehumidify and swing the louvre. (If humidity increases, the operation goes on again. When the operation is stopped, the Swing Louvre button does not work.) |
| <p>HIGH</p> | | <p>To dry clothes etc. (The effect can be enhanced by setting the louvre to swing.)</p> <ul style="list-style-type: none"> • The air flow quantity is continuously at the "HIGH" level. |
| <p>LOW</p> | | <p>For dehumidifying with lower operation noise.</p> <ul style="list-style-type: none"> • The air flow quantity is continuously at the "LOW" level. |
| <p>LOW TEMP</p> | | <p>To help prevent moisture condensation, when temperature in the room is low.</p> <ul style="list-style-type: none"> • The air flow quantity is automatically set to and kept at the "HIGH"/"VERY HIGH" level. If temperature in the room is below 15°C (Cold lamp is on), the unit is set to "VERY HIGH". |
| <p>AIR PURIFIER</p> | | <p>To decrease cigarette smoke, pollen, or other impurities in the air.</p> <ul style="list-style-type: none"> • The air is cleaned by passing it through the odour/air cleaning filter. Dehumidification is off. |

Note

● Operation noise may remain unchanged after switching from AUTO mode to LOW mode. This happens when the air flow quantity is already low in the AUTO mode.

Setting the Movement of the Louvre

The unit allows you to set the louvre to the swing mode and change the angle at which the air blows. The air blowing noise changes depending on the blowing direction. If it is too noisy, set the louvre vertically.

CAUTION



Do not put your fingers or any objects into the air outlet or inlet. Do not touch the louvre.

The internal fan rotates at a high speed, and thus such an action may result in an injury or malfunction.

To set the louvre to the swing mode

Press the Swing Louvre button

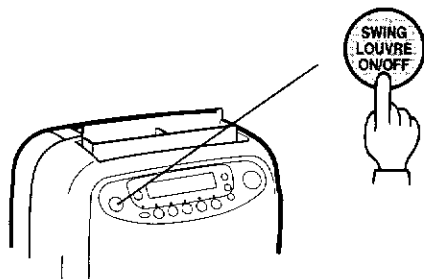

- The louvre begins to swing

At times the louvre stops for a short while in order to adjust its positioning, however it immediately restarts to move.

Should you happen to touch the louvre with your hand or some other object and as a result change the louvre's swinging angle, first stop the louvre's swinging movement, then restart the swinging movement.

If you switch off the unit with the Swing Louvre button set to "ON", next time the unit is turned on, the switch will remain "ON".

To stop the louvre

Press the Swing Louvre button again.

- The louvre stops



To stop the louvre at a desired angle

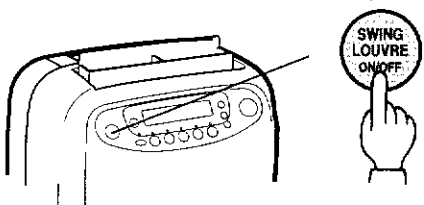

1 Press the Swing Louvre button.

- The louvre begins to move

2 Press the Swing Louvre button when the louvre is in a position you want it to stop.

- The louvre stops

Should angle of the louvre change for some reason, repeat the steps above to readjust.



Defrosting operation "DEF"

Sometimes it may happen that, while the unit is on, the * mark will appear, then the fan will stop to blow followed by a change in the operation noise. This is not a malfunction. It is caused by the self-defrosting mode which is activated automatically by the unit in order to remove frost from the unit's inside. Should it happen, please allow the unit a while to perform the procedure. After defrosting is completed, the unit will switch back to the original operation mode.

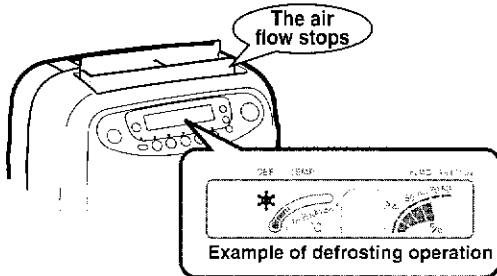

- * appears
- The air flow stops (the louvre remains open)
- The operation noise changes

When temperature in the room falls below 15°C, the unit performs the operation once every 30 minutes (at the most) for 5 minutes a time.

In the defrosting mode, the louvre stops to swing, and the Swing Louvre button cannot be switched on/off. After defrosting is completed, the louvre begins to swing again.

Tank Full lamp

When the drainage tank fills up with water (about 5.5 litres), the unit stops automatically, and the Tank Full lamp lights up. Refer to "Removing the water" to remove the water from the tank.

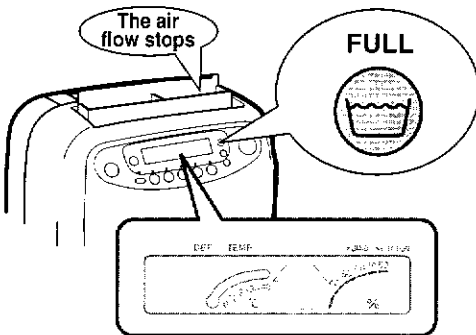

- The FULL lamp lights up
- The temperature and humidity indications disappear
- The operation lamps go off
- The air flow stops (but the louvre remains open)

After having removed the water and reattached the tank, the FULL lamp will go off, and the unit will automatically re-enter the operation mode.

When the tank is full, the unit cannot be switched to other operation modes. The louvre also stops to swing, and the Swing Louvre button cannot be switched on/off. Only after having removed the water, the louvre starts to swing again.

Cold lamp

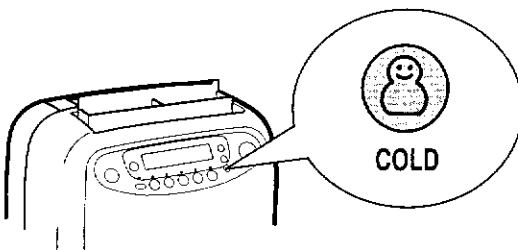

The lamp lights up if the room temperature drops below 15°C when the unit is on. By setting the LOW TEMP mode on when the lamp is lit, the dehumidifying efficiency increases. This way it is possible to maintain higher dehumidifying efficiency in low temperature.

High humidity warning

When humidity in the room increases while the Power button is "OFF" (the unit must be plugged in), the unit's sensor detects high humidity automatically, and indicates it by turning the HIGH HUMIDITY lamp on. This feature can be helpful to find out when dehumidifying is necessary.

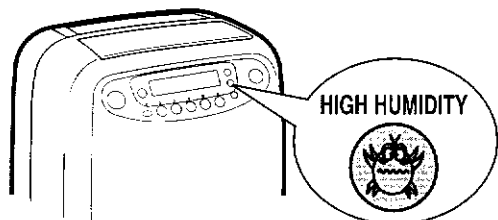

- The HIGH HUMIDITY lamp lights up in case of excessive humidity (approx. 75% or higher).

To begin dehumidifying, press the Power button to "ON". When the HIGH HUMIDITY feature is not to be used, pull out the power plug from the power point.

Child Lock

By activating child lock, it is possible to prevent children from accidental operation of this unit.

Press the Child Lock button for over 3 seconds.

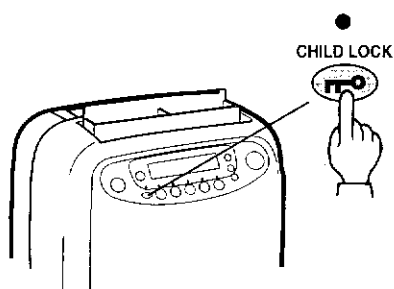

- The Child Lock lamp lights up.

With the lock activated, it is only possible to switch the lock on/off. All other controls do not function.

If the lock function has been activated with the power button off, pressing the power button does not switch the unit on. In this case only the Child Lock lamp blinks.

With the child lock set on while the unit is on, pressing the power button to switch the unit off does not switch the unit off. In this case only the Child Lock lamp blinks.

Perform all operations only after having deactivated the child lock function.

To deactivate child lock

Press the Child Lock button for over 3 seconds.

- The Child Lock lamp goes off.



Using the Timer

The Off Timer and On Timer cannot be set simultaneously.

Off Timer operation

The timer can be set for 1 to 9 hours (in 1 hour steps). Make sure to set the timer only after having removed water from the drainage tank.

- 1 Make sure that the unit is operating.**
- 2 Set the desired operation mode.** SEE PAGE 11
 - The selected operation lamp lights up.
- 3 Set the movement of the louvre.** SEE PAGE 12
- 4 Press the Timer button. Set the desired time after which the unit should go off.**

- Press once to indicate “/” “HR OFF”.
- Each time the button is pressed, the indication changes from 1 to 9. (The indication will change automatically by holding the button pressed for a while).
→ The Off Timer setting is completed.

- The remaining time to switch off the unit decreases by 1 every hour.
- When the set time comes, the unit turns off and the louvre automatically closes.

To cancel the Off Timer

Press the Timer button until the remaining time disappears. (The unit goes back to continuous operation.)

- The Off Timer is canceled.

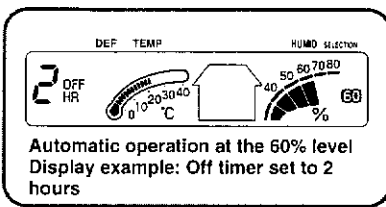
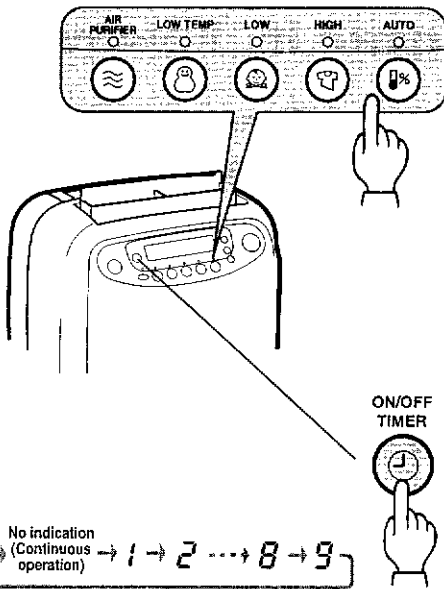

Note

Should the drainage tank fill up with water while in the timer operation mode, the FULL lamp will light up and the unit will stop. When the set time passes, all indications disappear and the unit stops to operate.

The On Timer mode does not function on timer-sockets.

On Timer operation

The timer can be set for 1 to 9 hours (in 1 hour steps). Set the timer after having removed water from the drainage tank.

The louvre will move as it did when last used.

1 Make sure that the unit is not in operation (it must be plugged in, however).

2 Press the Timer button. Set the desired time.

- Press once to indicate “/” “ON”. The operation lamp blinks.
- Each time the button is pressed, the time increases 1 hour.

3 Set the desired operation mode. see page 1

- The selected operation lamp blinks.

4 Press the Power button.

- The remaining time, “ON”, and the operation lamp blink → light up
→ The On Timer setting is completed

In order not to forget to press the power button, the set time and the operation lamp blink as a reminder to press the button.

- The remaining time to switch on the unit decreases by 1 every hour.
- When the set time comes, the unit turns on.

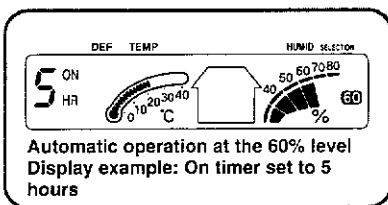
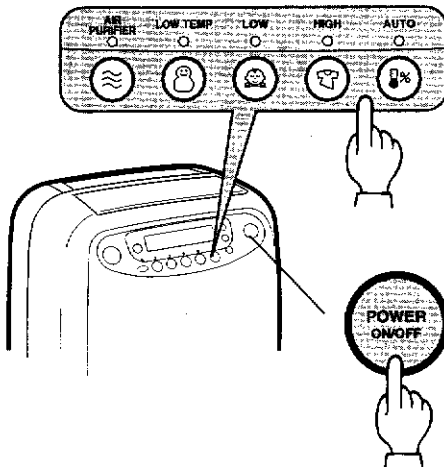
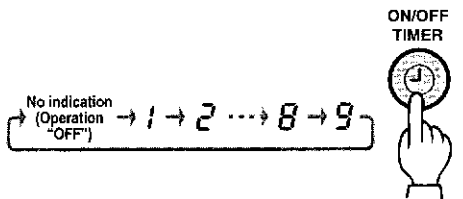

To cancel the On Timer

Press the Power button.

- Cancellation of the On Timer (The “HR ON” indication, remaining time to turn on the unit, and operation lamp all go off).

Removing Water from the Tank

When the drainage tank becomes full (about 5.5 litres), the unit automatically stops, and the Tank Full lamp lights up . Remove water from the tank.

1 Remove the drainage tank.

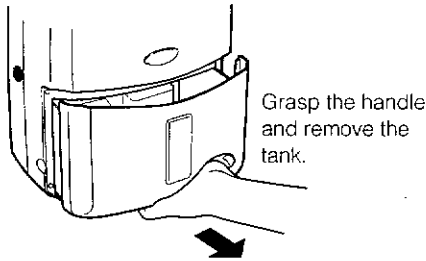
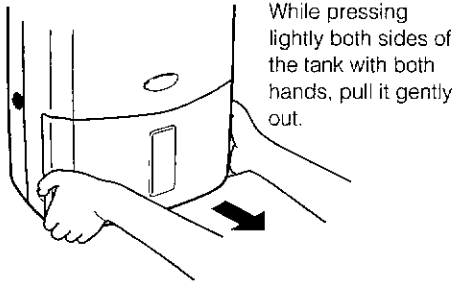

Hold the tank this way.

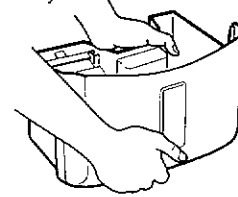

CAUTION



Do not remove the Styrofoam from the floating element.

The floating element will not be able to detect full tank resulting in water leakage which may damage the surrounding objects (carpet, furniture, etc.), cause electric shock and/or leakage of electricity.

2 Pour out the water.

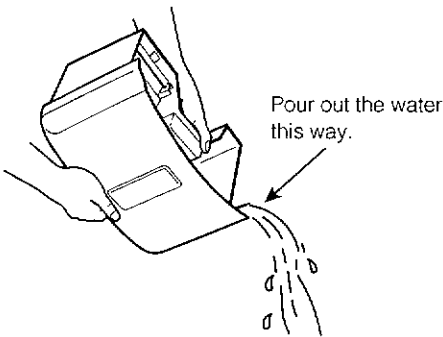

Should the drainage tank become dirty, wash it with cold or lukewarm water, then wipe with a dry cloth. If the inside of the tank is blackened (with dust in the air), dry the tank first and then wipe the dirt with a dry cloth. (Do not use detergents, polishing powders, chemically treated dustcloths, gasoline, benzene, thinner, or other solvents, as they can scratch and damage the tank and cause water to leak.)

3 Set the tank back in its place.

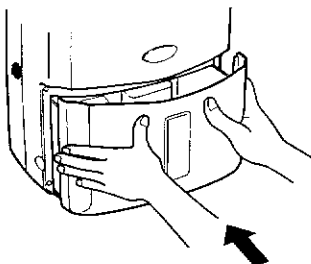

Firmly push the tank into place with both hands. If the tank is set incorrectly, the tank full sensor is activated and the unit cannot be switched on.

Operating

Continuous drainage of water

If there is a place nearby where water can be disposed into, the water in the drainage tank can be drained continuously through a commercially available hose (with the inside diameter of 15 mm). When setting up the equipment, always switch the unit off and unplug it from the power source.

⚠ CAUTION



Do not drain water continuously if there is a possibility that temperature around the hose could drop to freezing point.
Water inside the hose may freeze and prevent the water in the drainage tank from flowing out. The water may leak and **damage the surrounding objects (carpet, furniture, etc.).**



When using the unit after it has been stored for a while, or when draining water continuously with no assistance, inspect the hose periodically to make sure that there are no foreign objects in it which could clog it.
Otherwise, it may result in a **water leakage and/or heat generation.**

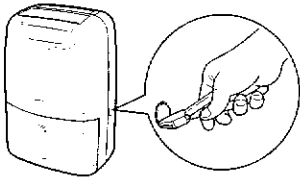

1 Remove the drainage tank, then open the continuous drainage port.

Use nippers to cut three fixing ribs of the continuous drainage port on the side of the main unit, then remove it carefully making sure that it does not fall inside the unit.

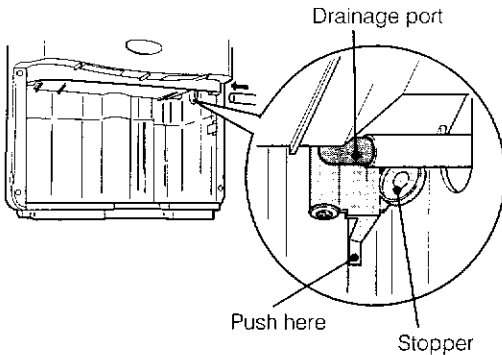

2 Insert the hose into the continuous drainage port.

While pushing the stopper, put a commercially available hose (with the inside diameter of 15 mm) through the continuous drainage port hole, then push it firmly onto the drainage port, and make sure that water does not leak.

How to fix the drainage hose

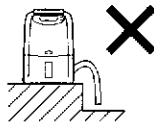
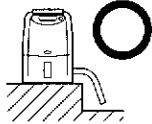

If any point of the hose is bent up, the unit's tank full detector will activate, and subsequently stop the unit making the continuous drainage operation impossible. It may also cause water leakage and/or electric shock.

3 Set the tank back in its place.

Check the hose periodically to make sure that it is firmly connected to the port and has not deteriorated.

Moving the Unit (On Castors)

1 Pour out the water.

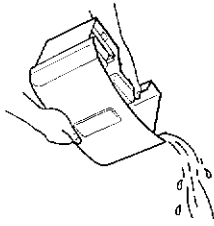

2 Lift up the handle.

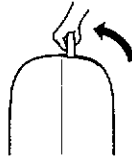

3 Move the unit.



- Note**
- Before moving the unit, make sure to **remove water from the tank** in order to prevent water from leaking. see page 17
 - If using on a floor that can be easily scratched or is uneven, **lift the unit up to move it**. Also, **avoid rolling the unit on castors** on a shaggy carpet. This can damage the surface of the carpet.

Maintenance

Never perform any maintenance work when the unit is plugged in.

Cleaning the air filter

The air filter should be cleaned approximately once every two weeks. Filter covered with dust, etc. will cause deterioration of dehumidifying.

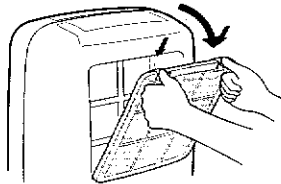

1 Remove the air filter.

To remove press downwards the tabs on the filter. Even if the metal fin inside the main unit is slightly bent, it does not affect its performance.

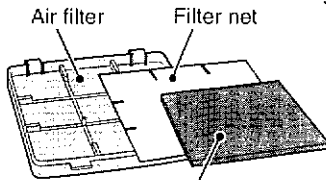

The odour/air filter cannot be washed.

2 Remove the odour/air purifying filter.

3 Clean the air filter and the filter net.

Run a vacuum cleaner lightly over the air filter surface to remove the dirt.

- If the air filter is very dirty, wash it with a lukewarm mild detergent solution, then dry it thoroughly.
- If the filter net is very dirty, remove it from the air filter, then clean with a vacuum cleaner.

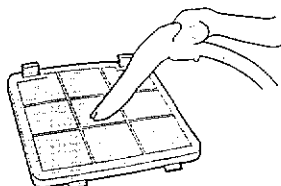

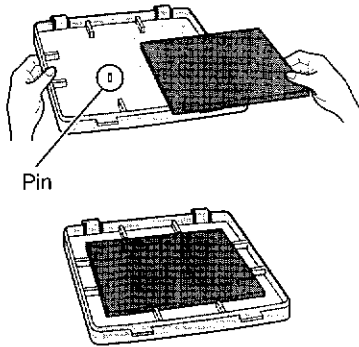

4 Set the filter net and odour/air filter back in the air filter.

With the green side facing outwards, set the filter in the center of the air filter, then press around the area of the two pins to press the pins into the filter.

If the white side (the reverse side) of the odour/air purifying filter turns brown or black, the filter should be replaced.

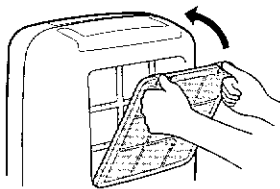

5 Attach the air filter.

Insert the lower tabs into the main unit, then press the air filter until the tabs click into place.

Replacing the odour/air purifying filter

Remove the air filter, following the instructions of “Cleaning the Air Filter”, then replace the odour/air purifying filter.

The odour/air purifying filter is disposable.

The filter's service life varies depending on the location in which the dehumidifier is used. If the white side of the filter turns brown from cigarette smoke, or black from dust, the filter should be replaced.

- Continuing to use the dehumidifier with a dirty odour/air purifying filter may cause odour and may result in the unit being unable to remove moisture from the air.
- An odour/air purifying filter can't be washed in water.

Parts sold separately

Odour/air purifying filter for replacement

Type: MJPR-NXFT
Part Number: M495C5808

Available at your nearest Mitsubishi Electric Dealer
or by calling 04 560 9094 or spares@mclco.co.nz

Cleaning the Unit and the Drainage Tank

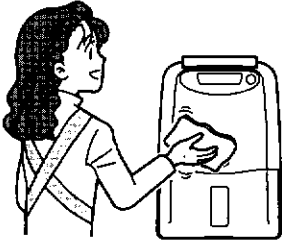

Use a soft cloth to wipe it.

Do not use gasoline, benzene, thinner, polishing powders, chemically treated dustcloths, detergents, or other solvents, as they can damage the unit.

Storage

When the unit is not to be used for an extended period of time

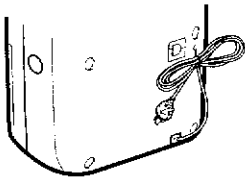

1 Bundle the power cord and attach it to the power cord hook.

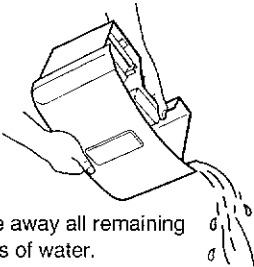

Wipe away all remaining drops of water.

2 Remove all the water left in the drainage tank. see page 17

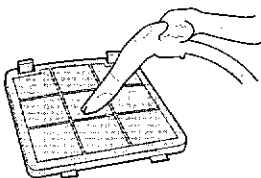

3 Clean the air filter. see page 18-20

Storing the odour/air purifying filter see page 2

Place the filter in a plastic bag, seal it tightly, and store it.

4 Store the unit.

When sure that all parts of the unit have dried, cover it with a cloth or similar material to keep it from dust, then store it in a location not exposed to direct sunlight.

Troubleshooting

● Should any of the SYMPTOMS listed below occur, check the CORRECTIVE ACTION column to locate and remedy the problem.

| SYMPTOM | POSSIBLE CAUSE | CORRECTIVE ACTION |
|---|--|--|
| The unit does not operate. | Power cord is not connected. | Plug the power cord to a power point. <small>see page 10</small> |
| | The Tank Full lamp lights up (the drainage tank is full). | Remove water from the drainage tank, then place the tank back in the unit. <small>see page 13&17</small> |
| | The drainage tank is not installed properly. | Remove water from the drainage tank, then properly place the tank back in the unit. <small>see page 17</small> |
| | Child Lock lamp blinks | Cancel the child lock mode. <small>see page 14</small> |
| Dehumidifying does not function. | Air filter is clogged. | Follow the instructions of "Maintenance". <small>see page 19-20</small> |
| | Air outlet and/or inlet are blocked. | Remove any object that may be blocking the air outlet and/or inlet. <small>see page 6</small> |
| No air being discharged. | Air filter is clogged. | Follow the instructions of "Maintenance". <small>see page 19-20</small> |
| Operation is noisy. | The unit is badly installed (it is tilted, unsteady). | Install the unit in a location where the floor is stable and strong. <small>see page 5</small> |
| | Air filter is clogged. | Follow the instructions of "Maintenance". <small>see page 19-20</small> |
| P2 is displayed. (Letters/digits are displayed alternately.) | Power plug is not firmly inserted in the socket. | Plug it in firmly. |
| P4 is displayed. (Letters/digits are displayed alternately.) | Something is sitting on the louvre, or the louvre is closed. | Remove any object from the louvre. Plug the power cord firmly in the socket. |
| ED-EB, A1, A6 are displayed. (Letters/digits are displayed alternately.) | Malfunction. | Unplug the unit from the power socket, then contact your dealer and inform them about the display contents. |

Should the problem persist or the Malfunction Display remain on after having checked the above list, turn off the unit with the Power button, unplug the power cord from the power point, and contact your dealer.

● The following SYMPTOMS do not indicate malfunction.

| SYMPTOM | CAUSE |
|---|---|
| The operation noise suddenly increases during use. | The operation noise increases when the compressor is activated (three minutes after the power button is turned on, or during automatic operation, or during defrost mode.). |
| The air is smelly at the beginning of operation. | This may happen for a while when temperature of the heat exchanger rapidly increases. |
| Air discharged is warm. | Before dehumidifying, the air is first cooled down, then re-heated, therefore the discharged air is warm. (The unit is not an air-conditioner.) <small>see page 2</small> |
| The room humidity does not reach the set level. | The room is too big. Windows and doors are opened too frequently. A gas heater which produces moisture is being used. |
| Low or no dehumidifying. | This may happen when the room temperature/humidity is low. (In winter, when the air is dry, humidity decreases, and dehumidification is almost impossible.) <small>see page 3</small> |
| No dehumidifying. No air discharged. Louvre does not swing (when its movement is activated). | Defrosting mode is on. The unit starts after the defrosting operation is finished. <small>see page 13</small> |
| | Automatic operation mode is on. Operation stops when the room humidity drops below the set level. <small>see page 1</small> |
| Louvre angle and/or movement is strange. | Press again the Swing louvre button. <small>see page 12</small> |
| Noise that accompanies the discharged air changes dramatically. | The noise changes dramatically depending on the louvre angle. |
| Operation noise reverberates. | It may happen when using the unit between pieces of furniture or in a narrow room. <small>see page 2</small> |
| Rumbling or other strange sounds are made by the unit when starting, stopping operation, or changing modes. | The refrigerant may be producing strange noises before its circulation stabilizes. |
| Compressor does not work. | To protect the compressor, it turns off immediately after stopping the unit to operate, or for three minutes after plugging in the power cord. |
| | The compressor is off when in the automatic operation mode the room humidity drops below the set level. |
| Fluid or white deposit left after evaporation can be found in the drainage tank. | This is the remainder of water which accumulated in the tank during the unit test run at the factory, and is not a malfunction. |

Trouble-shooting

Specifications

| | | |
|-------------------------------|--|------------------------|
| Model | MJ-E102NX-A1 | MJ-E142NX-A1 |
| Power supply | Single phase 220 — 240V 50Hz | |
| Dehumidifying capacity | 16.0 litres/day | 20.0 litres/day |
| Power consumption | 260W | 380W |
| Drainage tank capacity | 6.0 litres (stops automatically at about 5.5 L) | |
| Mass | 11.9 kg | 12.9 kg |
| Dimensions (h × w × d) | 567mm × 380mm × 269.5mm | |
| Accessories | Odour/air purifying filter | |

- Dehumidifying capacity is a value obtained when the dehumidifier was continuously run in a room with temperature of 30°C and humidity of 80%. It indicates the amount of dehumidification per one day (24 hours).

Distributed and guaranteed throughout New Zealand by:

MELCO NEW ZEALAND LTD.

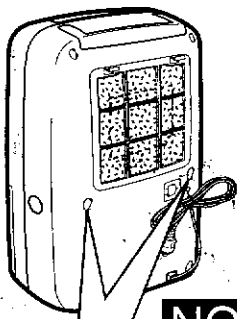

NOTE

It is impossible to remove the back panel because the two spots shown on the back figure are fastened with two special screws. When the unit is out of order, contact your Mitsubishi dealer:

Auckland

Unit 1, 4 Walls Rd.
PO Box 12726 Penrose
Auckland
Phone 09 5269340
Fax 09 5253116

Wellington

1 Parliament St.
PO Box 30772
Lower Hutt
Wellington
Phone 04 5609100
Fax 04 5609131

Christchurch

Unit 1, 3 Birmingham Dr.
PO Box 1604
Addington
Christchurch
Phone 03 3386591
Fax 03 3386491

Distributed throughout Australia by:

MITSUBISHI ELECTRIC AUSTRALIA PTY. LTD.

(INCORPORATED IN NEW SOUTH WALES)
A, C, N, 001 215 792

New South Wales

348 Victoria Rd.
Rydalmere 2116
Phone: (02) 96847777

Queensland

Unit 1, 104 Newmarket Rd.
Windsor 4030
Phone: (07) 33578877

Western Australia

329 Collier Rd.
Bassendean 6054
Phone: (08) 93773400

South Australia/ Northern Territory

77 Port Rd.
Hindmarsh 5007
Phone: (08) 83402000

Victoria/ Tasmania

Unit 4, 303 Burwood Hwy.
East Burwood 3151
Phone: (03) 92629855

Fill in the following for your future reference.

Place of purchase:

Telephone number:

Date of purchase:

Day

Month

Year