

MITSUBISHI ELECTRIC

MITSUBISHI DEHUMIDIFIER

MODEL MJ-80JWX-A1

INSTRUCTION MANUAL

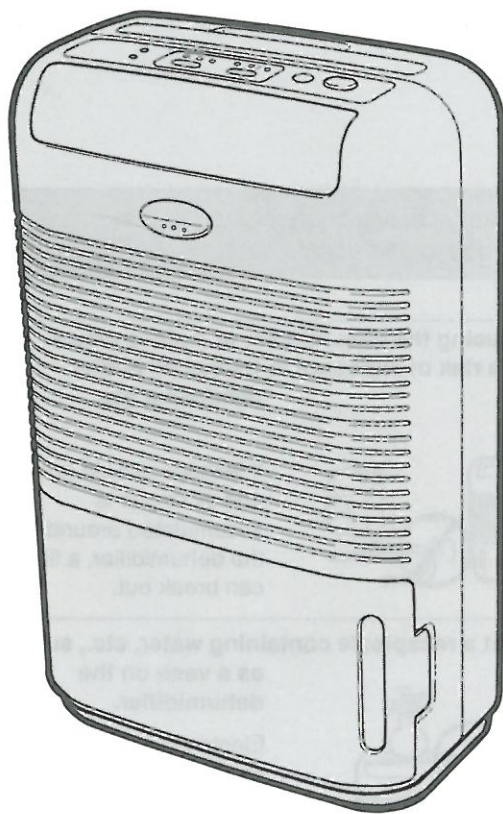

TABLE OF CONTENTS

BEFORE USE

Crucial points to be observed for safety	2
Main features of this dehumidifier	6
Points to be noted before operation	7
Names and functions of various component parts	8

HOW TO USE

Dehumidifying operation	10
Air-purifying operation	11
Timer operation	12
How to drain continuously	13

OTHER CASES

Operation and Performance	14
Smart ways to use	15
How to care	16
Specifications	17
Troubleshooting guide	18

- Read this instruction manual carefully before use for proper and safe operation. Thereafter, keep this manual for your occasional perusal.
- Fill out the Warranty Card making sure that the date of purchase and dealer name etc., are properly entered.

CRUCIAL POINTS TO BE

Read this chapter before use for proper and safe operation.

After reading, keep this manual at a place convenient for perusal by anyone before operation.

There are various levels of risk involved when operating this unit. They are divided into ⚠ warning and ⚠ caution symbols. The meaning of these symbols is explained in the table.

The meanings of symbols explained in this manual or on the main unit are as follows:

	Never attempt to do under any circumstances.
	Never put the dehumidifier near fire.
	Make sure to follow instructions.
	Exercise caution.

■ Points to be observed when placing the unit.



CAUTION

(Mishandling can result in bodily injury or lead to the damage of a house, household effects etc.).

Use the dehumidifier in a horizontal and sturdy place.

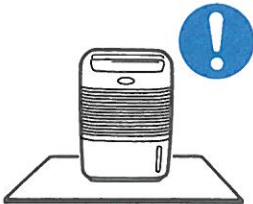

If the dehumidifier topples during operation, water inside the unit can leak, wetting household effects, etc., and can also result in electric shock, electric leakage and/or fire.

Avoid placing the dehumidifier at a place where there is a risk of exposure to leaked oil and/or flammable gas.



If leakage should occur and oil or gas is accumulated around the dehumidifier, a fire can break out.

Avoid the use of the dehumidifier in a closet and a narrow space between two pieces of furniture, etc.



Poor ventilation can result in heat generation and subsequent fire.

Never put a receptacle containing water, etc., such as a vase on the dehumidifier.



Electric insulation can be deteriorated by spilled and leaked water in the dehumidifier, resulting in electric leakage and/or fire.

Avoid using the dehumidifier in a place liable to be exposed to water splashing.

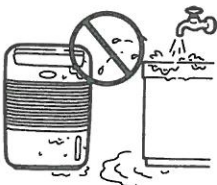

Contact with water can result in electric shock, electric leakage, and/or fire.

Avoid placing the dehumidifier at a place that is exposed to direct sunlight, wind, and rain. (This unit is for indoor use)

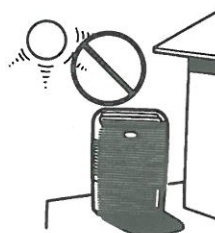

Such action can result in overheating, electric shock, electric leakage and fire.

OBSERVED FOR SAFETY

■ Points to be observed when placing the unit.



CAUTION

(Mishandling can result in bodily injury or lead to the damage of a house, household effects etc.).

Avoid using the dehumidifier for special applications such as the storage of food stuffs, art objects, scientific data, etc.



Such use can result in the quality deterioration of stored goods.

In case of continuous drainage, protect a hose from falling below freezing point.



Otherwise, water inside the hose can be frozen in the room, resulting in wet furniture, etc., due to the leakage of water accumulated by dehumidification.

In the case of continuous drainage, make sure that the drain hose is clear (not twisted or blocked).



Otherwise, water accumulated by dehumidification can leak in the room and wet the furniture.

Avoid the use of the dehumidifier at a place where drugs and chemicals are used or stored. (Hospitals, factories, laboratories, beauty parlors, etc.)

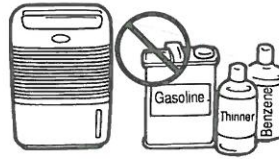

Drugs and solvents evaporated in the air can deteriorate the dehumidifier, and the water accumulated by dehumidification can leak out in the room and wet the furniture.

■ Points to be observed during operation.



WARNING

(Mishandling can result in bodily injury or lead to the damage of a house, household effects etc.).

Check for the presence of dust that may have adhered to the pins on the power plug. Insert the power plug completely into the outlet.



Dust on the power plug and a gap between the plug and the outlet or a loose connection between them can result in electric shock, and/or fire.

Do not insert your finger or a rod into the air outlet or air inlet.



A fan rotating at a high speed inside can cause injuries.

Do not use extension cords or multiple power outlets when connecting this unit to the power supply.

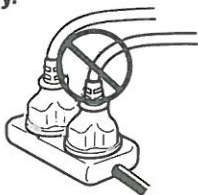

Such actions can result in electric shock, heat generation, and/or fire.

CRUCIAL POINTS TO BE

■ Points to be observed during operation.



WARNING

(Mishandling can result in bodily injury or lead to the damage of a house, household effects etc.).

Do not start or end the operation of the dehumidifier by inserting the power plug into the outlet or by pulling the power plug from the outlet.

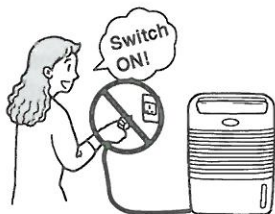

Such actions can result in electric shock and/or fire.

Do not place the dehumidifier near a heater.

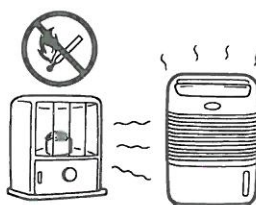

There is a risk that the coated resin can melt and catch fire.

Use only 230-240V AC power supply outlets when operating this unit.



The use of power outlets other than 230-240V AC can result in an electric shock and/or fire.

Do not damage the power cord or attempt to repair it if damage has occurred. Refer servicing to qualified personnel.



The power cord can be damaged if a heavy article is placed on it, or if it is heated, or tugged, resulting in electric shock and/or fire.

■ Points to be observed during operation.



CAUTION

(Mishandling can result in bodily injury or lead to the damage of a house, household effects etc.).

Do not pull the power plug from the outlet while holding the power cord in your hand.

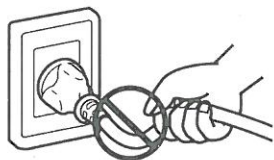

Remove the power cord from the power outlet by the plug, do not pull by the cord. This may damage the cords internal wiring and result in an electric shock or fire hazard.

Do not cover the air outlet and air inlet with a cloth, etc.



Poor ventilation can result in heat generation and subsequent fire.

When cleaning the dehumidifier, turn off the power and be sure to disconnect the power plug from the outlet.



A fan is rotating at a high speed inside the dehumidifier during running, and therefore it can cause injuries.

Do not sit on the dehumidifier



Falling, toppling, etc., can result in injuries.

OBSERVED FOR SAFETY

■ Points to be observed during operation.



CAUTION

(Mishandling can result in bodily injury or lead to the damage of a house, household effects etc.).

If the dehumidifier is not in use for an extended period of time, remove the power plug from the outlet.

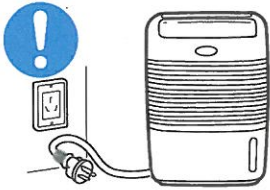

This is necessary to prevent electric shock and/or fire.

Do not use the power cord tied up in a bundle.

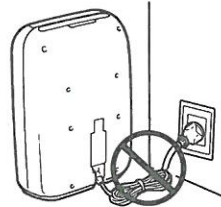

Otherwise, generated heat can result in fire.

When relocating the dehumidifier, be sure to stop operation, and discard the water in the drain tank.



Water in the drain tank can leak down to the floor in the room, wetting household effects, etc., and can result in electric shock and/or fire.

Do not wash the dehumidifier with water.



Washing the dehumidifier with water can result in electric shock.

Do not remove Styrofoam of the float.



If it is removed, the float cannot detect the level of water filled to the brim, permitting water in the drain tank to leak down to the floor in the room, wetting household effects, etc., and resulting in electric shock and/or fire.

When using the hose for the first time after storage or if it is used for continuous drainage, check periodically that the drain hose has not been blocked by foreign material.

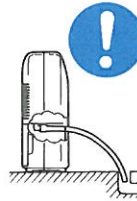

If objects block the hose it can result in water leakage. Check the hose on a regular basis when using the unit, or when it has been in storage for an extended period of time.

■ Points to be observed in repair



WARNING

(Mishandling can result in bodily injury or lead to the damage of a house, household effects etc.).

In case of abnormal operation (burning smell etc.), stop the unit, unplug from the power outlet and refer the unit to qualified service personnel.

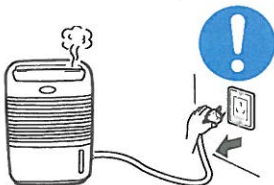

Continued running disregarding abnormality can result in machine failure, electric shock and/or fire.

Do not repair, disassemble or remodel the dehumidifier by yourself.



Such actions can result in electric shock and/or fire.

MAIN FEATURES OF THIS DEHUMIDIFIER

Automatic Dehumidifying Running.



High humidity.....high
Slightly high humidity.....low
Optimum humidity.....stop

- Dehumidification is performed according to the temperature and humidity in the room due to the function of the temperature/humidity sensor.

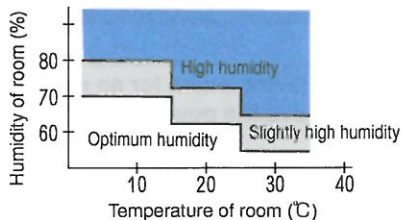

Large Volume Tank of 4.0 L with Automatic Tank Full Stop Device



A larger tank

- Water is accumulated in the drain tank by dehumidification. When the tank is filled with about 3.5 L of water, operation is automatically stopped, notifying you by a tank full lamp (red) and a tank full buzzer (beeping sound).

Humidity Sign.



Optimum humidity..... 1 lamp lights on
Slightly high humidity..... 2 lamps light on
High humidity..... 3 lamps light on

- A temperature/humidity sensor is incorporated into this dehumidifier. When in Automatic Dehumidifying mode, dehumidification is performed according to the temperature and humidity in the room due to the function of the temperature/humidity sensor. At this time the LOW-HIGH humidity lamps will light depending upon the measured humidity.

Air-Purifying Function



- An air filter that eliminates dust and dirt in the room and a deodorising/air-purifying filter that gets rid of cigarette smoke are built into this dehumidifier. Air purification can be performed during dehumidifying or independently.

POINTS TO BE NOTED BEFORE OPERATION

1

Dehumidification performance will vary according to the house size, structure, humidity and temperature levels within the home.

Year round daily use is recommended for maximum performance.

2

Place the dehumidifier on a floor that is horizontal and sturdy.

A weak floor can result in vibration and noise. If the main unit is tilted or laid down, water accumulated as a result of dehumidification can leak, resulting in the failure of the compressor.

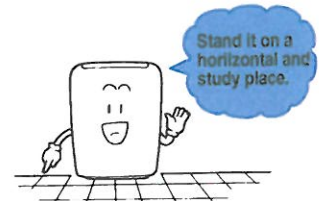

3

Do not place any obstacle near the air outlet.

This advice is to prevent deteriorated performance or abnormal running.



4

Running is stopped automatically in the following cases:

- (1) When the drain tank is full (about 3.5 L).
- (2) When the drain tank is removed. Running stops in 3 seconds after the removal of the drain tank.

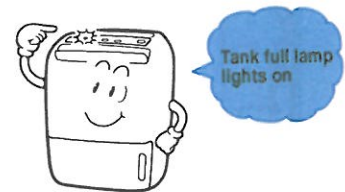

5

This dehumidifier is not for use when retention of low humidity is particularly desired. (Below 40%-50%).

This dehumidifier is designed to eliminate moisture that may not be required in normal daily life. Avoid the use of this dehumidifier for special applications such as the storage of foodstuffs, animals and plants, precision instruments, art objects, etc. There could be a risk of quality deterioration.

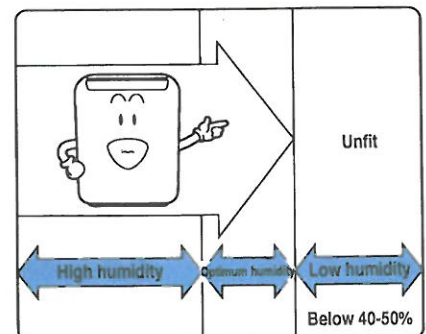

NAMES AND FUNCTIONS OF

Main Unit

Humidity Lamp (Orange)
During operation, the humidity of the room is indicated in three steps.

Handle
Grip this handle to carry.

Operation Panel

Air outlet
Dehumidified and purified air is blown out. When the power button is pushed [ON] the louvre opens. The blowout angle can be manually adjusted in two steps. (After use, push the power button [OFF] and close the louvre by hand. Do not close the louvre whilst the dehumidifier is operating.)

Air inlet
This is the inlet that draws in air and moisture from the room.

Air Filter
This filter eliminates dirt and dust contained in the drawn in air. Clean this air filter at least once every two weeks.

Deodorising / air-purifying filter
Fine dust and dirt such as cigarette smoke and pollen, etc., are eliminated.
(Replace with a new filter every 4-5 months. (Refer to Page16))

Float
This float detects when the drain tank is full. (Do not remove the float.)

Water Gauge

Drain Tank (with a handle)
Dehumidified water is reserved in this tank. (The handle is convenient to carry the drain tank. Discard water from the side of the float).

At the time the dehumidifier is purchased, there are cases where water may remain in the drain tank. This is due to the dehumidification tests conducted at the factory, and so is not abnormal.

Louvre

Front Door
To open, lightly pull the door.

Power Plug Cord
The power cord can be extended up to the maximum length of 1.8 m.

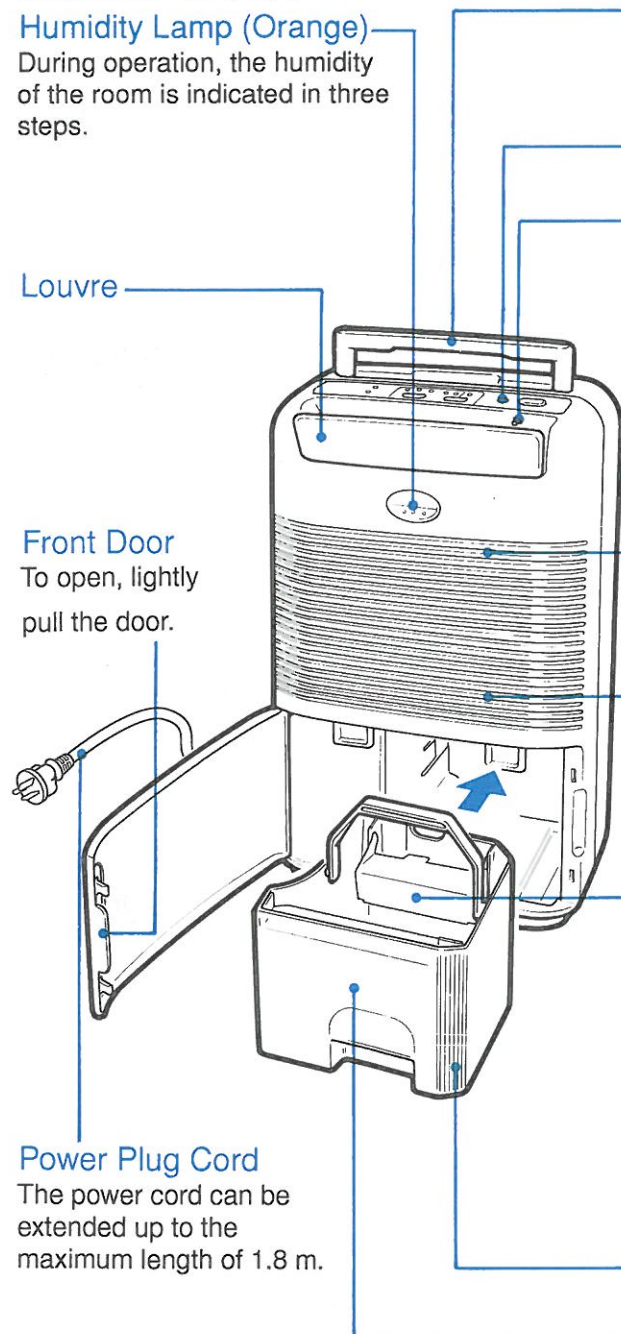

VARIOUS COMPONENT PARTS

Operation Panel

Tank Full Lamp (Red)

When the drain tank is full, the "tank full" lamp will light and the buzzer will sound. (If you do not want the "tank full" buzzer to sound, press the automatic dehumidifying button for 3 seconds. A long "beep" will be heard indicating that the buzzer has been turned off).

Defrosting Lamp (Red)

This lamp will light during defrosting.

Timer Lamp (Orange)

The timer hour lights depending upon the setting.

Power Lamp (Green)

Automatic dehumidifying button (With a green lamp)

Every time this button is pushed the unit will toggle between set and release.

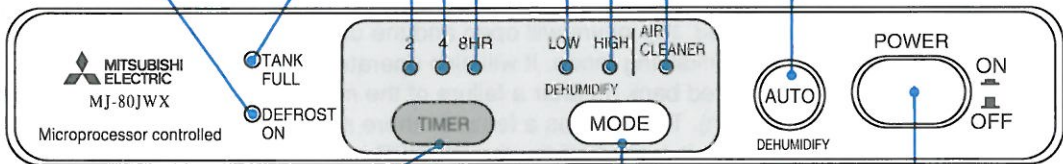

Timer Button

Use this before going to bed. Operation stops when the OFF TIME has elapsed.



Lamps will light depending upon the OFF TIME selected (No lamp indicates continuous operation).

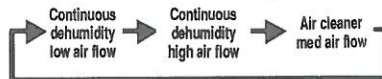

Each time the MODE button is pressed, one of the indication lamps will light depending upon the mode selected.

Power Button

When this button is pushed on, the louvre opens and operation starts. Each time this button is pressed the unit will toggle between [ON] and [OFF].

How to Extract and Insert Drain Tank

How to extract it

Open the front door. Hold the handle and gently pull it out the front.

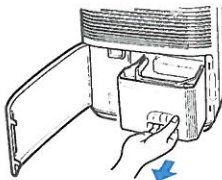

How to insert it

Tilt the drain tank down slightly at the front. Insert the tank until it contact the back of the unit.

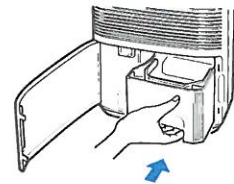

⚠ Caution

Do not remove the Styrofoam of the float.

DEHUMIDIFYING OPERATION

- Make sure that the drain tank is properly inserted into the dehumidifier. If the drain tank has not been installed correctly the unit will not operate and the "tank full" lamp will light.

1 Insert the power plug into the outlet.

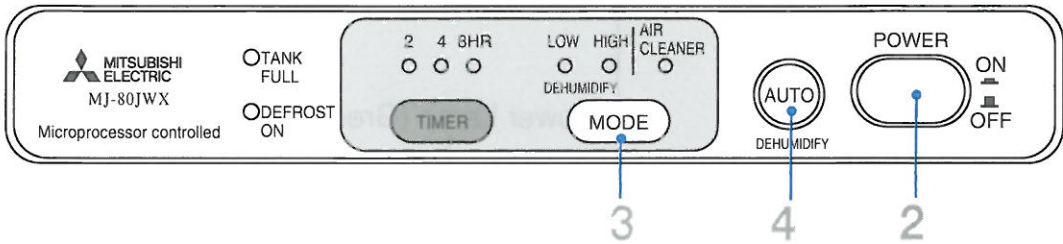

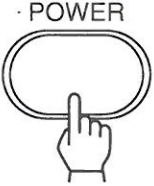
2  Push (ON)

- When the unit is plugged into the power outlet and the POWER button pressed, the louvre will open and the unit will operate in Automatic Dehumidifying mode. It will also operate in this manner when the unit is powered back on after a failure of the mains power supply (for what ever reason). The unit has a feature where it memorises its mode of operation if the unit is turned off (by the POWER button only). This means that when the power is turned back on (provided the mains power supply has not failed), the unit will restart in the mode it was operating in prior to the POWER button being pressed and the power being turned off.

If the louvre does not open by itself, open it by hand. (If the dehumidifier is operated with the louvre closed, the temperature inside the main unit will rise and the unit will be automatically stopped.)

Automatic Dehumidifying Mode

The dehumidifier operates whilst keeping the optimum humidity level according to the temperature in the room due to the function of the temperature/humidity sensor. It is designed so that lower humidity is kept at a high temperature and higher humidity is kept at a lower temperature. This maintains a comfortable humidity level. (Refer to Page 6).

3  Push

- When automatic dehumidifying is stopped, the fan will run at high speed. The HIGH lamp will light.
- Each time the MODE button is pressed, the mode changes between Low, High and Air-cleaner.

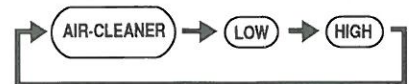

Indication lamp		Details of operation
AIR-CLEANER		Turns to independent air purification operation, and engages in air purification only.
Continuous	HIGH	Set the fan speed to HIGH while dehumidifying. This helps to dry laundry. Note that operating noise will increase.
	LOW	Set the fan speed to LOW whilst dehumidifying and operating noise will be reduced.

(Air Purification Operation is simultaneously performed.)

- To change from manual dehumidifying to automatic dehumidifying press the AUTO button.

4



Push

- The dehumidifier performs automatic dehumidifying.

To Stop

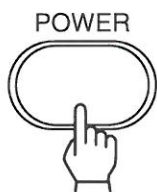

Push
(OFF)

- Close the louvre by hand.

- ※ To restart operation, press the POWER button. Provided the mains supply has not been interrupted, the unit will operate in the mode prior to the power being turned OFF.
- ※ If the power plug is disconnected and reconnected to the mains outlet, the unit will not start dehumidifying for about three (3) minutes. To protect the unit from damage, the compressor will not operate during these three minutes. When the compressor is operating, the level of noise will increase.

AIR PURIFICATION OPERATION

(Air purification is performed independently.)

- ※ The operational procedures are identical to those mentioned on Page 10.
- ※ Select “air-cleaner” by pressing the MODE button. The “air-cleaner” lamp will light.

Note

For the deodorising/air purifying process to operate correctly the deodorising/air purifying filter must be installed properly.

TIMER OPERATION

- It is possible to select the timer-setting of 2 hours, 4 hours, and 8 hours. Select the operational mode first and then set the OFF-TIME by pressing the **TIMER** button.

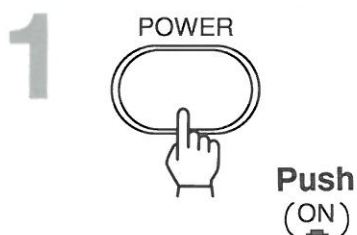
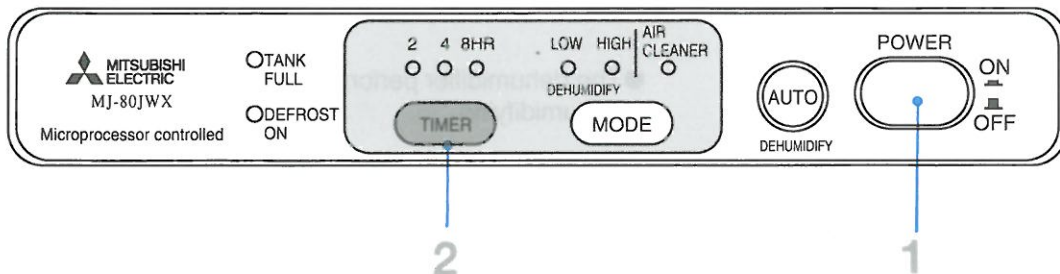

- Make sure you have selected the desired mode of operation.
- To change the mode of operation press the **MODE** button.



- The timer lamp will light.
- Each time the **TIMER** button is pressed, the mode of operation changes as

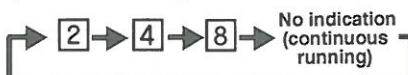

- The timer lamp turns off when the off-time elapses.

How to Release timer.



- Press the **TIMER** button until the **TIMER** lamp turns off. The unit will now operate in continuous mode. Refer to Page 10.
- To change the mode of operation, press the **MODE** button. Refer to Page 10.

Suspension of Off-timer Operation

- When the selected OFF-TIME (2, 4, or 8 hour lamp lit) has elapsed, the unit will switch OFF.
- To restart the unit, press the **POWER** button OFF then back ON again.

HOW TO DRAIN CONTINUOUSLY

- The dehumidifier can be used with drain tank installed or by connecting an external drainage hose (continuous drainage). If the drain tank is full, the “tank full” lamp will light and the unit will stop.
- When continuous drainage is used, observe the following instructions.

1 Cut open the hole in the back of the unit with a pair of nippers, etc. (see diagram). Through this hole a drainage hose can be passed.

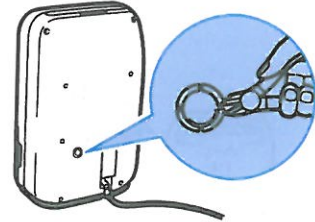

2 Pass the hose through inserting hole and over the drain elbow. You can use any hose sold on the market (with an inner diameter of 15 mm). Insert the hose completely up to the drain elbow. Also check if there is any water leakage.

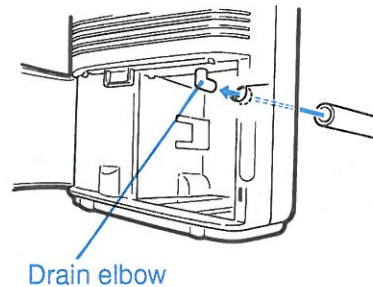

3 The drain hose must be installed with a downward inclination, (see diagram). If the drain hose is not installed correctly the “tank full” detector may be enabled and the unit will stop.

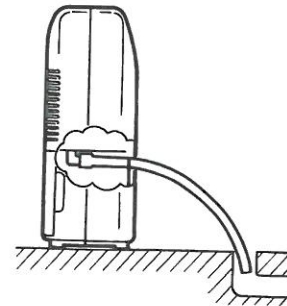

4 Replace the drain tank.

OPERATION AND PERFORMANCE

Regarding Working Temperature

- Only use the dehumidifier when the room temperature lies within $-1-40^{\circ}\text{C}$. Operation in a room outside this parameter, will cause the unit to stop.

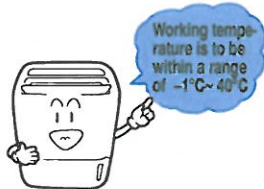

- If the room temperature falls below -2°C , dehumidifying is stopped and operation is restricted to air blowing only.

Regarding Defrosting Operation

- Sometimes the unit will not blow air and the "defrost" lamp will light. This is normal and indicates that the unit is in defrost mode. Defrosting will occur once an hour when the room temperature falls below 16°C . It will last for about 5 minutes.

The Principle of Dehumidification

- When cold water is poured into a glass, the surrounding air is cooled, and water drops are formed on the surface of the glass. The dehumidifier makes use of this phenomenon and eliminates moisture.

- ① Air is taken from the room and cooled by a cooler.
- ② Moisture from the air forms water droplets that collect in the drain tank.
- ③ The dehumidified air is warmed by a heater and then blown out.

- By repeating the above-mentioned steps of ①, ② and ③, the moisture in the room is eliminated.

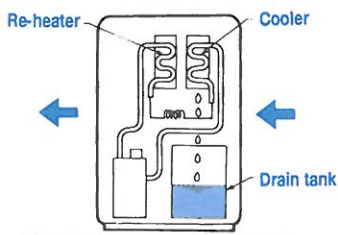

Regarding Amount of Dehumidification

- As the temperature falls, the amount of dehumidification decreases.

Heat is Generated during Operation

- The dehumidifier will generate some heat during its operation. This is normal. If the unit is used in a closed environment with other electrical appliances, the room temperature may rise between $2-3^{\circ}\text{C}$. If the increased temperature makes you feel uncomfortable discontinue use of the dehumidifier.

Principle Of Air Purification

- Fine dirt, dust and cigarette odours are eliminated by the use of a deodorising/air-purifying filter and static electricity.

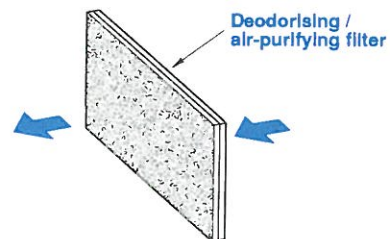

- Note that carbon monoxide and toxic gases cannot be eliminated. Therefore ensure proper ventilation when using the dehumidifier in such an environment.

SMART WAYS TO USE

Dehumidifying running

Eliminate moisture in mats and carpets.



- Use the dehumidifier when mats and carpets are damp due to a rainy season or prolonged rain.

Use the dehumidifier to prevent mold in clothing and leatherwear.

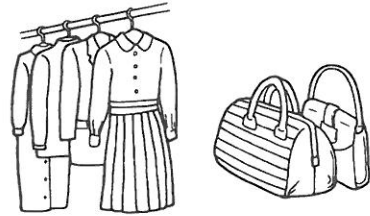

- Run the dehumidifier in a situation where all the drawers of cabinets are open.

Prevent dew condensation on ceilings and window panes.



- Minimise the opening and closing of windows and doors in the room because the incoming air will reduce the dehumidifying effect.

Use the dehumidifier in the home where there are moisture-sensitive music instruments.

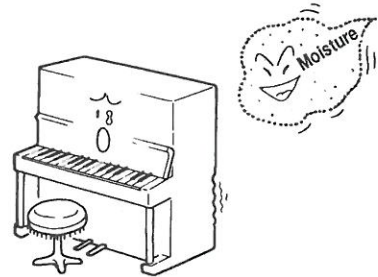

Use the dehumidifier to eliminate moisture in a closet, etc.

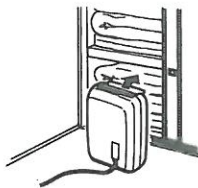

- Open the sliding door and run the dehumidifier right in front of the closet. When the air outlet is aimed at the closet, moisture can be eliminated much faster.

Use the dehumidifier when you go out.



- Make the best use of the timer operation before going to bed or going out.

Use the dehumidifier as an aid to dry the laundry.



- Make use of a space in the laundry, bath room, etc., to set the dehumidifier with the louver adjusted "upward" so that the wind can hit the clothing directly. Smaller space allows faster drying.

Air-Purifying Operation

For the homes of regular smokers



How to Clean Air Filter

- Clean the air filter normally once every two weeks.
 1. Take out the drain tank.
 2. Grip the handle of the air filter and draw it down.
 3. Remove the deodorising/air-purifying filter from the air filter.

4. Lightly slap on the air filter to dust it or clean it with a vacuum cleaner.

In case of a heavy stain

Rinse the air filter with lukewarm water or plain water that contains a neutral detergent. Then wash the detergent away with clean water.

5. After completely drying the air filter, replace it into the unit.

Do not wash the deodorising/air-purifying filter with water.

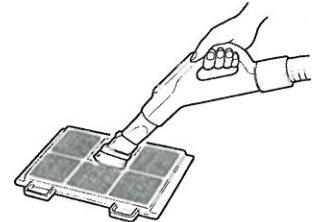
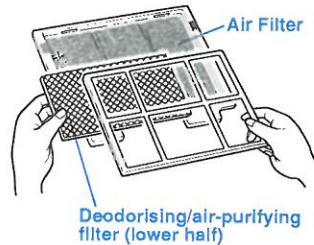
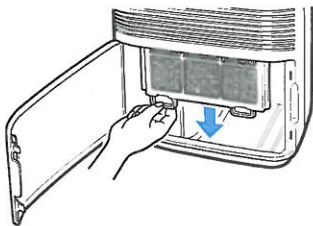

How To Replace Deodorising/Air-Purifying Filter

Place the deodorising/air-purifying filter between the air filter and the filter weight. Firmly press the air filter and filter weight together.

The deodorising/air-purifying filter is disposable. The life of the filter differs according to the environment in which it is used. Usually this period will be about 4-5 months. After this period, replace it with a new filter (sold separately). If during this 4-5 month period, the white portion of the filter becomes a brownish or dark colour, replace it with a new one.

- The deodorising/air-purifying filter should never be soaked in or washed with water.
- Continued use of a clogged or stained deodorising/air-purifying filter can result in unsatisfactory air flow and dehumidification.

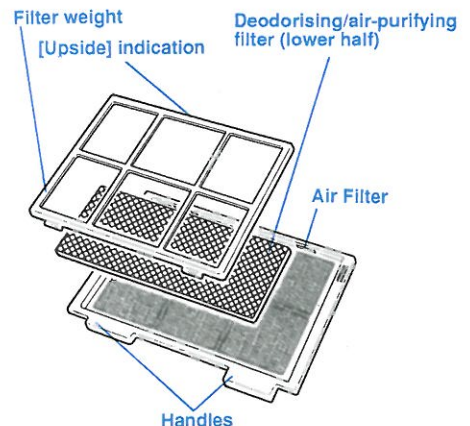

Part Sold Separately

- Available at your nearest Mitsubishi Dealer.
Deodorising/Air-Purifying Filter
(Model MJPR-LHXFT)

How to Clean Main Unit

■ Wipe off the main unit with a dry soft cloth.



■ DO NOT use gasoline, benzene, thinners, polishing powder, chemical rags, detergents, etc., for cleaning as they can damage the product.

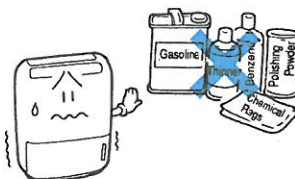

When Not Used For a Long Time

1. Stop operation and disconnect the power plug from the outlet.
2. Tie up the power cord in a bundle.
3. Discard the remaining water in the drain tank.
Wipe off the remaining water drops.

4. Clean the air filter.
5. Keep the dehumidifier upright under a cover at a place that is not exposed to direct sunlight.

● Specifications

Model	MJ-80JWX-A1
Power Supply	Single phase 230 – 240V 50 Hz
Dehumidifying Capacity	12 L / day
Power consumption	210 W
Drain tank capacity	4.0 L (automatic stop at about 3.5 L)
Mass	9.9 kg
Dimensions (height × width × depth)	525 mm × 340 mm × 195 mm

- The value of the standard area that can be dehumidified is based on the JIS (JIS C 9617).
- The Dehumidification capacity is the value obtained after the dehumidifier was continuously run in the room temperature of 30°C with the relative humidity of 80%. The indicated amount of dehumidification is per one day (24 hours).

TROUBLESHOOTING GUIDE

■ Before contacting your dealer for service, please check the following points:

Conditions	Points to be checked	Remedies	
The dehumidifier does not run	Check if the power plug is properly inserted in the outlet.	Insert the power plug into the outlet.	10
	Check if the tank full lamp is ON.	Discard the water in the drain tank and replace the drain tank.	9
	Check if the drain tank is properly inserted.	Replace the drain tank properly.	9
	Check if it is during the time the defrosting lamp is ON.	It is because defrosting is working. The dehumidifier starts running after the defrosting operation is finished.	9, 14
The amount of dehumidification is small	Check if the screens of the air filter are clogged up with dust.	Clean according to the methods described on Page 16.	16
	Check if the air outlet or air inlet is blocked up by some obstacles.	Remove the obstacles that block up the air outlet or air inlet.	4, 7
No air blow	Check if the screens of the air filter are clogged up with dust.	Clean according to the methods described on Page 16.	16
	Check if it is during the time the defrosting lamp is ON.	The unit is in defrost mode. Wait about 5 minutes and the unit will restart after defrosting is completed.	9, 14
Noisy	Check if the main unit is securely set.	Set and use the dehumidifier at a sturdy and horizontal place.	2, 7

■ The Following Symptoms are Not Failures:

Phenomenon	Reasons
The room is hardly dehumidified.	Perhaps the room is spacious. Refer to Page 7. There are numerous windows and doors being opened and closed too often. Appliance that generates steam such as a kerosene stove is being used in the room.
The amount of dehumidification is small.	This can happen when the temperature and humidity of the room are low. Refer to Page 14.
The blown out air smells in the beginning.	The dehumidifier can sometimes give off a smell. This can be due to a momentary rise in the temperature of the heat exchanger.
The Dehumidifier resonates.	The dehumidifier may resonate if it is operated in a narrow room or on a bare wooden floor.
Sometimes hissing and booming sounds can be heard inside the main unit of the dehumidifier at the start of operation or at the time of changing operational modes.	Circulating coolant can cause some noise. It will subside once the coolant has stabilised.
The level of noise increases abruptly while the unit is operating.	When the compressor begins to operate the level of noise can increase. This occurs in about 3 minutes after the unit is turned on, or intermittently when automatic dehumidifying is selected.

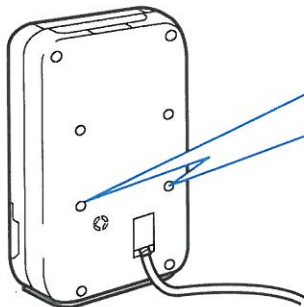

NOTE

It is impossible to remove the rear panel because the two spots shown on the left figure are fastened with two special screws. When the unit is out of order, contact the following service centers:

**Distributed throughout Australia by:
 MITSUBISHI ELECTRIC AUSTRALIA PTY. LTD.
 (INCORPORATED IN NEW SOUTH WALES)
 A, C, N, 001 215 792**

New South Wales
 348 Victoria Rd,
 Rydalmere 2116
 Phone: (02) 96847777

Queensland
 Unit 1, 104 Newmarket Rd,
 Windsor 4030
 Phone: (07) 33578877

Western Australia
 329 Collier Rd,
 Bassendean 6054
 Phone: (09) 3773400

**South Australia/
 Northern Territory**
 77 Port Rd,
 Hindmarsh 5007
 Phone: (08) 83402000

**Victoria/
 Tasmania**
 Unit 4, 303 Burwood Hwy,
 East Burwood 3151
 Phone: (03) 32629800

**Distributed and guaranteed throughout New Zealand by:
 MELCO NEW ZEALAND LTD.**

Auckland
 Unit 1, 4 Walls Rd,
 PO Box 12726 Penrose
 Auckland
 Phone 09 5253120
 Fax 09 5253116

Wellington
 1 Padiament St,
 PO Box 30772
 Lower Hutt
 Wellington
 Phone 04 5609100
 Fax 04 5609131

Christchurch
 Unit 1, 3 Birmingham Dr,
 PO Box 1604
 Addington
 Christchurch
 Phone 04 3386591
 Fax 04 3386491